

# CENTAUR



(NASA-CR-154970) CENTAUR MISSION PLANNING  
GUIDE (General Dynamics/Convair) 89 p

N77-84212

00/15    Unclas  
43857

## Mission Planners Guide

**GENERAL DYNAMICS**  
*Convair Aerospace Division*

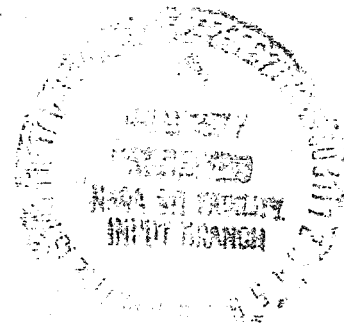

# CENTAUR

## Mission Planners Guide

August 1971

### LAUNCH VEHICLE PROGRAMS

CONVAIR AEROSPACE DIVISION OF GENERAL DYNAMICS  
San Diego, California

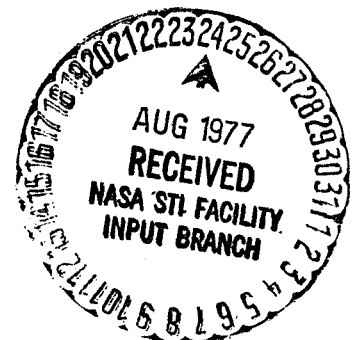

I am pleased to present this Mission Planners Guide to the many potential users of the Centaur launch vehicle. Centaur is built by Convair Aerospace under direction of the NASA Lewis Research Center. It has one purpose — to reliably and accurately place your spacecraft where it can accomplish its mission.

This guide tells you what you can expect from Centaur and how the Centaur agencies will work with you. It includes essential data for mission preliminary planning and analysis and spacecraft predesign; plus a comprehensive view of spacecraft/launch vehicle interrelationships from program initiation to achievement.

This is an exciting era for Centaur. In process are improvements that will result in even greater flexibility and capability. The Centaur D-1 will be the high-energy upper stage for both Atlas and Titan. In addition, growth versions of Centaur are under study to meet the projected needs in the mid 70s and into the shuttle era.

Centaur's future assignments are to the spacecraft that stretch man's imagination to the fullest. Mars landers . . . Pioneers traveling through the asteroid belt past Jupiter . . . a scan of Mercury with a swing by Venus on the way . . . a probe to the sun itself . . . more Intelsat IVs — these are some of the missions assigned to Centaur D-1.

We welcome the opportunity to discuss Centaur's potential application to your program. Please direct any requests for further information to:

Pat O'Leary  
Manager, Program Development  
Launch Vehicle Programs

Convair Aerospace Division  
General Dynamics Corporation  
P.O. Box 1128  
San Diego, California 92112  
(714) 277-8900, ext. 2483



---

Ken Newton  
Director, Launch Vehicle Programs  
August 2, 1971

# CONTENTS

<b>CENTAUR STATUS AND PLANS</b>	
Centaur D-1	1-1
Development	1-2
Record of Atlas and Centaur	1-3
Missions Performed by Atlas/Centaur	1-4
Coming Missions for Centaur D-1	1-6
<b>CENTAUR D-1</b>	
Centaur Systems Summary	2-1
Structure and Pneumatics	2-1
Propulsion	2-3
Astrionics	2-4
Centaur Systems Variations	2-8
<b>ATLAS/CENTAUR</b>	3-1
Atlas/Centaur D-1A Summary	3-3
Launch Vehicle Description	3-4
Performance	3-5
Atlas/Centaur Flight Profile	3-6
Accuracy	3-11
Atlas/Centaur Standard Fairing	3-13
Interfaces	3-15
Environment	3-18
Launch Facilities	3-21
Procurement and Manufacture	3-24
<b>TITAN/CENTAUR</b>	4-1
Titan/Centaur D-1 T Summary	4-3
Launch Vehicle Description	4-4
Performance	4-5
Titan/Centaur Flight Profile for Two-Burn Mission	4-6
Accuracy	4-10
Centaur Standard Shroud	4-10
Interfaces	4-11
Environment	4-13
Launch Facilities	4-15
Procurement	4-18
<b>PAYLOAD/LAUNCH VEHICLE INTEGRATION</b>	
Organizations and Responsibilities	5-1
Factory-to-Launch Procedures	5-5
Spacecraft ETR Facilities	5-8

**CENTAUR EXTENSIONS AND GROWTH**

<b>Centaur GT</b>	<b>6-1</b>
<b>Growth Boosters</b>	<b>6-3</b>
<b>Centaur Orbit-to-Orbit Shuttle</b>	<b>6-3</b>

**GLOSSARY AND INDEX**

<b>Glossary</b>	<b>7-1</b>
<b>Index</b>	<b>7-3</b>



## CENTAUR STATUS AND PLANS

### CENTAUR D-1

These are hallmarks of the Centaur D-1:

High-energy liquid hydrogen and oxygen propellants for top performance.

Efficient pressure-stabilized stainless steel structure for high stage mass fraction.

Advanced inertial guidance and control hardware and software for pinpoint accuracy and flexibility.

Proven record of reliability and launch dependability for lunar, planetary, and earth orbit missions.

The Centaur D-1 is built by the Convair Aerospace Division of General Dynamics, with program management by the NASA Lewis Research Center (LeRC).

The Centaur D-1 space vehicle comes in two basic types: one for use with Atlas (designated by an A suffix) and the other for use with Titan (designated by a T suffix). The Atlas SLV-3D Centaur D-1A is launch vehicle for such programs as Intelsat IV, Venus-Mercury '73, and Pioneer G. Launch vehicle for the Viking Mars '75 mission and the Helios sun probe is the Titan/Centaur D-1T. The Grand Tour outer planet spacecraft will fly on Titan/Centaur.

Advancements incorporated into Centaur D-1 are scheduled for flight in late 1972. By that date the basic Centaur D will have performed 21 operational launches.

The changes that distinguish Centaur D-1 from Centaur D are primarily in the area of avionics and payload area structures. Particularly significant items in avionics are a new increased-capability digital computer unit, a repackaged inertial measurement unit, and newly designed electronics. Many former hardware functions are now done by the flight software, including a new software digital autopilot. Lower cost and greater mission flexibility has been achieved by this approach. In structures, alternate capabilities of payload adapters and fairings are available.

Centaur D-1T will be first flown on Titan in January 1974. Centaur's three-burn capability to synchronous orbit will be demonstrated with this proof flight. One of the Centaur D-1T improvements is added thermal radiation shielding, reducing hydrogen boiloff by a factor of 10 during coast phases.

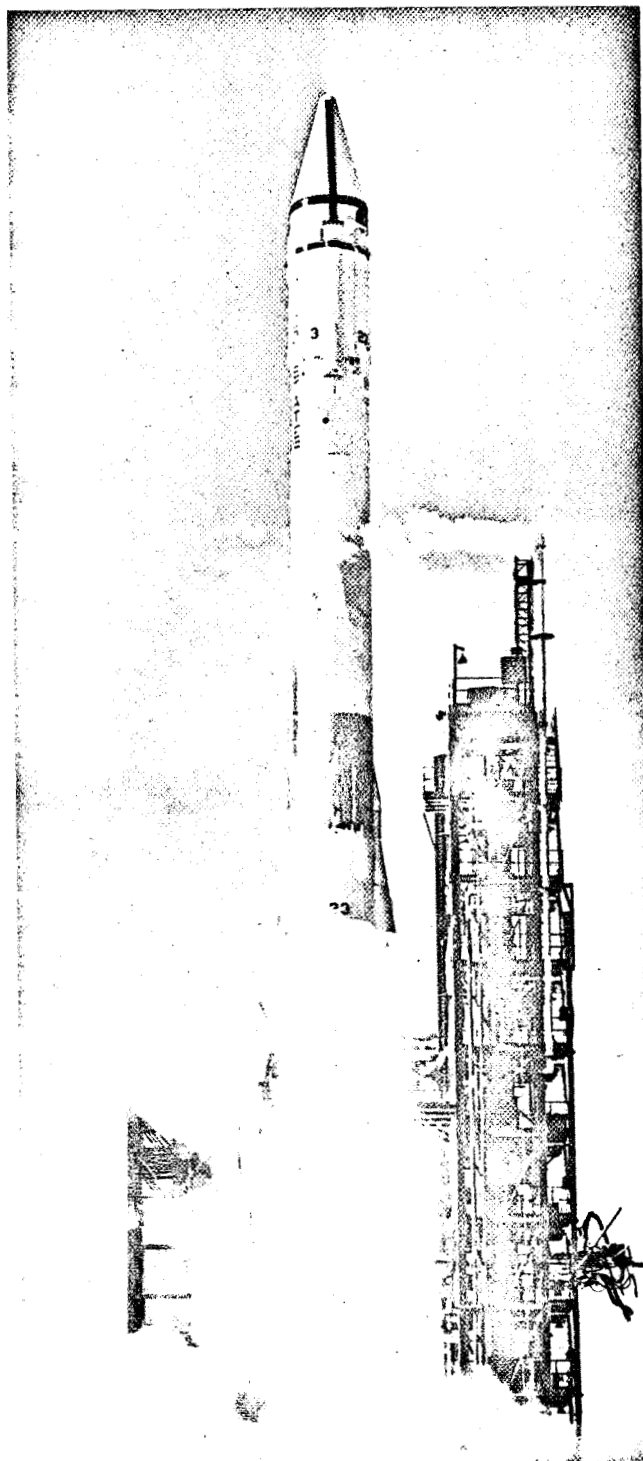

*Liftoff for Mars in May 1971*

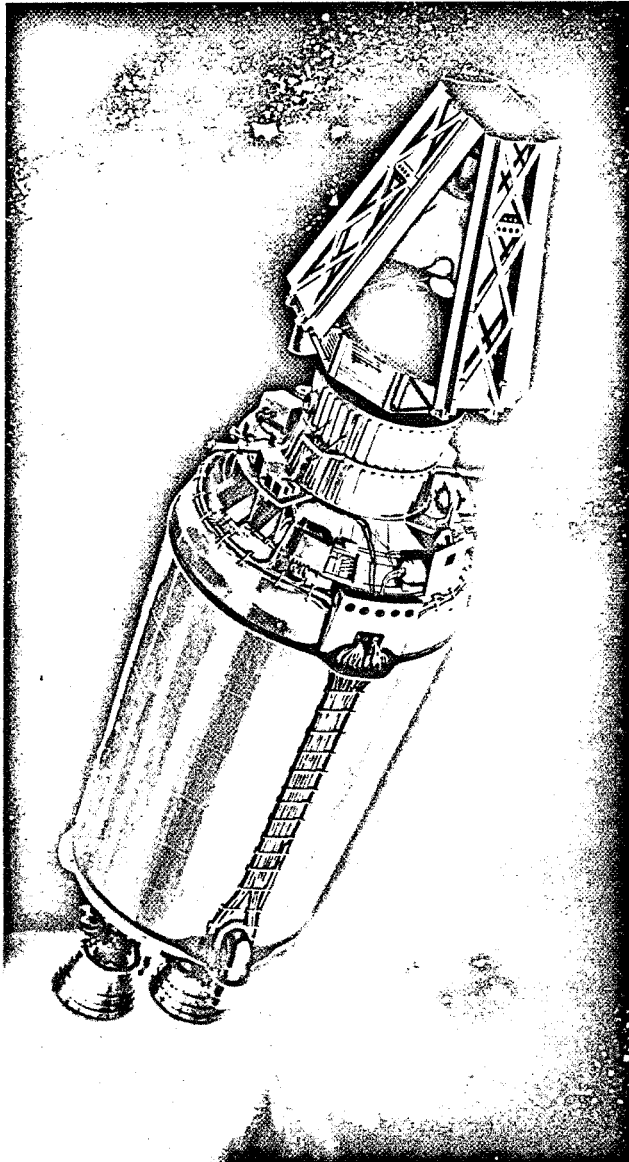

*Centaur with Mariner '71 Spacecraft*

## DEVELOPMENT

The Centaur D-1 update began in 1969, 11 years after the first Centaur contract was awarded to Convair Aerospace by the Advanced Research Projects Agency (ARPA).

As the first space vehicle to use liquid hydrogen fuel, Centaur required the development of a whole new

technology. The problem of materials, handling, behavior, fabrication, and testing for liquid hydrogen in a space application had to be solved not only to make Centaur a success, but also because this was the fuel planned for many elements of the Apollo program.

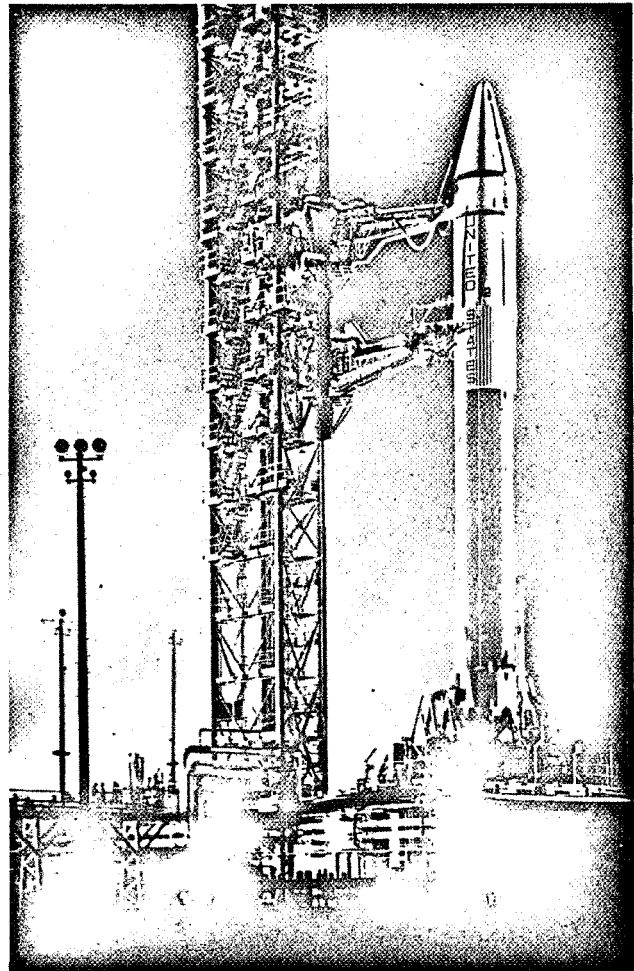

*Atlas/Centaur Ready for Surveyor Launch*

In 1958, Pratt & Whitney Aircraft was awarded a contract to develop Centaur's RL-10 engines. At this same time the U.S. Air Force built the first large quantity liquid hydrogen production facility. NASA's Lewis Research Center did much pioneering work in developing liquid hydrogen technology. LeRC had fired an experimental  $LO_2/LH_2$  engine of 5,000 pounds thrust in 1953.



In 1962, LeRC was assigned technical management of Centaur. At the same time the Centaur project was given a DX priority, the nation's most urgent aerospace priority. This reflected its importance to the Surveyor lunar exploration program and to the development of liquid hydrogen technology.

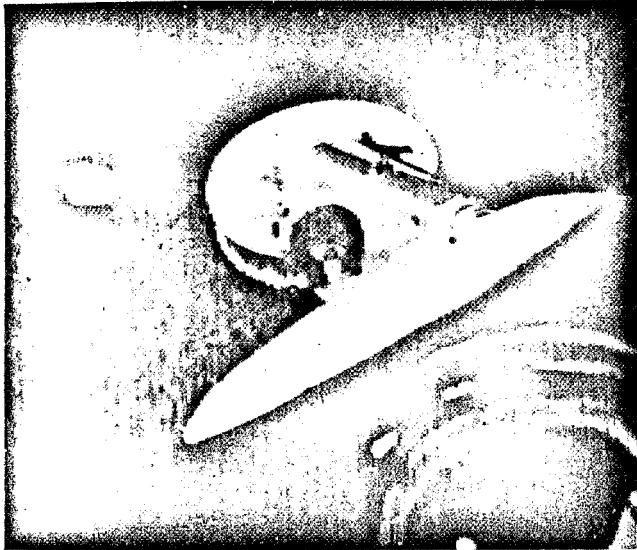

Surveyor Photograph of Landing Foot and Lunar Surface

The first successful flight of Centaur atop Atlas occurred in November 1963. This was the world's first in-flight firing of a hydrogen-powered vehicle.

Centaur's first mission was to inject Surveyor moon landers into their translunar orbit. The first operational Centaur mission, in May 1966, was an outstanding achievement. Surveyor I landed within eight miles of its lunar target.

Centaur performed the first successful space restart of liquid hydrogen engines in October 1966. With this flight, the Centaur R&D phase was completed.

#### RECORD OF ATLAS AND CENTAUR

The accomplishments of Atlas and Centaur are many. John Glenn and the other Project Mercury astronauts all

#### Atlas/Centaur Launch History

DATE	MISSION	VEHICLE	RESULTS
RESEARCH & DEVELOPMENT PHASE			
MAY 1962	CENTAUR	AC-1,	4 SUCCESSES 1 PARTIAL SUCCESS 1 NO TRIAL 2 FAILURES
TO	R&D	-2, -3,	
OCT 1966	PROGRAM	-4, -5	
		-6, -8,	
		-9	
OPERATIONAL PHASE			
1966			
MAY 30	SURVEYOR	AC-10	SUCCESS
NOV 20	SURVEYOR	AC-7	SUCCESS
1967			
APR 17	SURVEYOR	AC-12	SUCCESS
JUL 14	SURVEYOR	AC-11	SUCCESS
SEP 8	SURVEYOR	AC-13	SUCCESS
NOV 7	SURVEYOR	AC-14	SUCCESS
1968			
JAN 7	SURVEYOR	AC-15	SUCCESS
AUG 10	ATS-D	AC-17	NO CENTAUR 2ND BURN
DEC 7	OAO-A	AC-16	SUCCESS
1969			
FEB 24	MARINER MARS '69	AC-20	SUCCESS
MAR 27	MARINER MARS '69	AC-19	SUCCESS
AUG 12	ATS-E	AC-18	SUCCESS
1970			
NOV 28	OAO-B	AC-21	SHROUD JETTISON FAILURE
1971			
JAN 25	INTELSAT IV	AC-25	SUCCESS
MAY 8	MARINER MARS '71	AC-24	CENTAUR FLIGHT CONTROL FAILURE
MAY 30	MARINER MARS '71	AC-23	SUCCESS
_____	INTELSAT IV	AC-26	
_____	INTELSAT IV	AC-28	
1972			
_____	OAO-C	AC-22	
_____	PIONEER F	AC-27	
_____	INTELSAT IV	AC-29	
_____	INTELSAT IV		
1973			
_____	PIONEER G		
_____	INTELSAT IV		
_____	INTELSAT IV		
_____	VENUS/ MERCURY '73		
1974			
_____	INTELSAT IV		
_____			

rode into space aboard Atlas. The Air Force has called on Atlas for a variety of space missions, including a space surveillance program for which Atlas was successful in 37 out of 38 attempts.

Through June 1971, Convair Aerospace produced 538 Atlases; 393 have been launched, 146 for space launches. The current (June 1971) string of 53 consecutive successes for the Atlas space booster extends back five years to June 1966.

The moon and planets have been special domains for Atlas and Centaur. Atlas has provided liftoff for every unmanned lunar and planetary mission but one. Predecessors to the Apollo manned landings were the Lunar Orbiters and Surveyors. All five Atlas/Agenas and all seven Atlas/Centaurs were successful. The secrets of Mars have been methodically unlocked by spacecraft boosted by Atlas/Centaur in 1969 and 1971.

Atlas/Centaur has been the launch vehicle for a wide range of earth orbiting programs. The Applications Technology Satellite, Orbiting Astronomical Observatory, and the first Intelsat IV were launched by Atlas/Centaur.

Through June 1971, Atlas/Centaur has performed 16 operational launches.

## MISSIONS PERFORMED BY ATLAS/CENTAUR

Note: All weights are weight-separated from Centaur.

### SURVEYOR

Mission: First lunar soft landers  
Ascent Mode: One- and two-burn Centaurs  
SC Agency: Jet Propulsion Lab  
SC Contractor: Hughes Aircraft Co.

### ORBITING ASTRONOMICAL OBSERVATORY (OAO)

Mission: 405-mile circular observatory. The heaviest unmanned scientific satellite launched to date  
Ascent: Direct injection  
SC Agency: Goddard Space Flight Center  
SC Contractor: Grumman Aircraft Engineering Corp.

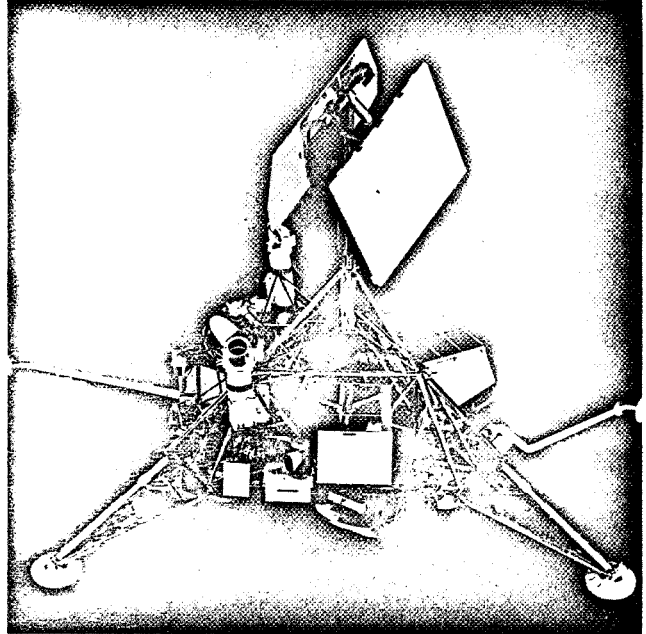

*Surveyor. Weight: 2,250 lb.*

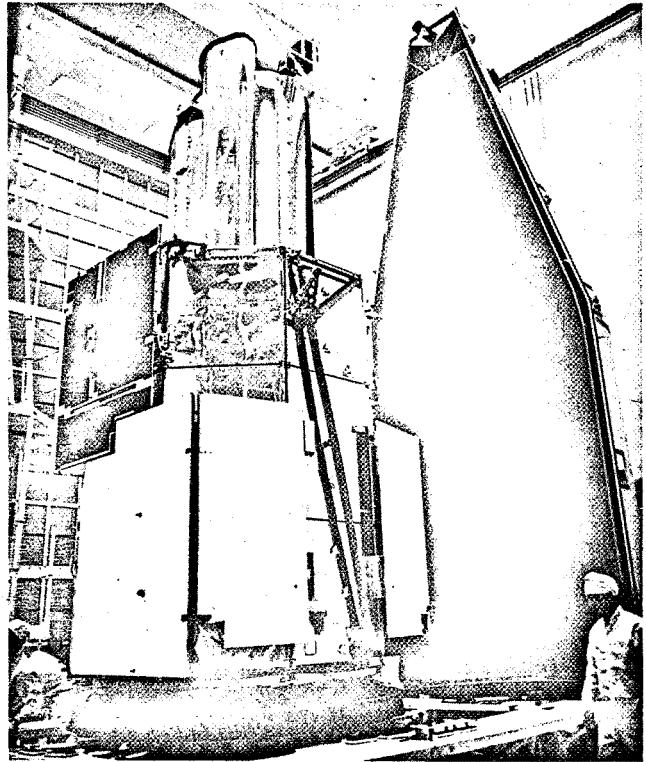

*Orbiting Astronomical Observatory. Weight: 4,400-4,800 lb., length: 204 in., diameter: 84 in. (folded)*

**MARINER '69**

Mission: Mars flyby  
Ascent: Direct ascent, the first for planetary missions  
SC Agency: Jet Propulsion Lab

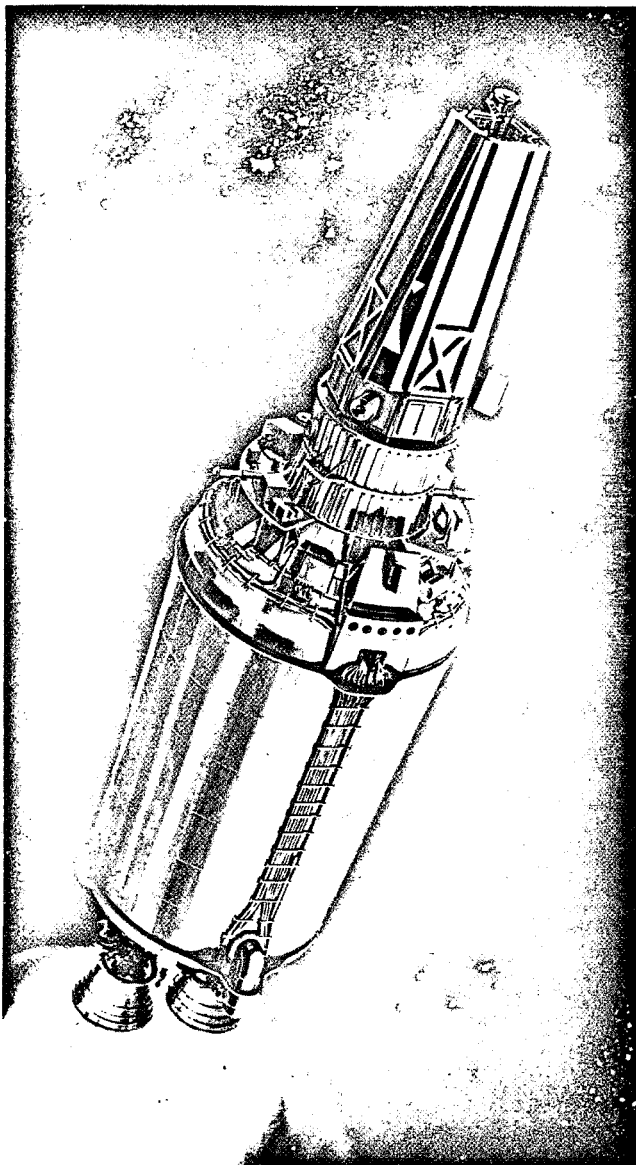

*Mariner '69. Weight: 850 lb., length: 131 in., diameter: 54 in. (folded)*

**APPLICATIONS TECHNOLOGY  
SATELLITE (ATS)**

Mission: Synchronous equatorial  
Ascent: Centaur two-burn plus SC apogee kick  
SC Agency: Goddard Space Flight Center  
SC Contractor: Hughes Aircraft Co.

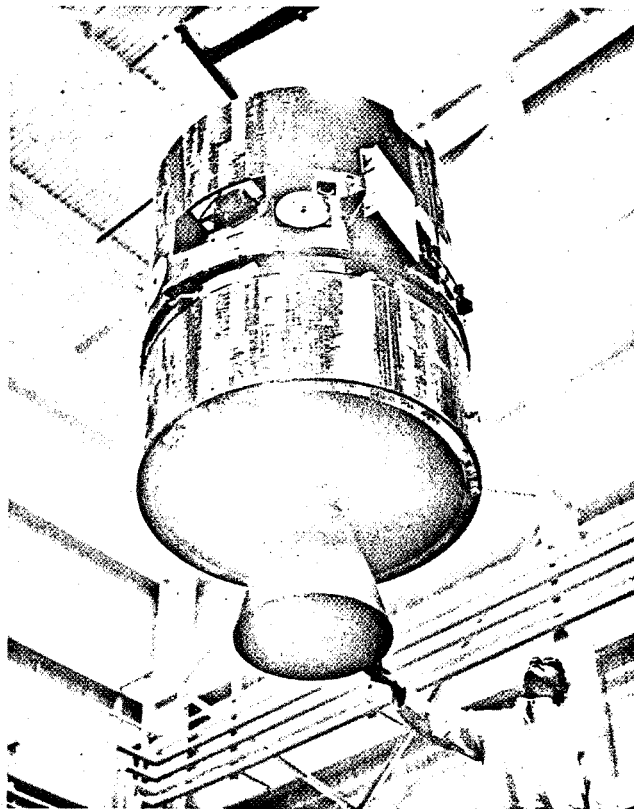

*Applications Technology Satellite. Weight: 1,900 lb., length: 72 in., diameter: 56 in.*

**INTELSAT IV**

Mission: Synchronous equatorial commercial communications satellite  
Ascent: Two Centaur burns plus SC apogee kick  
SC Agency: Comsat Corp.  
SC Contractor: Hughes Aircraft Co.

**MARINER MARS '71**

**Mission:** Mars orbiters to study dynamic characteristics of Mars  
**Ascent:** Direct injection  
**SC Agency:** Jet Propulsion Lab

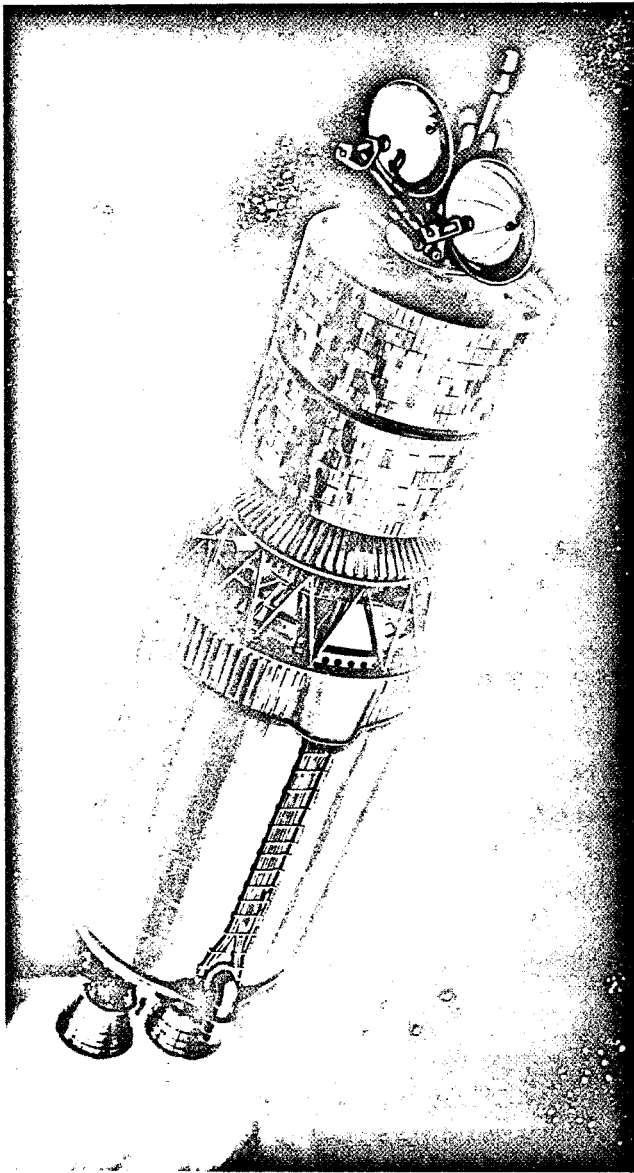

*Intelsat IV. Weight: 3,020 lb., length: 211 in., diameter: 93.5 in.*

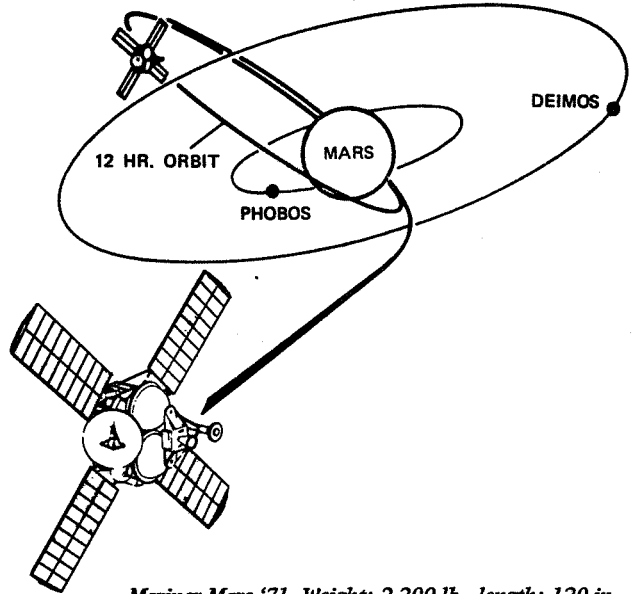

*Mariner Mars '71. Weight: 2,200 lb., length: 120 in., diameter: 54 in. (folded)*

**COMING MISSIONS FOR CENTAUR D-1**

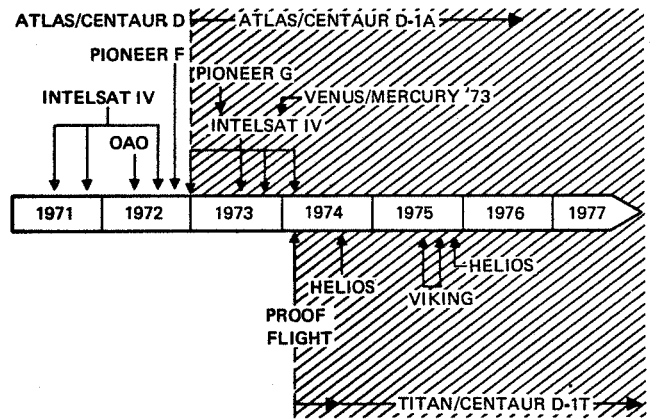

*Currently Planned Centaur Missions*

**INTELSAT IV**

Intelsat IV is a continuation of the Comsat Corporation's commercial communications satellites. The four launches scheduled for Atlas/Centaur D-1A are for synchronous apogee injection and include a spacecraft apogee kick to synchronous equatorial orbit.

**SC Agency:** Comsat Corp.  
**SC Contractor:** Hughes Aircraft Co.

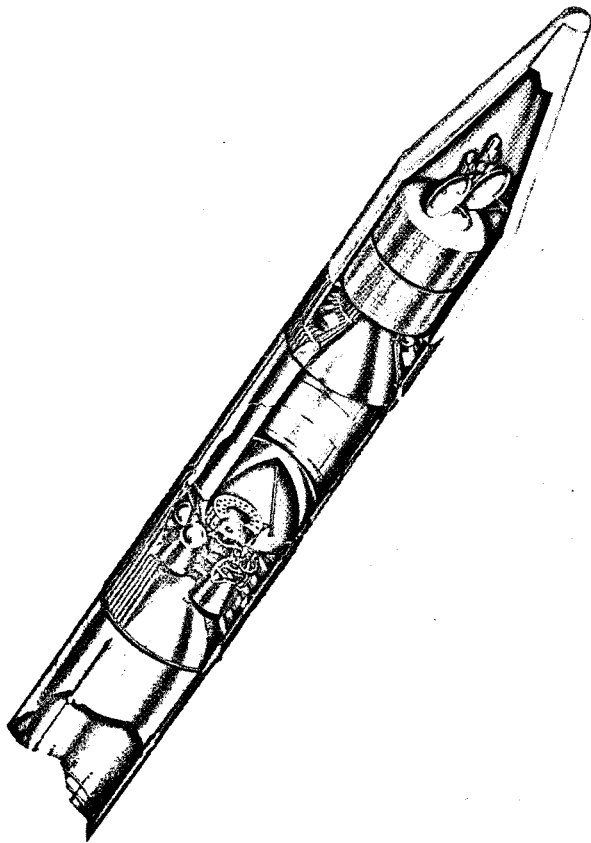

*Intelsat IV. Weight: 3,020 lb., length: 211 in., diameter: 93.5 in.*

**PIONEER G**

Pioneer G, which follows Pioneer F (to be launched by Atlas/Centaur D), will be a Jupiter flyby through the asteroid belt. Its primary objective is to obtain precursory scientific information beyond the orbit of Mars. The

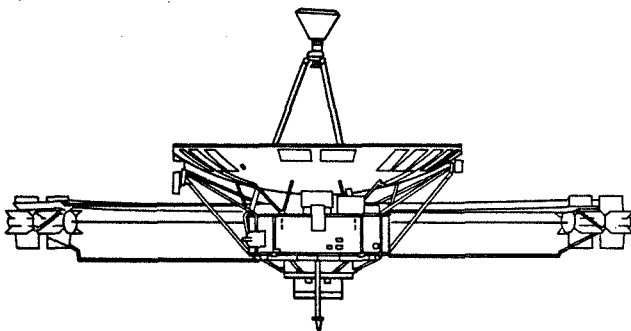

*Pioneer G. Weight: 3,094 lb. (SC weight of 550 lb.), length: 177 in., diameter: 108 in. (folded)*

mission entails direct ascent by Atlas/Centaur D-1A/TE-364-4, vis viva energy of about 84 km<sup>2</sup>/sec.<sup>2</sup>.

SC Agency: Ames Research Center

SC Contractor: TRW

**MARINER VENUS/MERCURY '73**

A Mercury flyby with gravity assist from Venus, this mission will investigate environment and characteristics of the two planets. The mission calls for parking orbit ascent by Atlas/Centaur D-1A with vis viva energy of about 21 km<sup>2</sup>/sec.<sup>2</sup>.

SC Agency: JPL

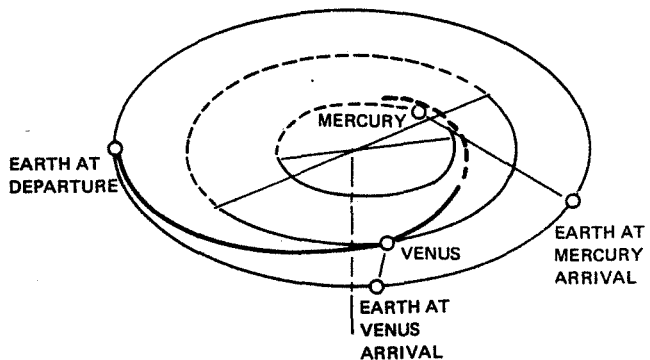

*Heliocentric Trajectory for Mariner Venus/Mercury '73. Weight: 900 to 1,100 lb. expected*

**COMING MISSIONS FOR CENTAUR D-1T**

**TITAN/CENTAUR PROOF FLIGHT**

The purpose is to verify the integrated launch vehicle. Added Centaur burns also will demonstrate three-burn synchronous mission capability.

**VIKING MARS ORBITER/LANDER**

This mission, comprising two launches, will advance the knowledge of Mars by observations from Martian orbit and direct measurements in the atmosphere and on the surface, with particular emphasis on evidence about the existence of life past, present, or future. The

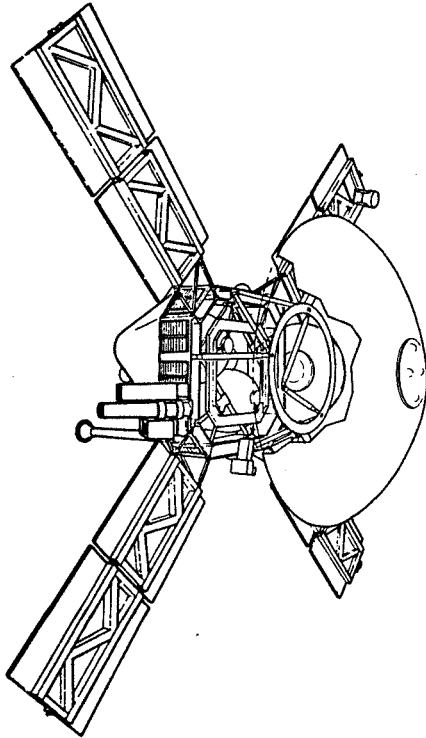

*Viking Spacecraft. Weight: 8,000 lb., length: 189 in., diameter: 137 in.*

Titan/Centaur D-1T entails two Centaur burns and vis viva energy of about  $18 \text{ km}^2/\text{sec}^2$ .

SC Agency: Langley Research Center  
 SC Contractor: Martin Marietta Corp. and JPL

**HELIOS**

Helios is a solar probe mission that comprises two launches atop Titan/Centaur D-1T/TE-364-4. Its primary

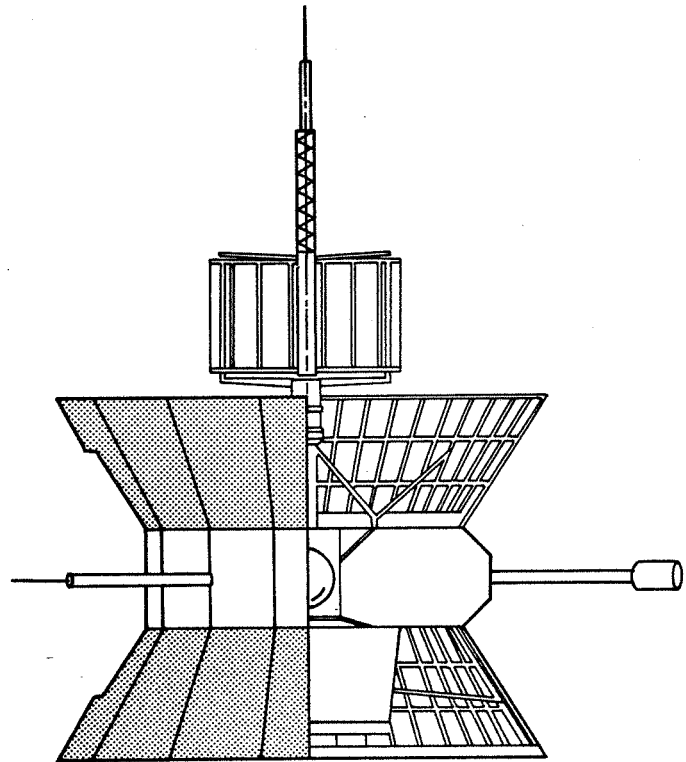

*Helios. Weight: 2,581 lb. (SC weight of 575 lb.), length: 150 in., diameter: 106 in.*

objective is to obtain scientific information and explore positions of the interplanetary region as well as the outer solar corona.

SC Agency: Goddard Space Flight Center and Gesellschaft für Weltraumforschung (West German Republic)  
 SC Contractor: Messerschmidt-Boelkow-Blohm



# CENTAUR D-1

## CENTAUR SYSTEM SUMMARY

### GENERAL

Length:	30 ft. (without fairing)
Diameter:	10 ft.
Guidance:	Inertial
Propulsion:	P&W RL 10A-3-3
Rated Thrust:	30,000 lb.
Rated $I_{sp}$ (vac.):	444 sec.
Propellants:	LO <sub>2</sub> /LH <sub>2</sub>
Centaur Jettison:	D-1A: 4,270 lb. D-1T: 4,500 lb.

## STRUCTURE AND PNEUMATICS

The tank structure is made from pressure-stabilized stainless steel, 0.014 thick in the cylindrical section. A double-walled, vacuum-insulated intermediate bulkhead separates the liquid oxygen tank from the liquid hydrogen tank. The aft and intermediate bulkheads form a 1.38:1 ellipsoidal LO<sub>2</sub> tank. The forward bulkhead of the LH<sub>2</sub> tank combines ellipsoidal and conical sections. One-inch-thick fiberglass insulation panels insulate the liquid hydrogen tank section on Centaur D-1A. These are jettisoned during the Atlas sustainer phase. For Centaur D-1T, a 14-foot-diameter aluminum shroud with internal insulations is used in place of the fiberglass panels. Layers of aluminized Mylar radiation shield next to the tank provide insulation in space.

The forward equipment module is a conical aluminum structure attached to the tank by a short

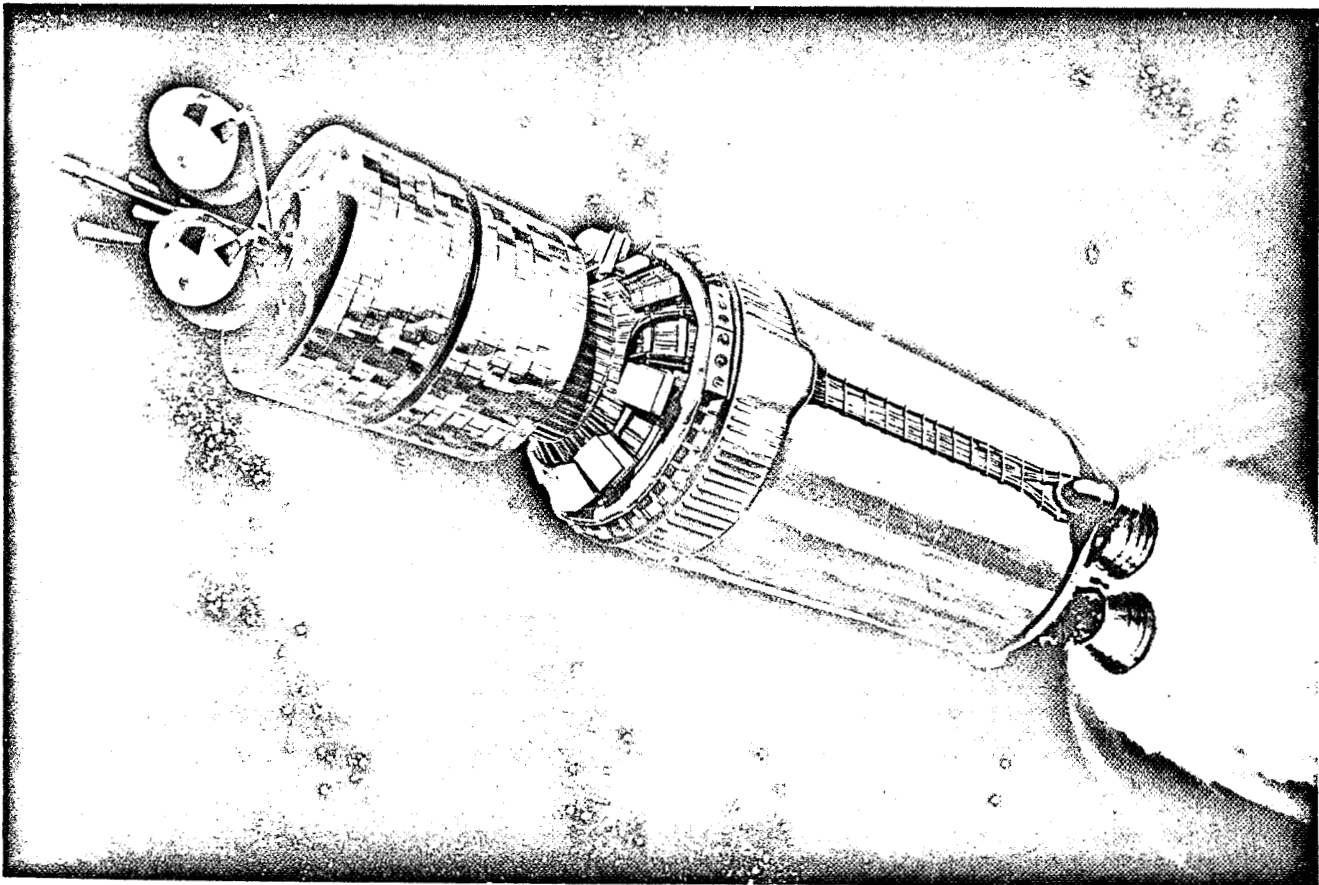

*Centaur D-1A with Intelsat IV Spacecraft*



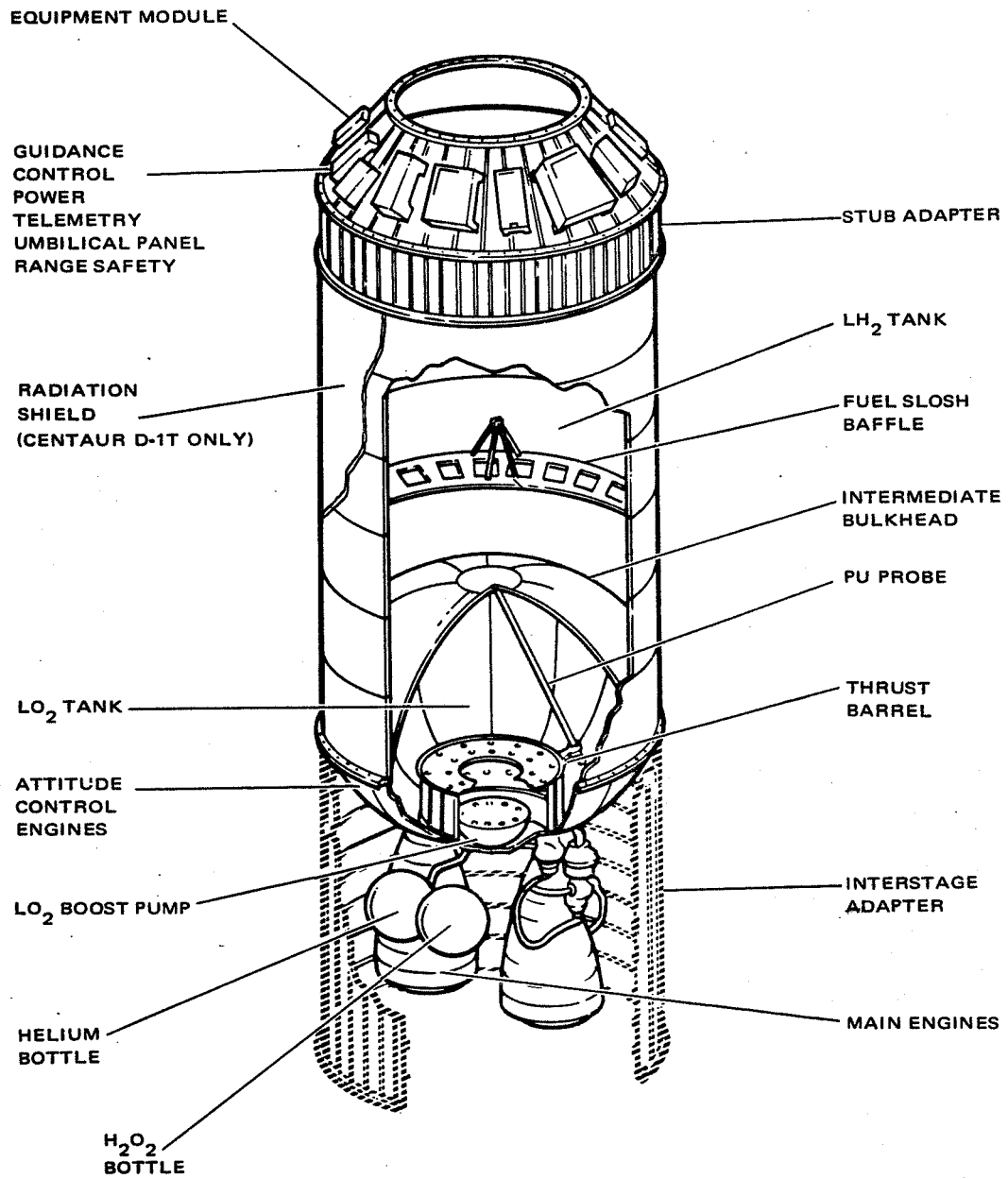

*Centaur D-1*

cylindrical stub adapter. Insulation on the forward bulkhead consists of aluminized Mylar layers, with gaseous helium between the bulkhead and the equipment modules for ground hold and evacuated for long coast conditions.

Two modes of tank pressurization are used. Before tanking, a helium system maintains pressures. With propellants in the tanks, pressure is maintained by propellant boiloff. Nominal LO<sub>2</sub> tank vent valve pressure setting is 30 psia; LH<sub>2</sub> is 21 psia.

### PROPULSION

Primary thrust is provided by two Pratt & Whitney RL10A-3-3 engines developing 30,000 pounds total thrust. These engines are regeneratively cooled and turbopump fed. The propellants are delivered to the main

engine turbopumps by boost pumps. These are driven by turbines fueled by hydrogen peroxide. Main engines are gimbaled by a separate hydraulic system on each main engine.

During coast, separation, and retromaneuvers, attitude control and propellant settling are provided by a hydrogen peroxide system. This system consists of small engines (three to 50 pounds thrust) attached to the aft bulkhead. H<sub>2</sub>O<sub>2</sub> is provided from the same storage sphere to both the boost pumps and the attitude control engines. A 300 psi helium system pressurizes the H<sub>2</sub>O<sub>2</sub> bottle.

A propellant utilization system controls the LO<sub>2</sub> flow rate to ensure that both tanks will be emptied simultaneously. Probes are mounted within the fuel and oxidizer tanks.

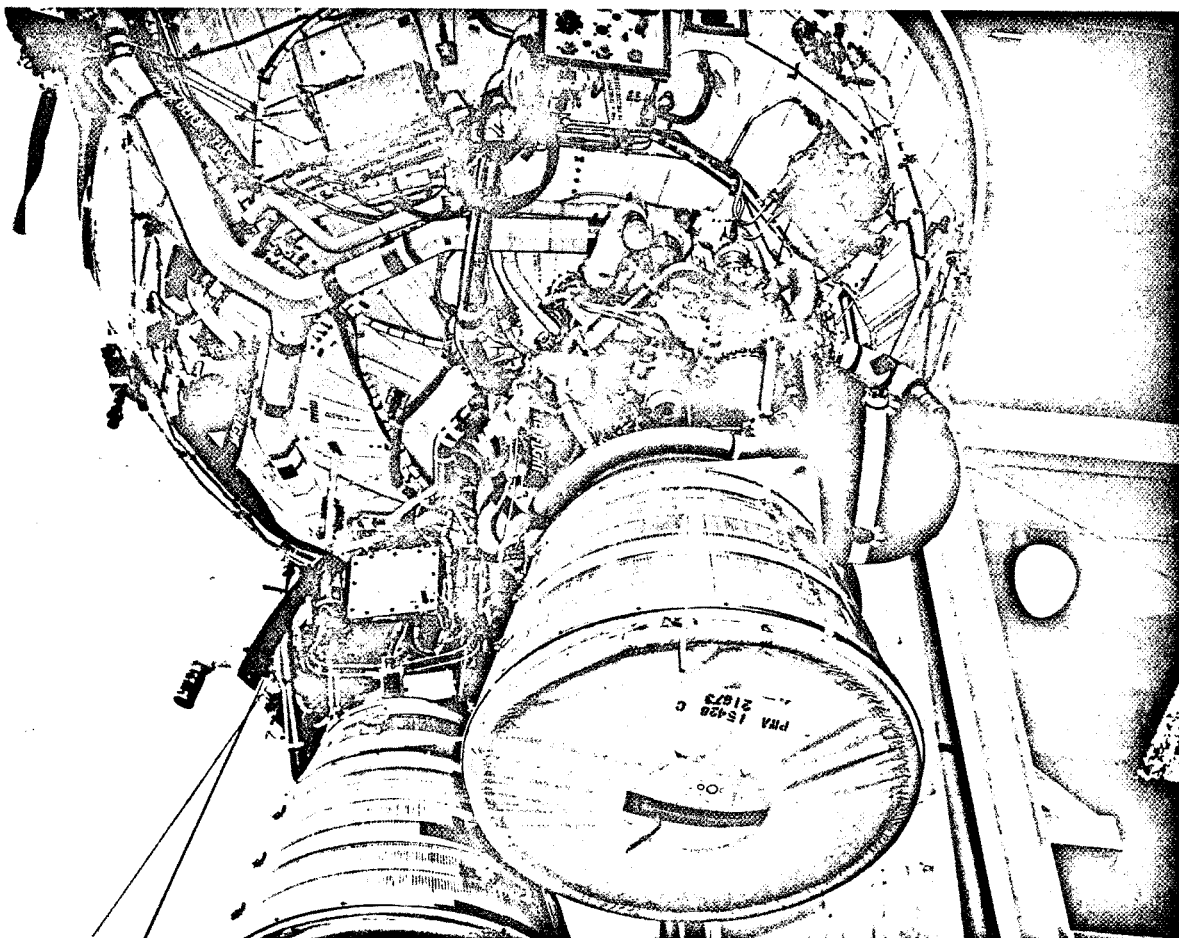

*Centaur Propulsion System*

## ASTRIONICS

The Centaur D-1 astrionics system integrates many former hardware functions into the airborne computer software. Digital autopilot, maneuvering attitude control, sequencing, telemetry formatting, propellant management, plus guidance and navigation are all within the software scope. This results in a flexible system able to readily adapt to mission or vehicle changes. Most of the astrionics components are located in the forward equipment module.

## GUIDANCE AND CONTROL

The Teledyne digital computer unit (DCU) is an advanced, high-speed computer with extensive input and output capabilities. Its fast execution speed and 16,384-word random access memory allow its many functions to be performed with accuracy and with a comfortable margin of memory and duty cycle. From the

DCU, discrettes are provided to the sequence control unit. Engine commands go to the servo inverter unit through six digital-to-analog channels.

The Honeywell inertial reference unit (IRU) contains a four-gimbal, all-attitude stable platform. Three gyros stabilize this platform, on which are mounted three pulse-rebalanced accelerometers. A prism and window allow for optical azimuth alignment. Resolvers on the platform gimbals transform inertial vectors into vehicle coordinates. These vectors originate in the DCU a-c D/A converters. They are frequency multiplexed and outputted to the IRU, which provides the a-c reference voltages for the a-c D/As. A crystal oscillator, which is the primary timing reference, is also contained in the IRU.

The system electronic unit provides conditioned power and sequencing for the IRU. Communication from the IRU to the DCU is through six analog-to-digital channels (for attitude and rate signals) and three

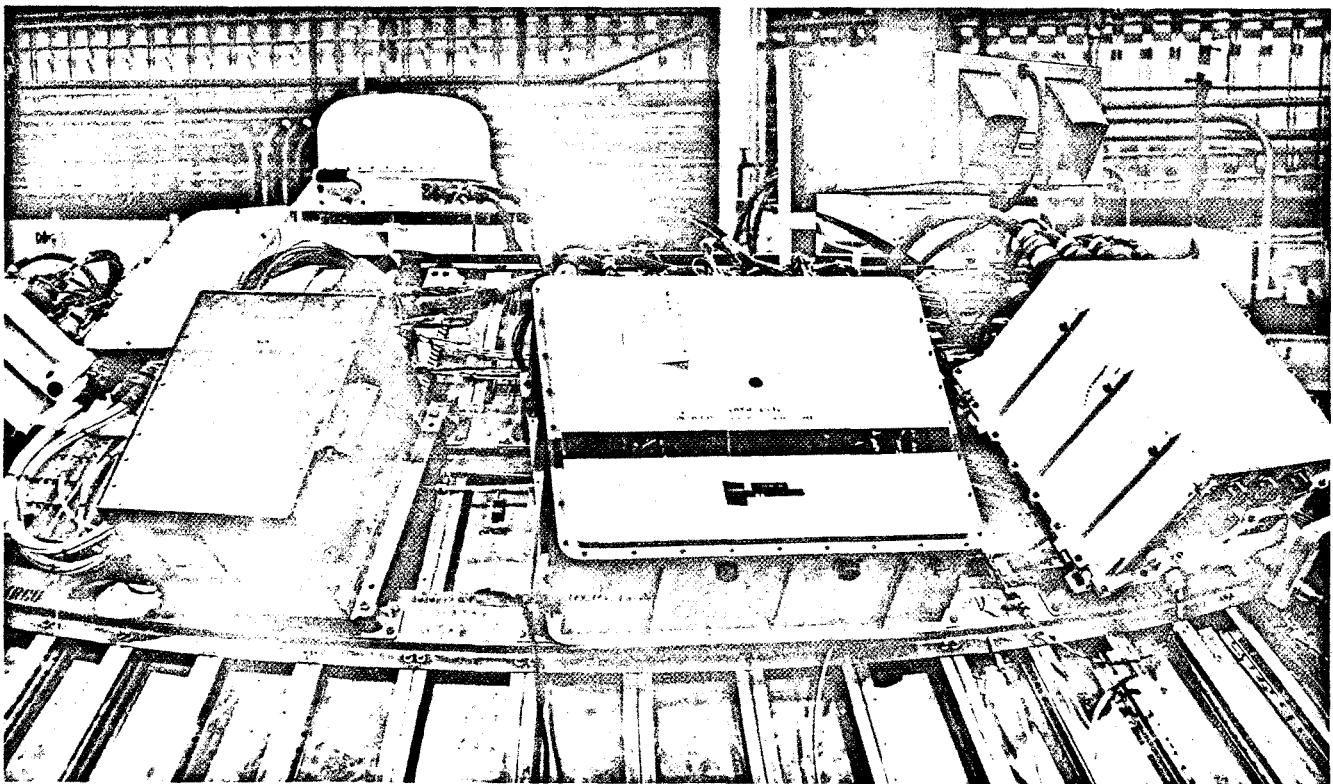

*Centaur Astrionics Mounted to Equipment Module (Test Setup)*

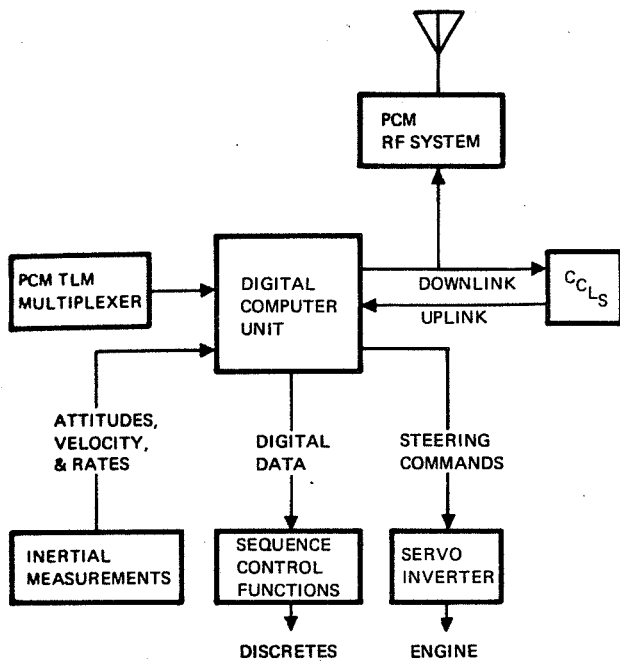

Centaur D-1 Astrionics System

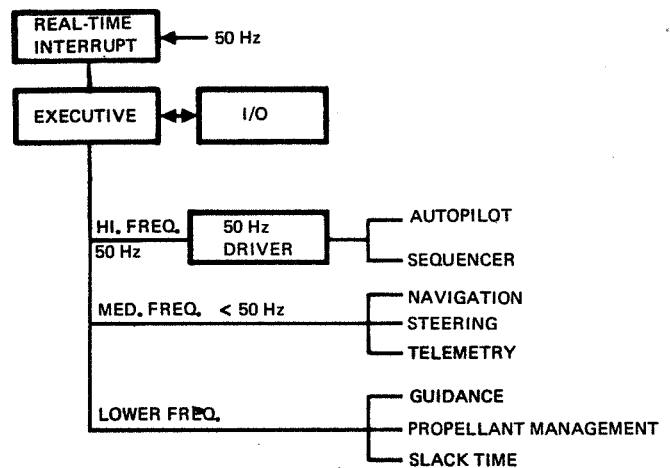

Software Task Organization

incremental velocity channels.

The Centaur D-1A system also provides stabilization and guidance for the Atlas booster. It provides guidance for Titan, with the stabilization function performed by Titan.

### FLIGHT SOFTWARE

The flight software is modularized into several special-purpose subroutines that operate under the control of a real-time executive program. The executive calls subroutines to perform the various tasks, with the software system recognizing hardware interrupts that demand servicing. The system allows interruptable subroutines to be coded separately, with significant advantages in speed and cost of development, modification, and validation.

The flexibility of the flight software allows a variety of mission ascent modes or sequences to be considered for performance or operational improvement. The system philosophy and library of mission and vehicle-peculiar modules allows a high degree of tailoring with a minimum amount of time and cost in programming or validation.

### TELEMETRY

The central controller for the Centaur pulse code modulation (PCM) telemetry system is housed in the same package as the DCU. This arrangement simplifies communications and provides software selectable stored PCM formats. Data from the information sensors is converted to digital words for transmission to the ground station via an S-band transmitter. System capability is 267,000 bits per second, of which about 140,000 are currently used. The central controller can service four Teledyne remote multiplexer units (RMUs). Three are used for Centaur D-1A flights, two for Centaur D-1T flights. (See block diagram on next page.)

### TRACKING

The C-band tracking system provides ground tracking of Centaur during flight. Locations of tracking stations include Cape Kennedy, Grand Bahama, Grand Turk, Antigua, and Bermuda. The airborne transponder returns an amplified radio-frequency signal when it detects a tracking radar's interrogation.

### POWER

Centaur uses a basic d-c power system, provided by batteries and distributed via harnessing. The battery arrangement is flexible, with up to three main batteries

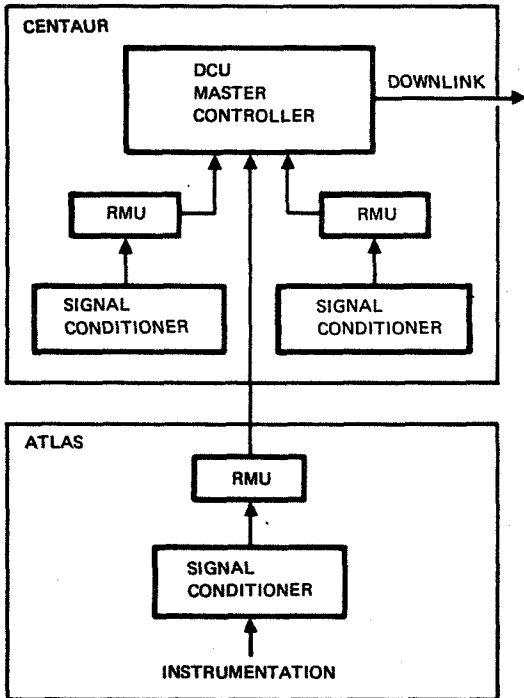

*Centaur D-1A Telemetry*

planned for some missions. If a system requires other than the 28 volts d-c, it internally converts the d-c to whatever its specific power needs are. A-C power, 26 and 115 volts single phase, 400 Hz, is supplied by the servo inverter.

### CHECKOUT SYSTEMS

Among the systems used to check out the Centaur and

confirm its launch readiness are the Computer-Controlled Launch Set (CCLS) and the Flight Acceleration Profile (FAP). CCLS is used to check out the total astronics system at the launch complex or in the factory. FAP provides electronic interfaces and software programs to simulate the DCU flight environment. With this equipment the computer can be effectively flown in the laboratory. These systems provide an intensive, rigorous checkout procedure. Their use of a modern digital computer as the primary checkout tool and of highly developed software allows great flexibility and depth of checkout at reasonable cost.

### COMPUTER-CONTROLLED LAUNCH SET (CCLS)

CCLS functions include calibration and alignment of the inertial measurement group, loading and verification of computer storage and instruction repertoire, testing of the autopilot and propellant utilization airborne electronics, and control of attitude engine commands and RF power. The CCLS ground computer (an XDS-930) is linked to the vehicle via a GSE uplink. Data generated by the airborne equipment is sent back to the ground computer via the PCM system down link.

Software test programs also provide a complete self validation and data processing and compression capability. Examples include programs that operate on the PCM data to do fast Fourier transformations and out-of-tolerance monitoring. Language for most of the software is Fortran.

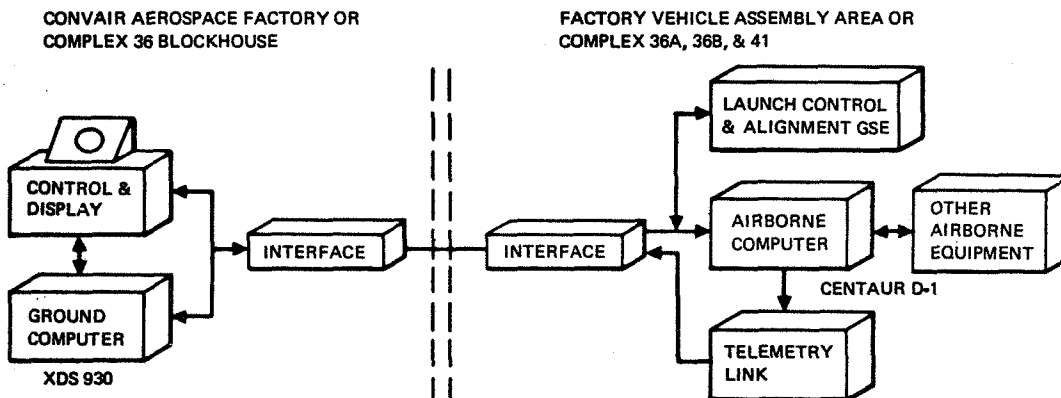

*Computer-Controlled Launch Set*

The CCLS performs tasks best done by computer. These include processing digital data and routine test sequencing, tasks that must be done rigorously and identically every time and for which there is an absolute answer. The operator is still assigned the task of determining the major test sequence and reviewing any hardware or data abnormalities.

The multiprogram software allows up to three test programs and one resident control program to run concurrently in a time-sharing environment. A display system reports up-to-date status to the operator so that he can change the test sequence if necessary without interfering with other tests in progress.

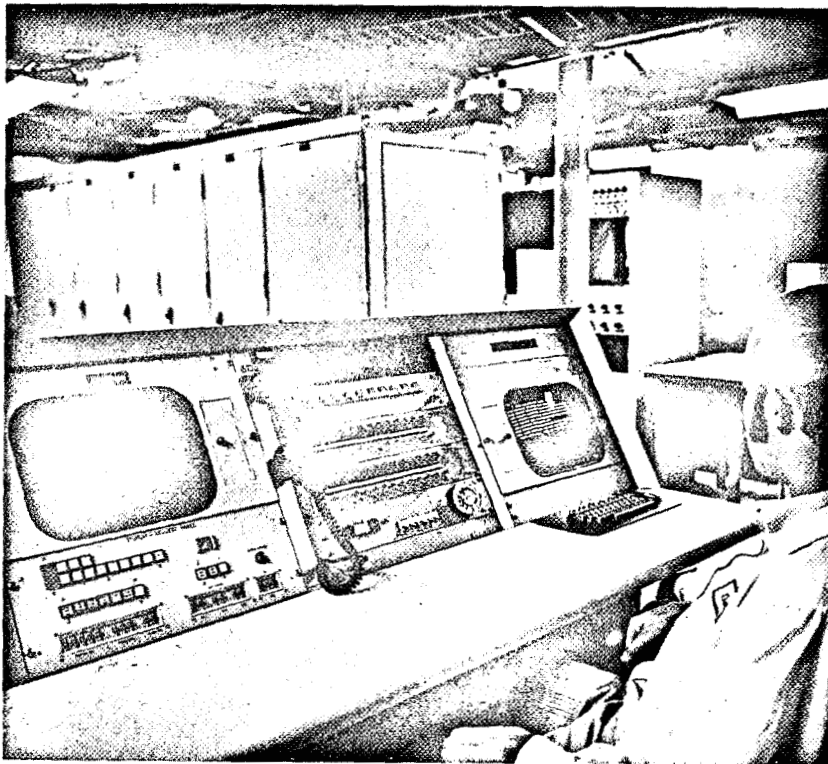

*CCLS Operator's Control and Display Console*

## CENTAUR SYSTEMS VARIATIONS

Two versions of Centaur D-1 exist: D-1A for use with Atlas and D-1T for use with Titan. Differences in the two configurations are shown in the table below.

*Centaur D-1A and D-1T Differences*

ITEM	D-1A	D-1T (TWO-BURN)
STUB ADAPTER	ALUMINUM	TITANIUM WITH ALUMINUM RING
PAYLOAD MOUNTING	5 FT. DIA.	10 FT. DIA. TO TRUSS MOUNTED ON STUB ADAPTER, OR 5 FT. DIA. TO EQUIPMENT MODULE
FAIRING	10 FT. STD. DIA. COVERS PAYLOAD	14 FT. STD. DIA. COVERS CENTAUR & PAYLOAD
TANK INSULATION	JETTISONABLE PANELS	(ASCENT) JETTISONABLE SHROUD WITH INTERNAL INSULATION (SPACE) PERMANENT RADIATION SHIELD
VENTING LH <sub>2</sub>	THROUGH EQUIPMENT MODULE-MOUNTED NOZZLES - NOT AFT-CANTED	THROUGH AFT-CANTED NOZZLES
HELIUM BOTTLES	ONE SMALL (SINGLE BURN) OR ONE LARGE (TWO-BURN)	ONE LARGE
HYDROGEN PEROXIDE REACTION CONTROL	ONE BOTTLE (TWO POSSIBLE) FOUR 50-LB., FOUR 3-LB. THRUSTORS, PLUS TWO CLUSTERS OF ONE 6-LB. & TWO 3.5-LB. THRUSTORS	TWO BOTTLES REMOVE 50-LB. THRUSTORS. CHANGE 3 LB. TO 6 LB.
ELECTRONICS	INTEGRATED WITH ATLAS	TITAN AUTOPILOT SEPARATE
UMBILICALS	FOR COMPLEX 36	FOR COMPLEX 41
BATTERIES	CHOICE OF 100 OR 150 AMP-HR.	150 AMP-HR.

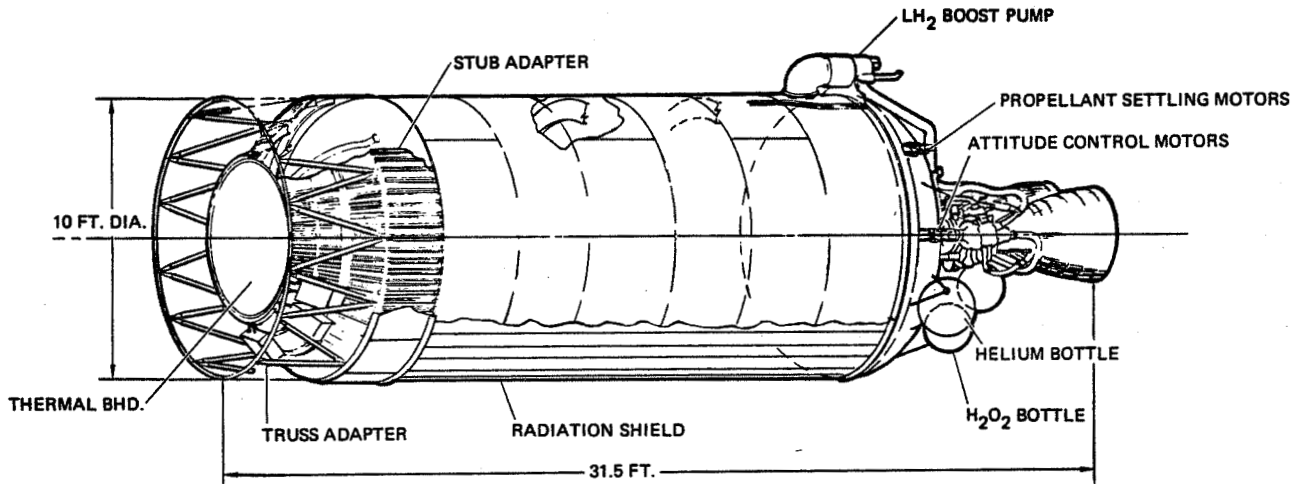

*Centaur D-1T*

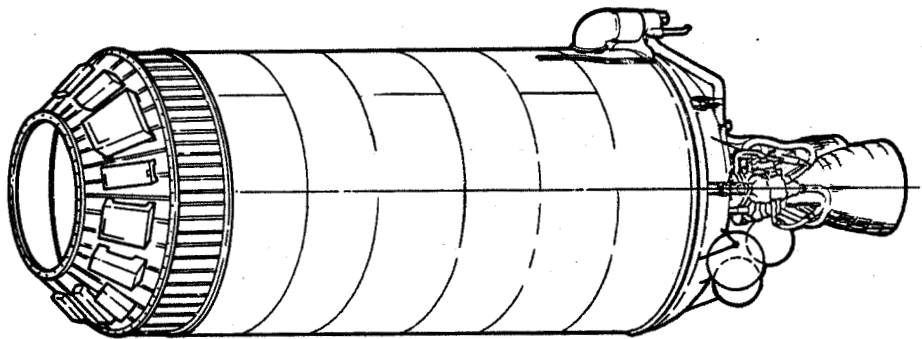

*Centaur D-1A*

Some changes are made to the standard two-burn Centaur D-1T to provide three-burn capability. The major changes are shown below.

ITEM	FOR CENTAUR D-1T THREE-BURN
BATTERIES	ADD TWO (150 AMP HOURS EACH)
PNEUMATIC SYSTEM	ADD ONE GHe BOTTLE & SECOND PRESSURE VALVE
VENT SYSTEM	MODIFY VENT VALVES FOR THERMAL CONTROL
ANTENNAS	ADD TWO S-BAND DIRECTIONAL ANTENNAS
INSULATION	ADD RADIATION SHIELDING ON VARIOUS COMPONENTS
SLOSH BAFFLE	ADD SECOND BAFFLE
SOFTWARE	PROVIDE ROLL CONTROL & FOR THERMAL CONTROL, ROLL VEHICLE 180 DEGREES EVERY HALF HOUR DURING TRANSFER COAST





ATLAS/CENTAUR

## **ATLAS/CENTAUR**

<b>SUMMARY</b>	<b>3-3</b>
<b>DESCRIPTION</b>	<b>3-4</b>
<b>PERFORMANCE</b>	<b>3-5</b>
<b>FLIGHT PROFILE</b>	<b>3-6</b>
<b>ACCURACY</b>	<b>3-11</b>
<b>FAIRING AND ENVELOPE</b>	<b>3-13</b>
<b>INTERFACES</b>	<b>3-15</b>
<b>ENVIRONMENT</b>	<b>3-18</b>
<b>LAUNCH FACILITIES</b>	<b>3-21</b>
<b>PROCUREMENT AND MAINTENANCE</b>	<b>3-24</b>

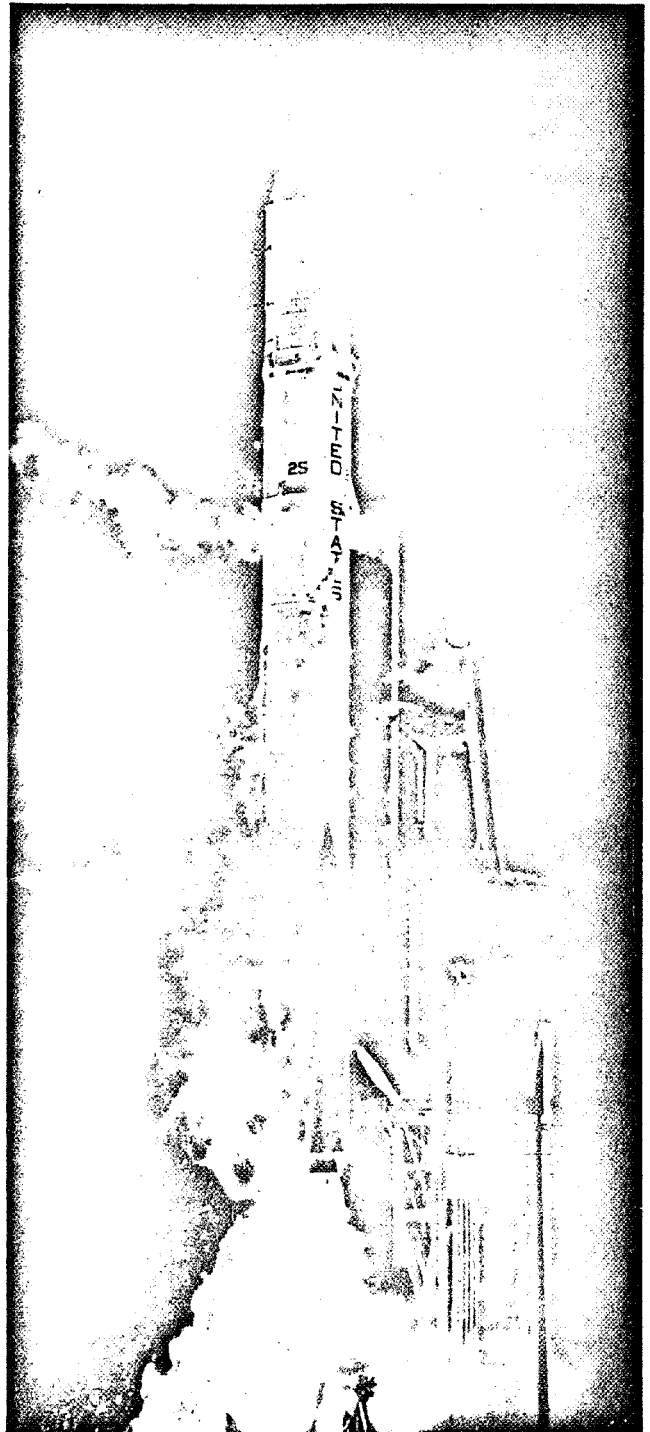
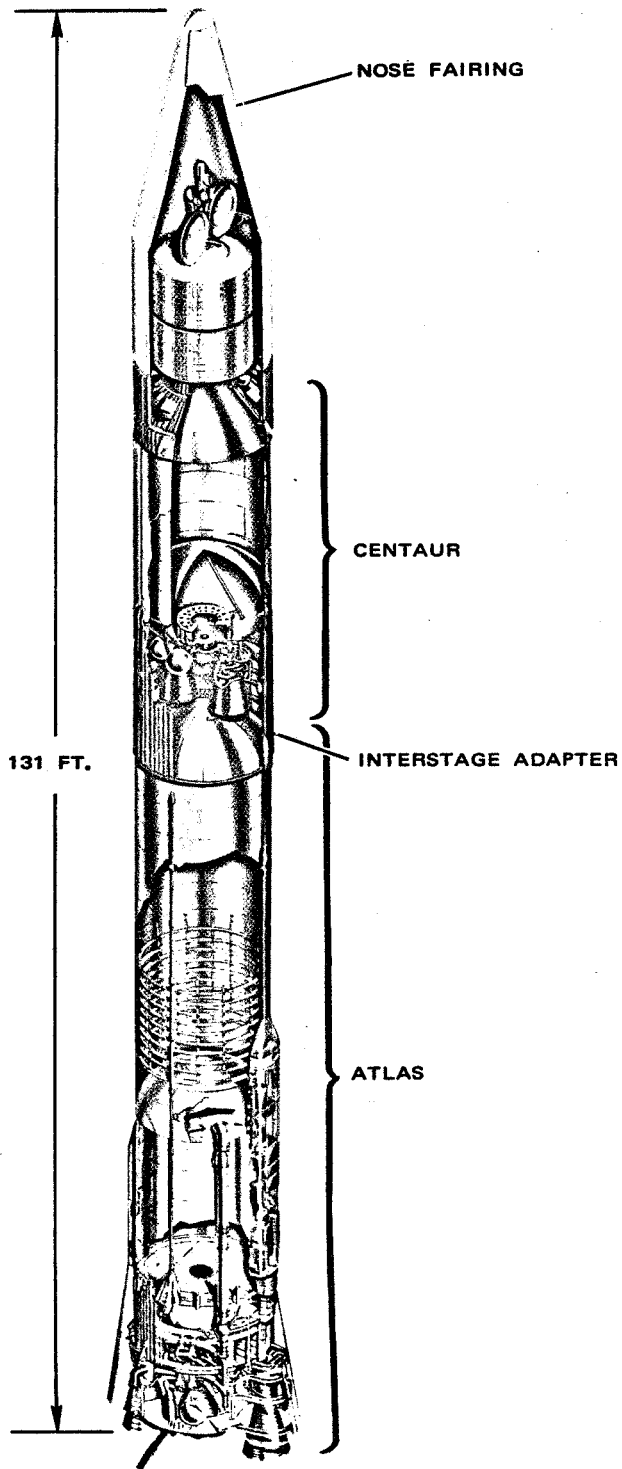

## ATLAS/CENTAUR D-1A SUMMARY

**BOOSTER:** ATLAS SLV-3D

**UPPER STAGE:** CENTAUR D-1A

**STATUS (JUNE 1971):** SLV-3C/CENTAUR D CURRENTLY OPERATIONAL  
SLV-3D/CENTAUR D-1A OPERATIONAL IN LATE 1972

**FLIGHT HISTORY (TO 30 JUNE 1971)** 24 ATLAS/CENTAUR FLIGHTS, 16 OPERATIONAL

**SCHEDULE:** FIRM LAUNCHES THROUGH EARLY 1974, INCLUDING  
INTELSAT IV, PIONEER G, & MARINER VENUS/  
MERCURY '73

**PERFORMANCE CAPABILITY:** LAUNCH FROM EASTERN TEST RANGE  
100 N.MI. CIRCULAR: 11,200 LB.  
SYNCHRONOUS TRANSFER: 4,100 LB.  
ESCAPE:  
C<sub>3</sub> = 0 km<sup>2</sup>/sec.<sup>2</sup>: 2,650 LB.  
C<sub>3</sub> = 20 km<sup>2</sup>/sec.<sup>2</sup>: 1,300 LB.

**PROCUREMENT LEAD TIME:  
(ROUTINE)** ATLAS SLV-3D: 18 MONTHS TO DD250  
CENTAUR D-1A:  
23 MONTHS TO DD250  
26 MONTHS TO LAUNCH

**LAUNCH SITE:** EASTERN TEST RANGE LAUNCH  
COMPLEX 36A & 36B

## LAUNCH VEHICLE DESCRIPTION

### ATLAS SLV-3D/CENTAUR D-1A

Centaur was initially designed as the high-energy upper stage for the Atlas space booster. This combination has been operational since 1966 and has flown all Centaur missions to date.

### ATLAS SLV-3D

The liftoff thrust (431,040 pounds) is indicative of the many improvements that have made the SLV-3D the advanced booster it is today. Atlas was originally developed as a U.S. Air Force weapon system with a total

thrust of 359,000 pounds. Early in its development period, Atlas made the transition to become a versatile and highly reliable space booster. It has since undergone a series of improvements, including tank lengthening, engine performance increases, and system updating.

Atlas has a constant ten-foot-diameter tank up to the attach point of the interstage adapter. Total length from adapter rearward is 72 feet. Equipment is mounted within a pod on the side. A helium pressure system maintains structural integrity and turbopump pressure head during flight.

All Atlas engines of the Rocketdyne MA-5 propulsion system are ignited prior to liftoff. The two booster engines and the single sustainer engine share the same propellant tank. The booster engines are jettisoned about two and a half minutes into flight at about 5.7g acceleration. The sustainer burns until propellant depletion. Two small vernier rockets assist in the early roll maneuver to the desired azimuth and provide roll control

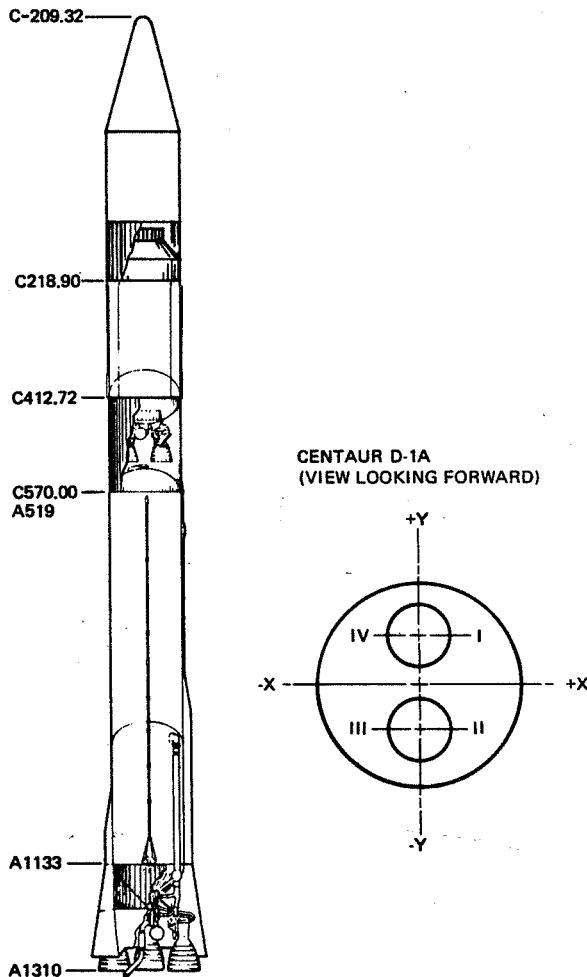

Reference Stations, Axes, and Quadrants

### ENGINE SUMMARY

#### Rated Sea Level Thrust (lb.):

Booster:	370,000
Sustainer:	60,000
Vernier:	1,040 axial
<b>Total:</b>	<b>431,040</b>

#### Rated I<sub>sp</sub>, Sea Level/Vacuum:

Booster:	257/292 sec.
Sustainer:	221/312 sec.

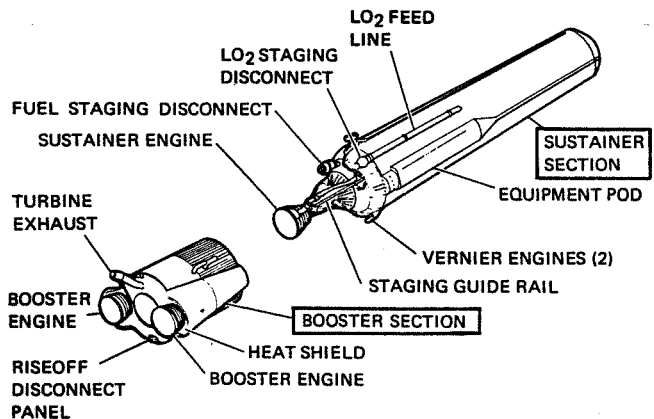

Atlas Configuration

during sustainer phase. Propellants for all engines are LO<sub>2</sub> and RP-1.

Attitude control is maintained by gimbaling the vernier and main engines, under the direction of the digital autopilot and guidance equations in the Centaur digital computer unit. The sustainer engine gimbals during the sustainer phase only. Open loop pitch and yaw programs are selectable based on the launch-day winds.

The aluminum interstage adapter remains attached to Atlas after separation. Atlas is moved away from Centaur by firing eight solid-propellant retrorockets. These are mounted around the aft end of the Atlas tank.

### PERFORMANCE

The Centaur upper stage is a versatile vehicle with proven flight experience in virtually all mission modes. A few of

#### LOW EARTH ORBIT

Mode: Direct ascent or Hohmann transfer

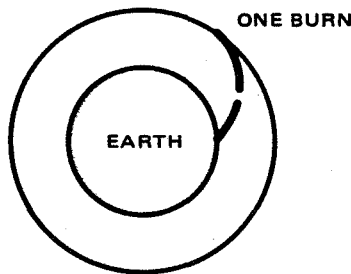

Direct Ascent

#### SYNCHRONOUS

Mode: Hohmann transfer with apogee kick by spacecraft, TE-364, or Burner II

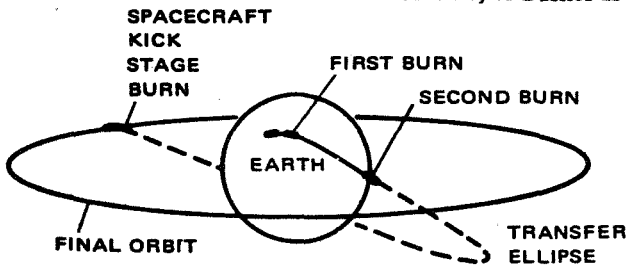

Synchronous Equatorial Orbit

the mission applications typical of Centaur's flexibility are shown in the adjoining illustrations.

#### ESCAPE

Mode: Direct ascent or parking orbit, with TE-364 optional

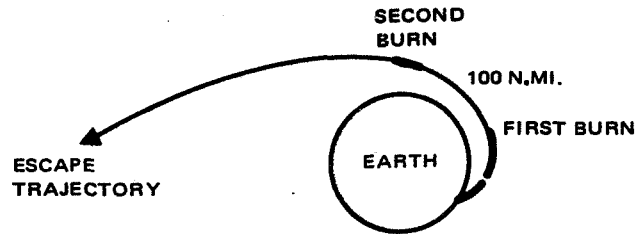

Parking Orbit Coast Mode

#### PERFORMANCE GROUND RULES

Atlas/Centaur performance determination is based on:

Launch Site:	ETR Pad 36B
Launch Azimuth:	90 deg.
Parking Orbit:	100 n.mi. circular
Nose Fairing:	2,958 lb.
Propulsion:	
Atlas:	See page 3-4
Centaur:	See page 2-1

#### GENERALIZED PAYLOAD CAPABILITY

Payload capability of the Atlas/Centaur for a range of characteristic mission velocities for an ETR launch is shown in the accompanying illustration. The capabilities are given for the standard Atlas SLV-3D and for a growth version under consideration that has a tank length stretched by 80 inches (see page 6-3). All payload capabilities account for the Centaur flight performance reserve, including allowance for three-sigma flight conditions.

# ATLAS/CENTAUR FLIGHT PROFILE

Trajectory data and sequences of events differ widely for the variety of missions flown by Atlas/Centaur D-1A. Spacecraft weights, direct ascent or parking orbit, mission or tracking requirements, and constraints all lead to a trajectory and sequence tailored to the specific mission needs.

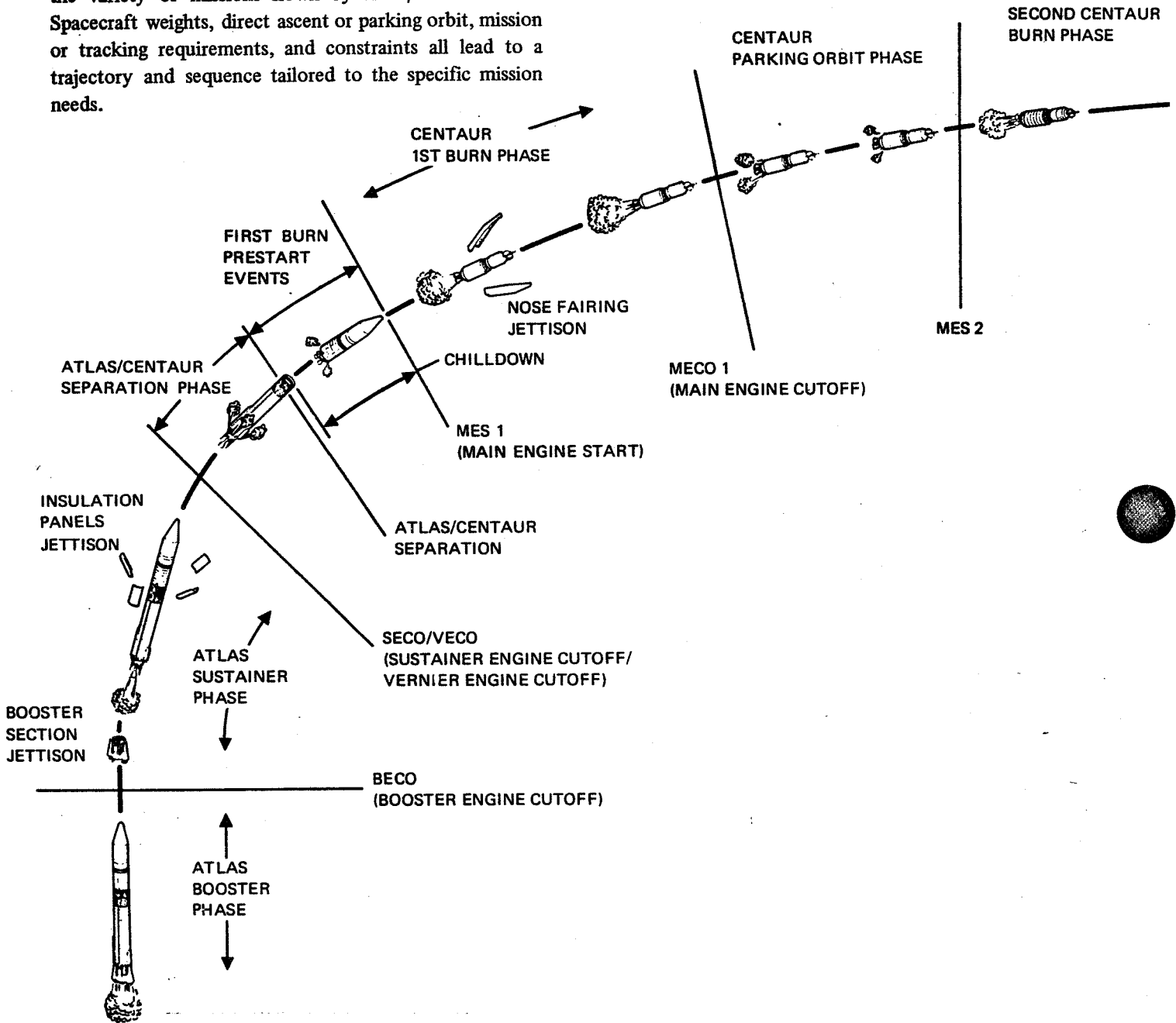

*Atlas/Centaur Parking Orbit Mission Delivering a Spacecraft to Synchronous Apogee Transfer*

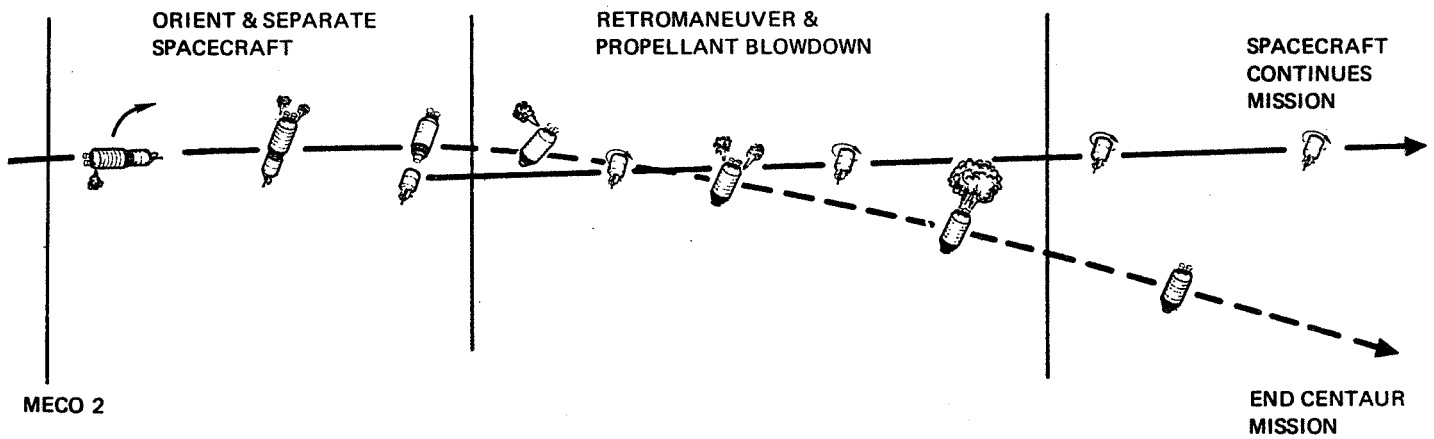

*Preliminary Atlas/Centaur D-1A Sequence of Events*

EVENT	BASIS	APPROX. TIME FROM LIFTOFF (SEC.)
LIFTOFF	2-IN. MOTION	0
ROLL PROGRAM	LIFTOFF + 2 SEC.	2-15
BECO	5.7g	153
BOOSTER PACKAGE JETTISON	BECO + 3.1 SEC.	156
JETTISON INSULATION PANELS	BECO + 45 SEC.	201
SECO	PROP. DEPLETION	251
SEPARATION	SECO + 1.9 SEC.	253
MES 1	SECO + 11.5 SEC.	263
JETTISON NOSE FAIRING	MES 1 + 12 SEC.	275
MECO 1	PARKING ORBIT (GUID.)	586
MES 2	GUIDANCE	2,086
MECO 2	HOHMANN APOGEE	2,200
SEPARATION	MECO 2 + $\Delta t$ (VARIES)	



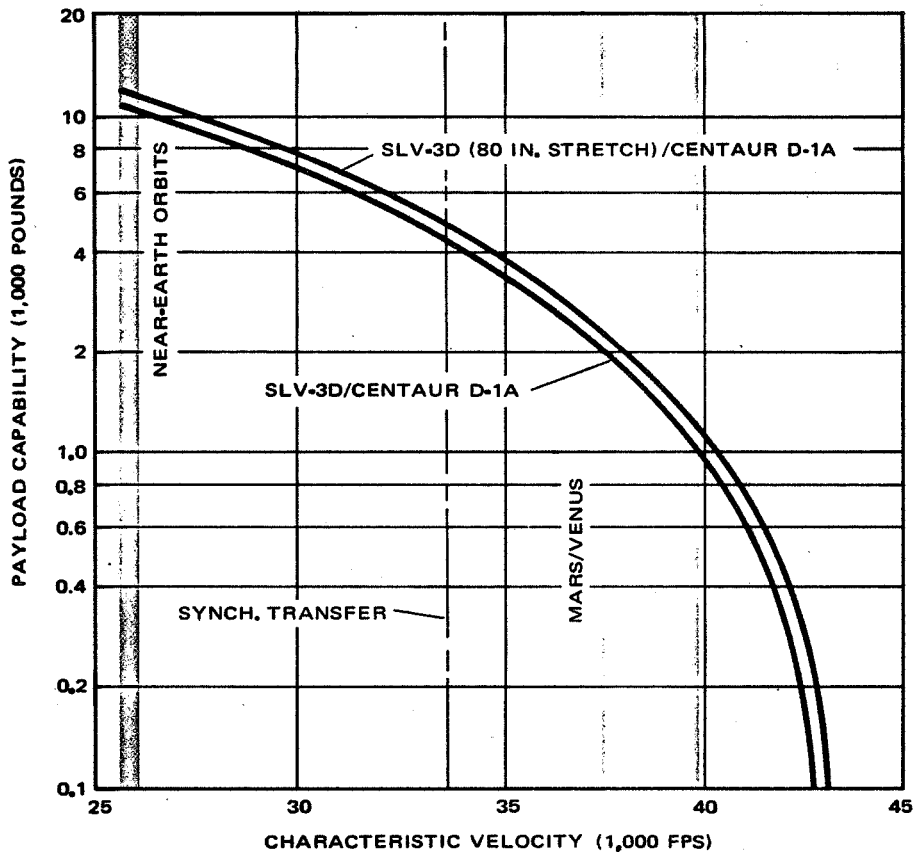

Generalized Payload Capability

**CIRCULAR ORBIT CAPABILITY**

Circular orbit payload capability of the Atlas/Centaur is illustrated for one- and two-burn Centaur injection modes. Payload losses for added batteries, attitude control, or propellant losses incurred during long Hohmann coast trajectories are accounted for.

**SYNCHRONOUS TRANSFER ORBIT PAYLOAD CAPABILITY**

The payload capability for the synchronous transfer orbit (100 x 19,300 n.mi.) as a function of perigee plane change is shown. For this mission, the Centaur second burn occurs at the first nodal equatorial crossing. For missions requiring the second burn to occur at the second nodal crossing, additional peroxide must be carried for the longer coast, resulting in a 60-pound payload loss. Zero perigee plane change conforms to a synchronous transfer orbit inclination of 28.3 degrees (90-degree launch azimuth).

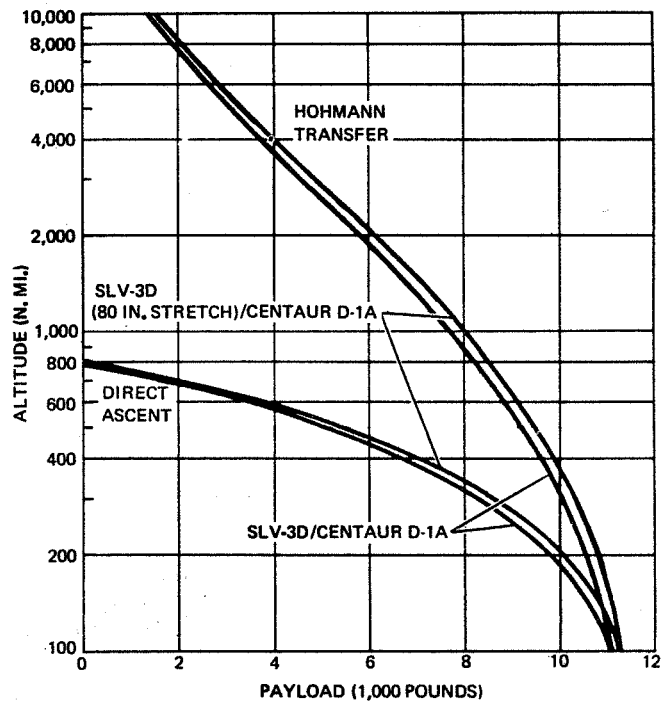

Circular Orbit Payload Capability

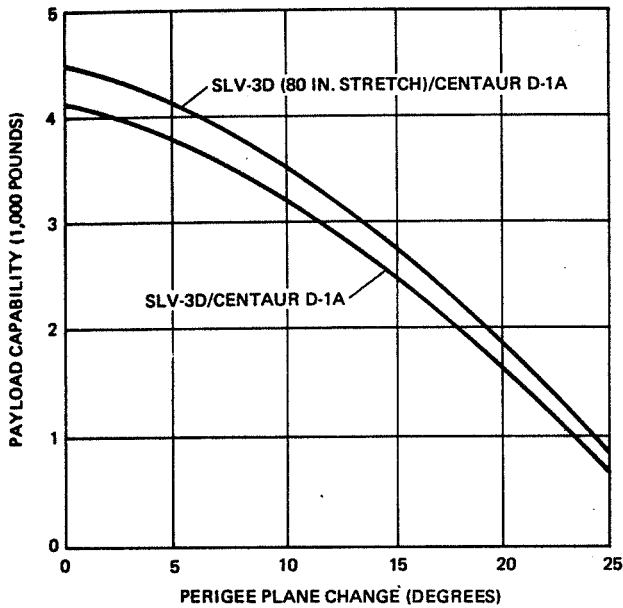

*Synchronous Transfer Orbit Payload Capability*

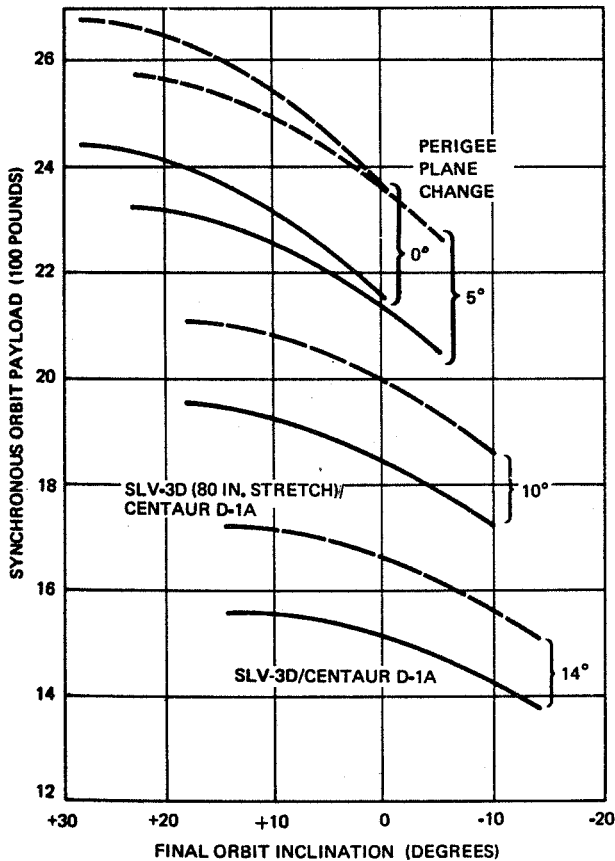

*Synchronous Circular Orbit Payload Capability*

### SYNCHRONOUS CIRCULAR ORBIT PAYLOAD CAPABILITY

Presented is the synchronous circular orbit payload capability for various final orbit inclinations. An apogee kick motor (AKM) is assumed. To obtain usable payload capability from spacecraft burnout weight, the spacecraft truss and AKM case weights must be subtracted. The case weight for a TE-364-4 solid motor is 172 pounds. The required AKM propellant weight is also shown.

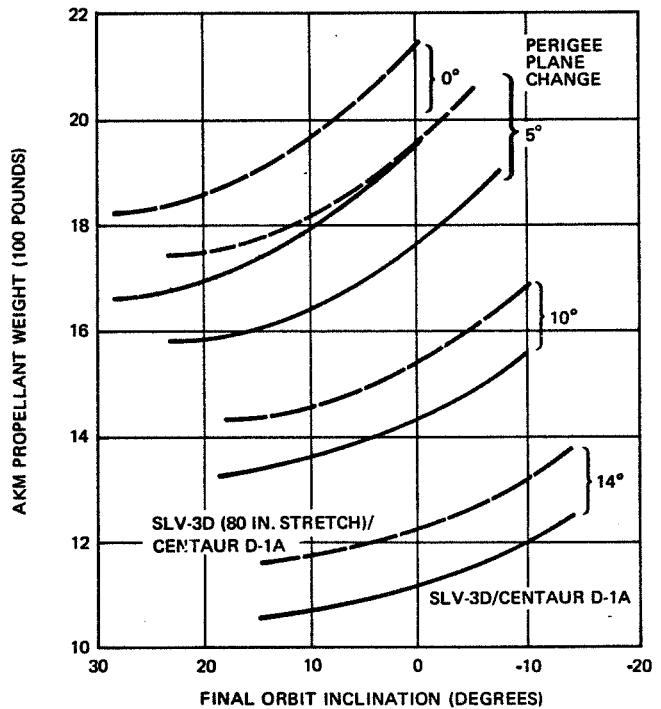

*AKM Propellant Weights for Synchronous Altitude*

### PLANETARY OR ESCAPE PAYLOAD CAPABILITY

Payload capability shown is for parking orbit ascent, 20-minute coast, with and without a solid spin-stabilized kick motor.

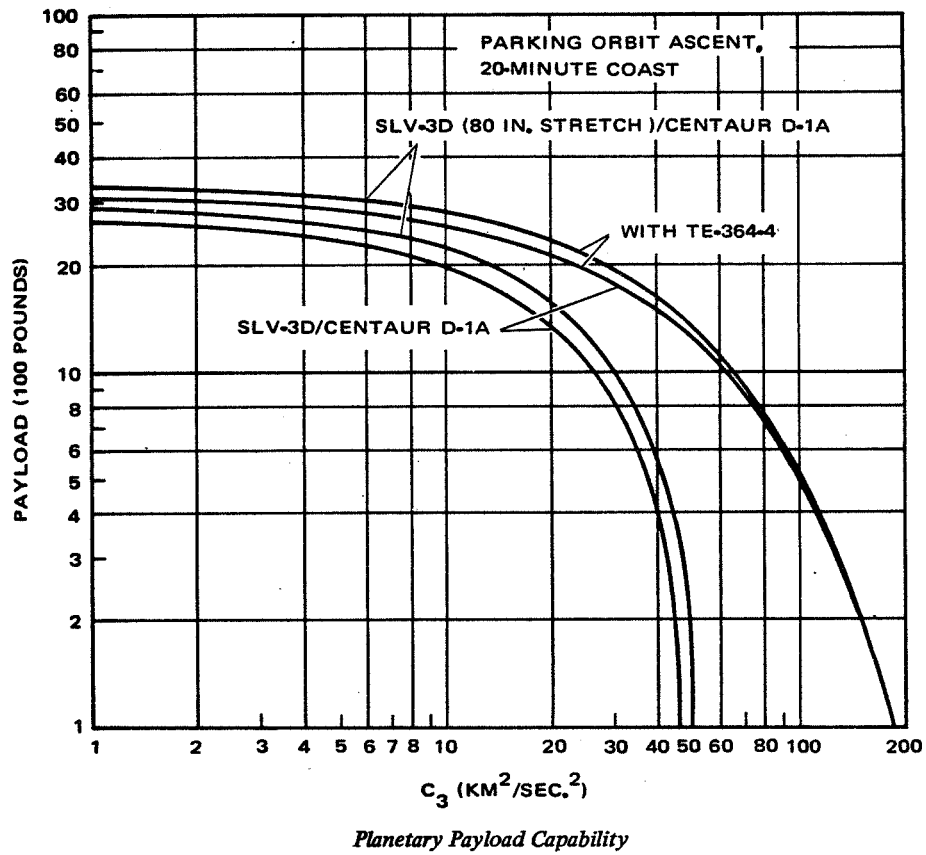

## ACCURACY

With its precision inertial guidance system, Centaur is a highly accurate upper stage. An example was the launch of the first Intelsat IV by Atlas/Centaur in January 1971. Accuracy of the transfer ellipse was near perfect, with a synchronous apogee error of only six miles.

Other demonstrations were provided by the Mariner Mars '69 launches. Aiming at a target over 200 million miles distant, Centaur placed the first spacecraft within 3,100 miles of its target (pre-midcourse correction). For a trip requiring nearly half a year, Mariner would arrive within 73 minutes of its planned time. The small magnitude of these efforts nearly eliminated the need for a near-earth spacecraft midcourse correction maneuver.

The guidance system for Centaur D-1 will provide comparable accuracy to Centaur D with greater flexibility due to the new computer and software.

Here are examples of Centaur accuracy in several types of missions:

Mission: Near-earth orbit  
Mode: Direct ascent

MISSION REQUIREMENT		FLIGHT DATA (OAO)	ACCURACY ANALYSIS $\pm 1\sigma$
INJECTION ALTITUDE (N.MI.)	1.7	0.05	0.27
APOGEE MINUS PERIGEE (N.MI.)	5	1.01	1.8
INCLINATION (DEG.)	0.33	0.017	0.012

NOTE: DATA IS SHOWN FOR AN OAO TRAJECTORY, WITH 417 N.MI. ALTITUDE CIRCULAR ORBIT & 35-DEGREE INCLINATION

*Nearly Perfect Aim at a Target 200 Million Miles Distant (Mariner '69)*

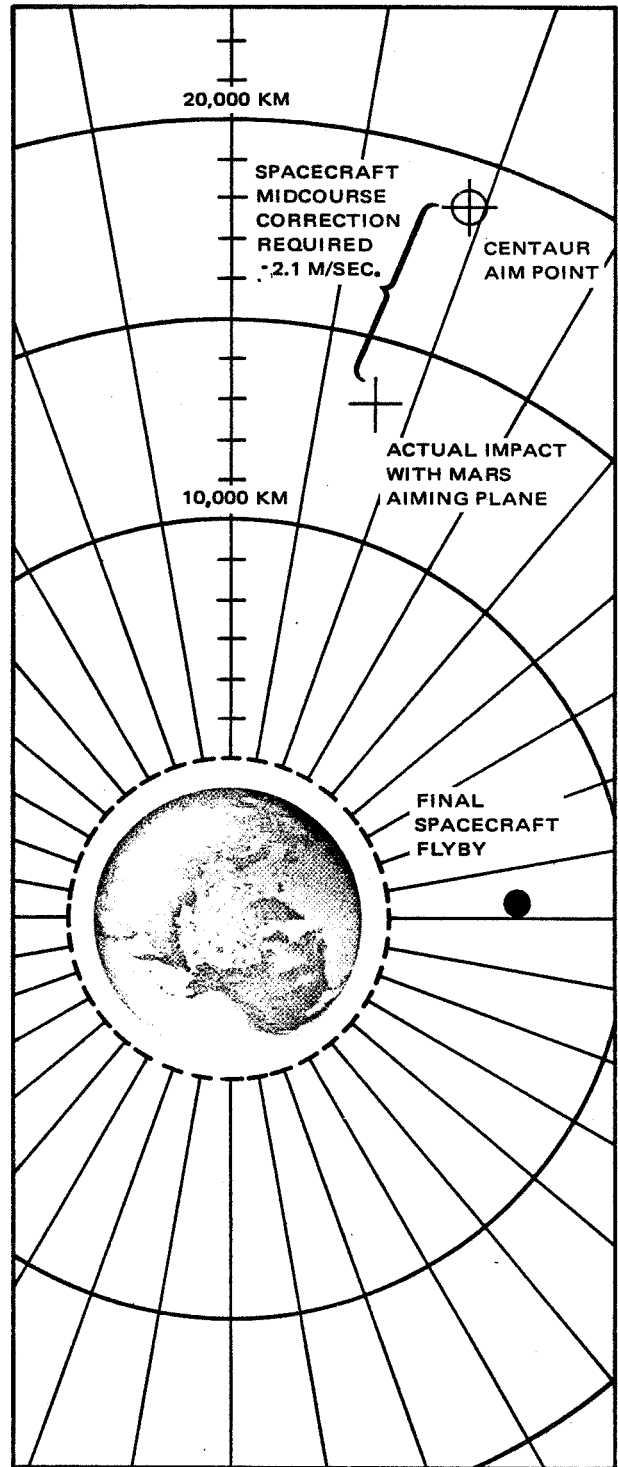

Mission: Synchronous orbit  
 Mode: Parking orbit (second Centaur burn at first equatorial crossing)

	TRANSFER ORBIT		FINAL SYNCHRONOUS EQUATORIAL ORBIT	
	FLIGHT DATA INTELSAT IV	ACCURACY ANALYSIS $\pm 1\sigma$	ACCURACY ANALYSIS $\pm 1\sigma$	
			SOLID AKM	CENTAUR 3RD BURN
PERIGEE (N.MI.)	0.01	0.55	-	-
APOGEE (N.MI.)	6.1	26	-	-
APOGEE MINUS PERIGEE (N.MI.)			109	120
INCLINATION (DEG.)	0.032	0.013	0.12	0.11
PERIOD (MIN.)	0.16	0.93	5.9	4.5

Mission: Planetary  
 Mode: Direct ascent or parking orbit

	MARS			JUPITER
	MISSION REQUIREMENT*	FLIGHT DATA*	ACCURACY ANALYSIS**	ACCURACY ANALYSIS***
SC 10TH DAY MIDCOURSE CORRECTION REQUIRED (M/SEC.)	4.5	2.2/2.0 MARINER '71 1.1	3.3	30
UNCORRECTED TARGET MISS (KM)		5,368/ 12,750	50,000	

- \* FLIGHT DATA FROM MARINER MARS '69
- \*\* ACCURACY ANALYSIS FOR MARINER MARS '71. ACCURACY DATA IS HEAVILY DEPENDENT ON ASCENT MODE, LAUNCH DAY, AND TIME IN LAUNCH WINDOW. VALUES SHOWN ARE THE LARGEST FOR TRAJECTORIES OF THIS MISSION
- \*\*\* DATA IS FOR PIONEER F&G AND INCLUDES THE ERROR DUE TO TE-364-4, WHICH CONTRIBUTES MOST OF THE ERROR

### POINTING ACCURACY

Immediately after the final Centaur burn, the Centaur typically begins aligning its longitudinal axis to the direction in which the spacecraft wishes to be pointed at separation. At the conclusion of this maneuver (180 degrees or less), the spacecraft is separated.

When sufficient separation between the spacecraft and the Centaur vehicle exists, the Centaur can be reoriented to any attitude for propellant residuals blowdown. Cone angle pointing accuracy and attitude residual rates are shown in the table at right.

CONE ANGLE	DEG.	FLIGHT DATA*	ACCURACY ANALYSIS $\pm 3\sigma$
		0.1	1.2
RESIDUAL RATE PITCH & YAW	DEG./SEC.		0.1

\*ESTIMATED BY COMSAT FOR INTELSAT IV, AFTER SEPARATION & SPACECRAFT SPINUP

## ATLAS/CENTAUR STANDARD FAIRING

### SPACECRAFT ENVELOPE

The spacecraft envelope is shown below with the Intelsat IV spacecraft adapter. The adapter is mission peculiar, with the actual envelope length varying for each adapter. Total envelope length with this adapter is about 301 inches.

The envelope shown is for the maximum permissible dimensions of the payload. Manufacturing tolerances and dynamic motion of the fairing have been accounted for in arriving at this envelope. A minimum radial clearance of approximately one inch will exist between the envelope and fairing in its maximum configuration during ascent and fairing jettison. The spacecraft must be smaller than this envelope by the amount of its dynamic motion plus buildup tolerances.

### FAIRING DESCRIPTION

The Centaur D-1A standard fairing attaches to the stub adapter and protects the spacecraft during the ascent phase of the trajectory. The D-1A fairing is an improved version of that flown on OAO and Intelsat IV missions. Its total length is 33.6 feet and diameter in the cylindrical section is ten feet.

Two structures comprise the total fairing – the forward conical/cylindrical section and the aft cylindrical split barrel section. Each section splits longitudinally in half during the process of jettisoning shortly after Centaur's first main engine start.

The forward section is 29 feet long. It is made from fiberglass honeycomb, which provides structural integrity, thermal insulation, and RF transparency. This section is capped with a spherical laminate of phenolic and high silicone fiberglass 0.31 inch thick. Conical and cylindrical segments are 1.82 inches thick.

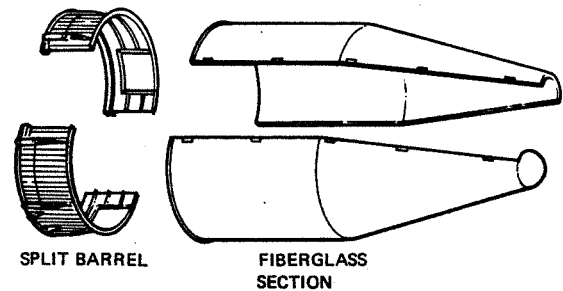

*Centaur D-1A Standard Fairing*

The 56-inch-long split barrel bolts to the forward section. It is constructed of aluminum skin and longitudinal stringers.

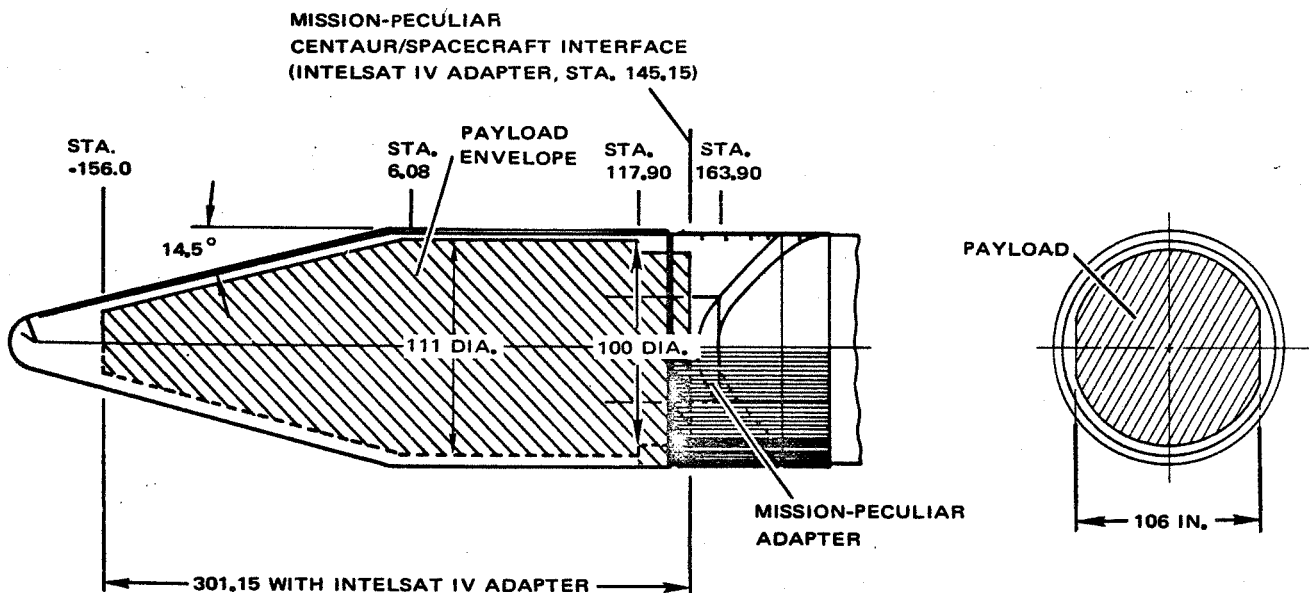

*Spacecraft Envelope for Centaur D-1A*

The split barrel section has four access doors for use during the payload and fairing mounting process and during Centaur equipment checkout. It also has a cutout for the Centaur forward umbilical disconnect panel and provisions for air-conditioning ducting and LH<sub>2</sub> venting.

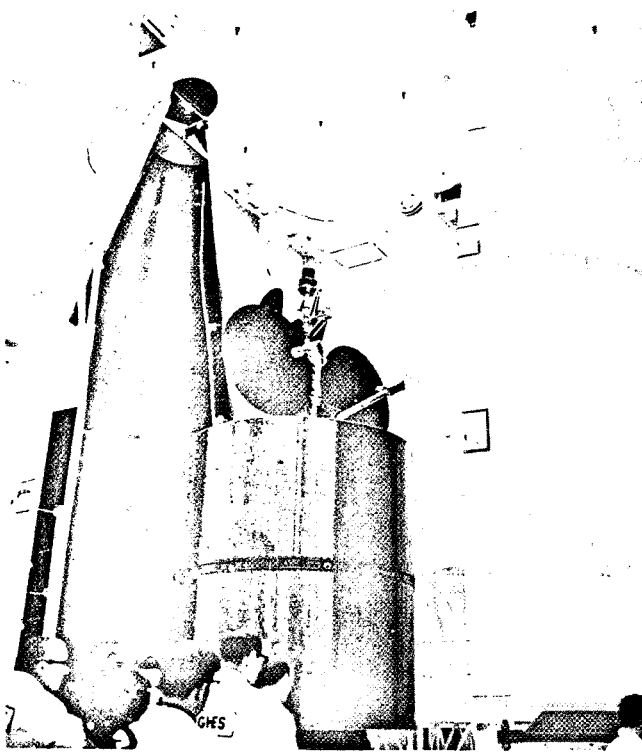

*Current Centaur Fairing (for Intelsat IV)*

### FAIRING GROWTH POTENTIAL

The standard fairing can be readily tailored to suit payload requirements for launches from Complex 36B. An additional 5 feet more payload length, 111 inches in diameter, can be accommodated with no modification other than inserting an additional barrel section between the standard sections. This provides a payload envelope length of about 30 feet. Additional lengthening is feasible, though new springs would be required and added ground jettison tests would be desirable.

Performance loss from increasing the fairing length depends on the mission orbit and mission or vehicle

constraints. In general, for a synchronous transfer mission, the payload capability is reduced about 11 pounds per fairing foot.

For smaller payloads and to gain performance, the fairing can also be shortened. This is done by reducing the length of the cylindrical fiberglass section. Payload to synchronous apogee increases by about 10.3 pounds per fairing foot.

### FAIRING JETTISON

The two fairing halves are held together by a dozen explosive bolts mounted along the vertical split line. Another eight explosive bolts attach the fairing to the stub adapter. Separation force is provided by two springs, held compressed by the shroud halves and located at the forward end of the fairing.

Fairing jettison is initiated by a discrete from the Centaur digital computer unit. At jettison the explosive bolts fire, releasing the two fairing halves. The springs separate the two halves, which rotate about the four hinges attached to the stub adapter.

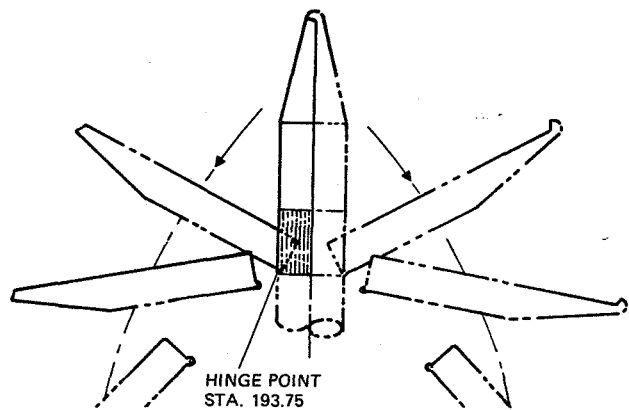

*Fairing Jettison*

The separation bolts are pyrotechnically and mechanically redundant, explosive pressure cartridge-actuated bolts. They are noncontaminating and allow no debris to enter the spacecraft area. Damage or contamination of the spacecraft due to the springs is prevented by enclosing the springs in telescoping aluminum cylinders.

## ENVIRONMENTAL CONTROLS

At Complex 36, filtered, conditioned air or GN<sub>2</sub> is provided to the spacecraft from the umbilical tower. The inlet door on the shroud is about 20 inches above the split barrel. The ground duct is held to the airborne disconnect by an inflatable seal. The duct is released at liftoff by a reduction in pressure in the seal. The umbilical boom retracts the line as the vehicle lifts off the pad. As the ground duct withdraws, a spring-loaded door mounted to the shroud exterior closes over the hole and is held by a magnetic latch.

Internally, five-inch-diameter aluminum ducting is attached to the fairing and jettisoned with it. The ducting arrangement is spacecraft peculiar.

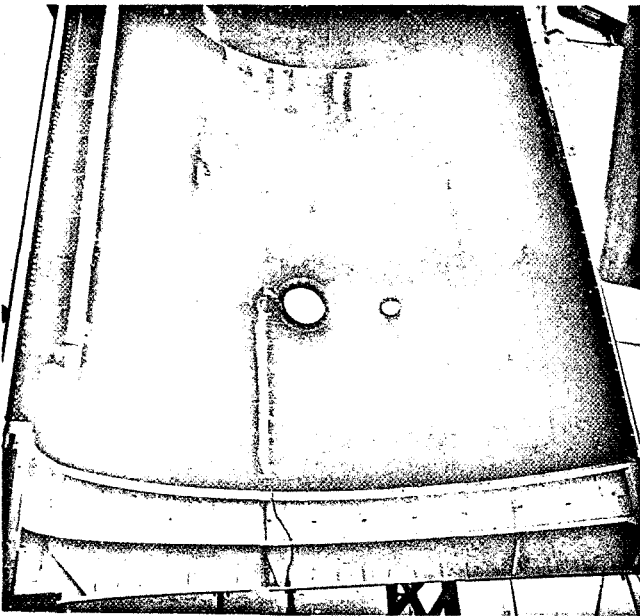

*Air-Conditioning Duct and Access Doors (Typical)*

## SPACECRAFT ACCESS

Access doors through the standard fairing to the spacecraft can be provided as required. Doors are bolted to the fairing and generally located about 90 degrees away from the fairing split line.

For Intelsat IV, five-inch and twelve-inch-diameter doors provide access on the pad to the safe/arm view tube

and electrical and instrumentation equipment. Pioneer G requires one 30-inch-diameter circular door for installation of the spacecraft radioisotope thermal generators and a second 30-inch door for personnel access.

## INTERFACES

### SPACECRAFT ADAPTERS

Payloads for Centaur D-1A are mounted to a mission-peculiar adapter that bolts to the Centaur equipment module.

Two adapters currently are in design — the Pioneer G and Intelsat IV. They are basically of the same conventional aluminum skin-stringer design, with machined forward aluminum rings. The adapter lengths and forward ring bolt hole patterns are slightly different:

	SC INTER-FACE (STA.)	LENGTH (IN.)	BOLT CIRCLE DIAMETER (IN.)	BOLT DIAMETER (IN.)	NO. OF BOLTS
PIONEER G	140.40	23.5	58.63	3/16	44
INTELSAT (PRELIMINARY)	145.15	18.75	58.016	1/2	8

The formed aluminum midframe provides a structure to which the removable GSE arms, used for mounting the encapsulated spacecraft to Centaur, attach.

The Pioneer G and Intelsat IV adapters are illustrated on the following page.

### SPACECRAFT WEIGHT AND CG

Structural capability of the equipment module is the limiting factor for sizing the payload or locating its center of gravity. This fact is shown in the following curves, which indicate allowable payload weights and centers of gravity based on the strength of the equipment module and the Centaur D-1A tank. Slight modifications can raise strength of the equipment module to that of the Centaur tank.



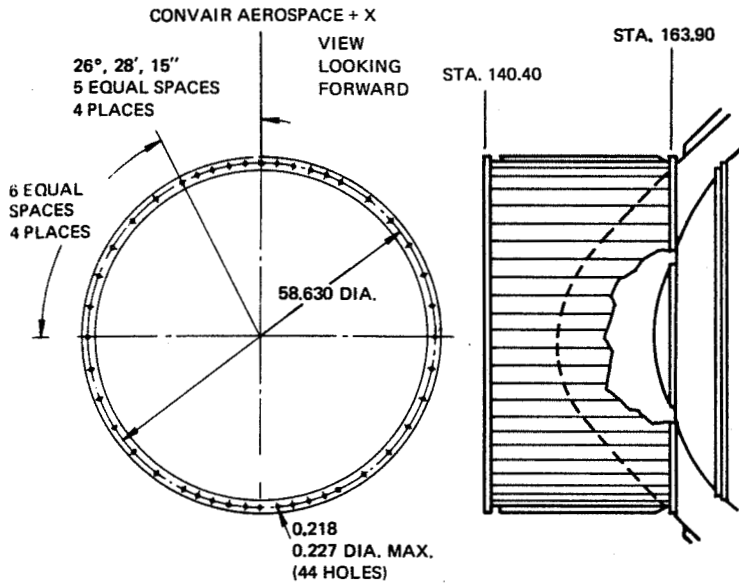

*Pioneer G Adapter*

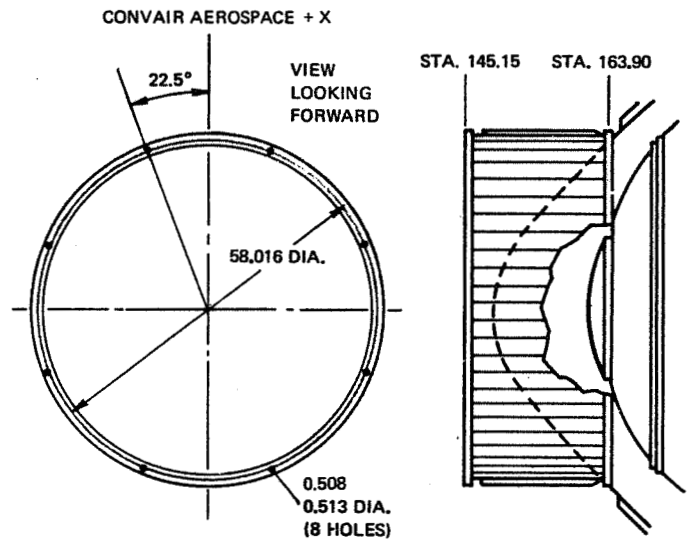

*Intelsat IV Adapter*

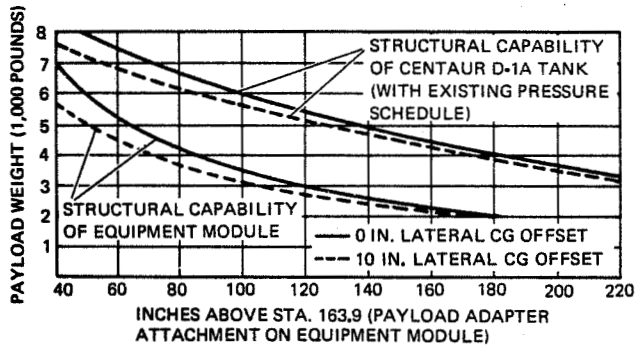

*Maximum Forward Location for Payload CG*

### ELECTRICAL INTERFACES

Illustrated at right are some of the electrical interfaces likely or possible between the spacecraft and Centaur. Many are optional services that Centaur can provide to the spacecraft.

### ELECTRICAL UMBILICALS (SAFE/ARM AND POWER/MONITOR)

The forward umbilical panel is attached to the equipment module just forward of the stub adapter.

Umbilical disconnects J3 and J4 are allocated for spacecraft use. Their use and functions are flexible,

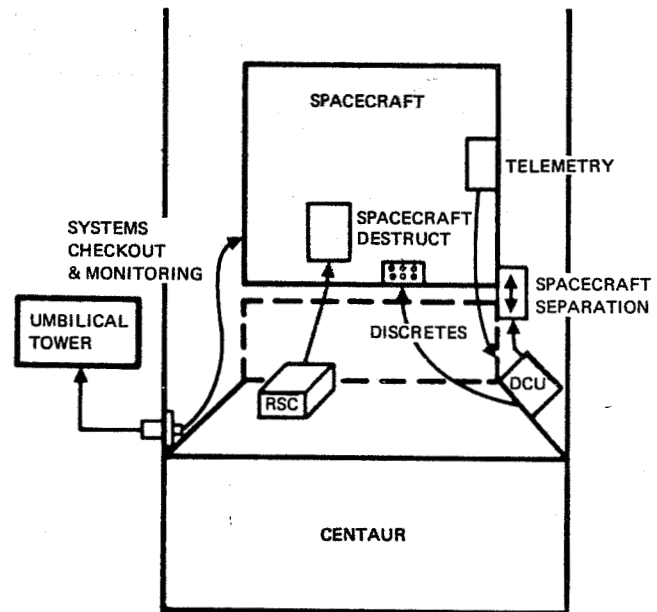

*Typical Electrical Interfaces*

depending on payload requirements. J3 is disconnected by hydraulically operated lanyards before liftoff (T minus 4 seconds). In general, it is used to monitor spacecraft systems. J4 stays connected until one-inch motion and has been used for such functions as safe/arm for the spacecraft rocket motor.

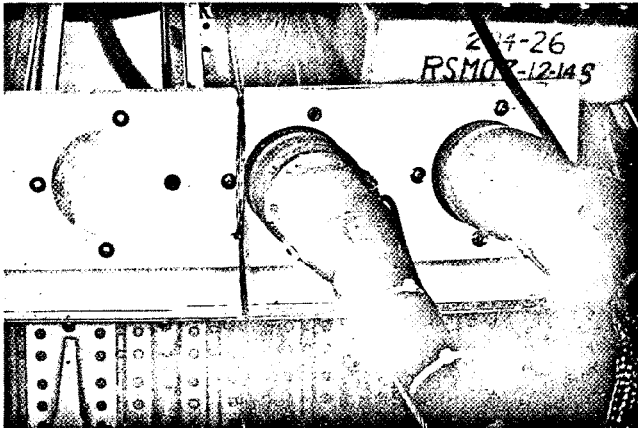

*Umbilical Panel on Equipment Module (Partial)*

From the umbilical panel to the spacecraft, these circuits are wired via a payload disconnect island, shroud inflight disconnects, or payload inflight disconnects. The payload disconnect island can accommodate electrical functions to payload, instrumentation, power for separation, or spacecraft pyrotechnics and detonator fuel lines for payload destruct.

	CONTACT COMPLEMENT	CLOCKING
J3	84-No. 16	50°
J4	74-No. 16 2-coax	20°

Connector configurations between J3 and J4 are interchangeable. Other contact arrangements can be made available with new clockings.

### SPACECRAFT SEPARATION SYSTEMS

Systems to separate the spacecraft from the launch vehicle are mission peculiar. Convair Aerospace can supply these or they can be provided by the spacecraft agency or contractor.

The separation sequence is initiated by a discrete from the Centaur guidance system. Centaur typically controls the spacecraft's pyrotechnically actuated separation system. These pyrotechnic control units can supply up to eight outputs per unit. Power is supplied from the main vehicle battery, with all necessary filtering

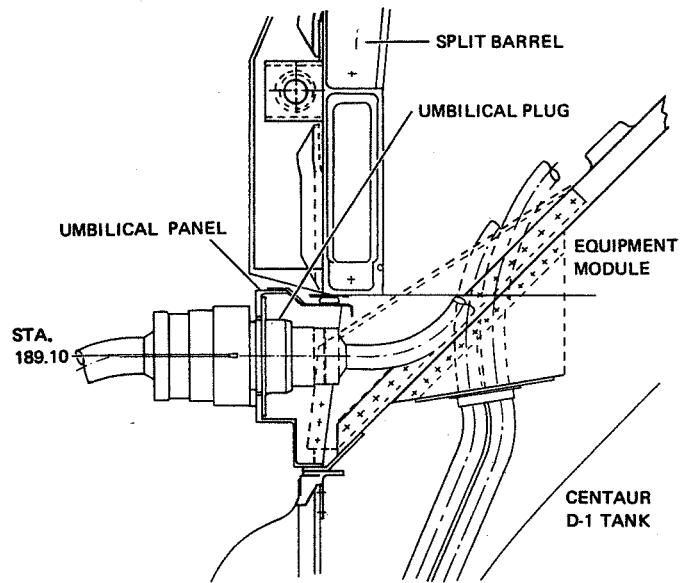

*Umbilical Plug*

occurring in each control unit. The units are typically designed to provide a minimum of five amperes per output.

### SPACECRAFT DESTRUCT OPTION

If desired, Centaur can provide a spacecraft destruct capability. An added arm/safe initiator receives the destruct command from the Centaur range safety command system. The initiator ignites electrically initiated detonators, which set off a booster charge. The charge ignites a mild detonating fuse, which, in turn, detonates a conically shaped explosive charge that then perforates the payload/third stage engine.

### COMMANDS AVAILABLE FOR SPACECRAFT USE

The Centaur sequence control unit (SCU) can provide as many as three isolated discrete commands to the spacecraft. These commands are in the form of contact closures from redundant relays. Each of the three contact closures is rated to carry either 7.5 amperes at 28 volts d-c or 3.5 amperes at 115 volts a-c (rms).

Closure of the relay contacts is controlled by the digital computer unit (DCU). Parallel digital data from the DCU is decoded in the SCU and the addressed relays are energized.

Excitation to the switch contact is normally provided from the spacecraft's own power system. The command provided by the contact closure is then electrically compatible with the "terminating load" in the spacecraft and electrically isolated from the Centaur stage.

All circuits have the additional option of providing the discrete command through an arm/safe switch contact, if desired. The arm/safe switch is a motor-driven device containing multiple two-pole double-throw switch contacts. On the safe position, it allows testing of the switch contact without activating the load. The contact is driven to the armed position by ground control just prior to launch. A variety of nonisolated (Centaur-powered) switch configurations is also available to the spacecraft.

An isolated parallel switch contact for each relay switch contact is used for monitoring the relay switch contact closure in flight by telemetry.

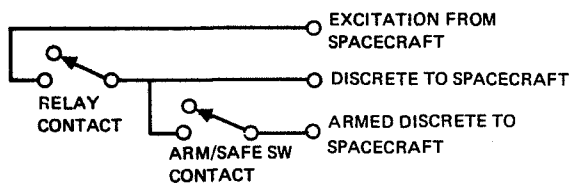

*Discrete Command Circuits*

Capability also exists in the sequence control unit to accept discrete inputs from the spacecraft. These commands are also meant to be electrically isolated switch contact closures. Excitation would be supplied from a Centaur battery through a current-limiting resistor.

#### TELEMETRY AVAILABLE FOR SPACECRAFT USE

The Centaur pulse code modulation (PCM) telemetry is a time division multiplex system under control of the digital computer unit. Remote multiplexer units (RMU) minimize cabling and provide a convenient means for handling Centaur instrumentation information as well as that from the lower stage and the spacecraft, if desired. The digital computer unit has the capability of accepting inputs from four RMUs. Centaur employs two RMUs, and when the third RMU operates with the Atlas booster, it handles Atlas instrumentation data. The remaining RMU or two RMUs (when Centaur is on Titan) could be used by the spacecraft.

#### ENVIRONMENT

Environmental data presented here is general in nature and may vary for a specific mission and spacecraft. The data represents recommended flight acceptance and not qualification test levels. Qualification test levels are considered to be at least 50% higher than these flight acceptance test levels.

#### ENVIRONMENT SENSING

A flexible capability exists to measure the environment around a spacecraft. Sensors as required for a specific mission are attached at appropriate places on the shroud or adapters and data sent back to ground via the Centaur telemetry system.

Examples of environmental data are:

1. Pressure inside and outside fairing
2. Pressure differentials across diaphragm from spacecraft to Centaur equipment module
3. Internal temperature
4. Accelerations on payload adapter

Data can also be measured by spacecraft systems and sent back via the Centaur telemetry system as described earlier in this chapter.

#### SPACECRAFT ENVIRONMENTAL TESTING

Convair Aerospace assists the spacecraft contractor in developing his environmental testing requirements by analyzing the various preflight and flight environmental conditions. The Convair test facilities are also available for use by the spacecraft contractor, if desired. Development or acceptance vibration tests of Mariner, Surveyor, and OAO were done at Convair Aerospace, plus the full range of environment simulations for OV1 and SECOR.

#### VIBRATION

Maximum vibration regimes occur during the launch and transonic times of flight. Motion of the Centaur/payload interface may be divided into two discrete regimes: low-frequency sinusoidal vibration excitation, which tends to design major portions of the payload structure; and high-frequency broadband random vibration excitation, which tends to design component support structures, etc. To minimize payload dynamic loads, payload lateral and longitudinal frequencies below 10 Hz should be avoided. Both theoretical analyses and laboratory tests should be performed to demonstrate that the design of each payload

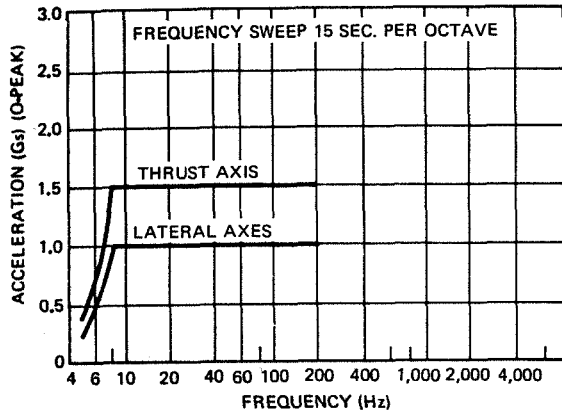

Recommended Sinusoidal Vibration Environment (Sweep)

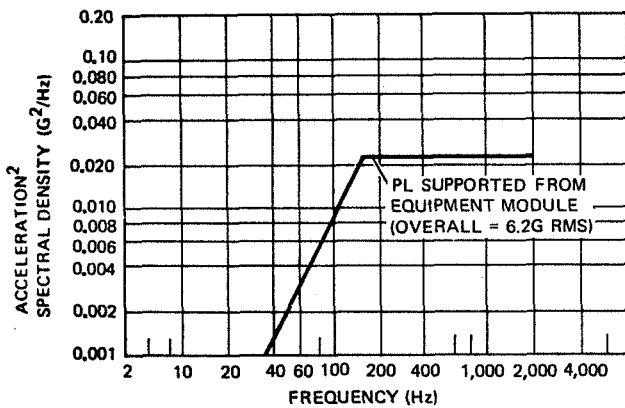

Recommended Random Vibration Spectrum

will function within prescribed tolerances during exposure to maximum expected vibratory excitation.

For preliminary purposes, the spacecraft should be designed to withstand the sinusoidal and random acceptance vibration tests, as shown above. For anything except very rigid, simple spacecraft, the test levels and procedures should be developed specifically to include notching of the excitation amplitude over specific frequency ranges by limiting response of the payload center of gravity in accordance with analytical results.

### ACOUSTIC

Maximum acoustic noise levels occur at launch (due to engine noise) and in the transonic region (due to aerodynamic noise created by boundary layer fluctuations). Payload components should be capable of functioning during one minute of exposure to the

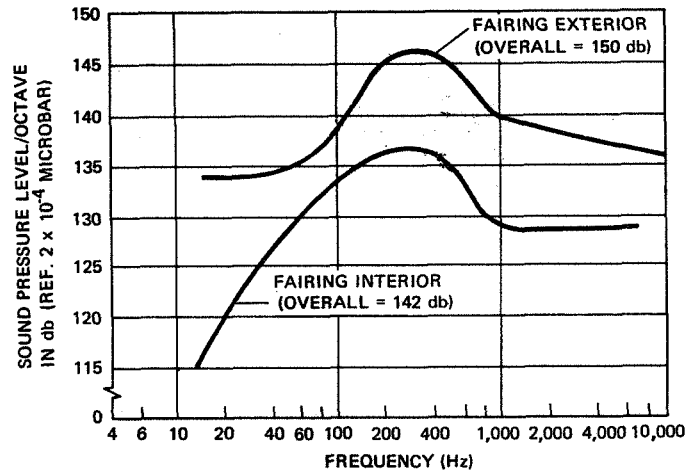

Recommended Acoustic Environment

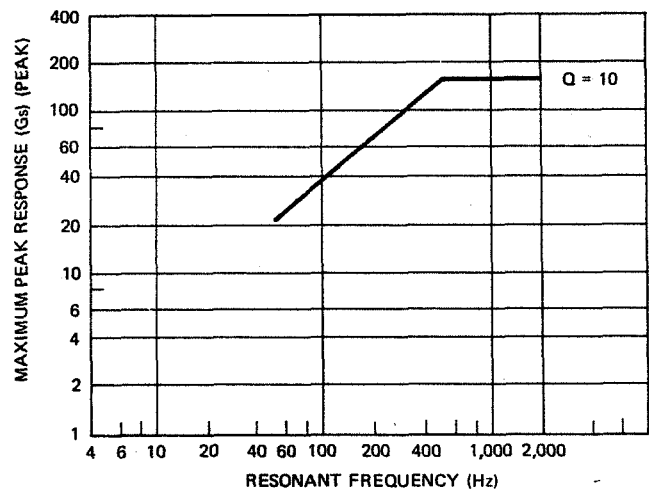

Recommended Shock Environment

indicated acoustic spectrum, which is an overall sound pressure environment of 142 decibels.

### SHOCK

The most significant shocks occur during insulation panel jettison, when a linear shaped charge separation system cuts the structural joints of the external panels.

Shocks may also occur at Atlas/Centaur separation and payload separation. These shocks, however, are lower than the indicated shock spectra.

### PAYLOAD LIMIT LOAD FACTORS

Every element of the payload structure and substructure must be designed, with the appropriate margin of

confidence, to function during all expected loading conditions. This includes flight and ground-handling loads. The flight loads are likely to be most critical during launch, transonic/maximum aerodynamic pressure, booster staging, maximum forward acceleration, or Centaur thrust cutoff. The equivalent static design loads are calculated as the product of design limit load factors and the weights of the subject payload structure.

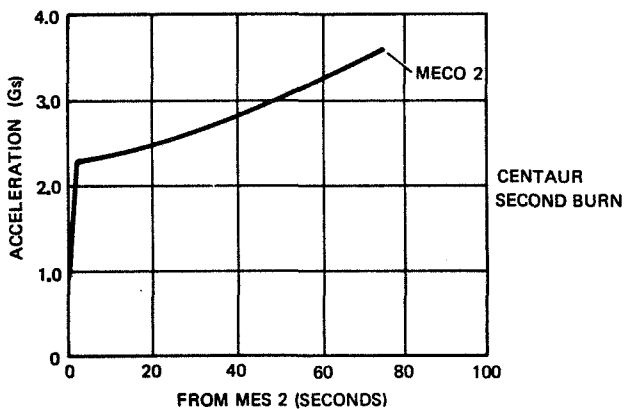
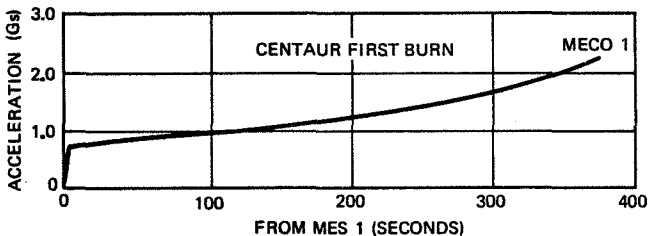
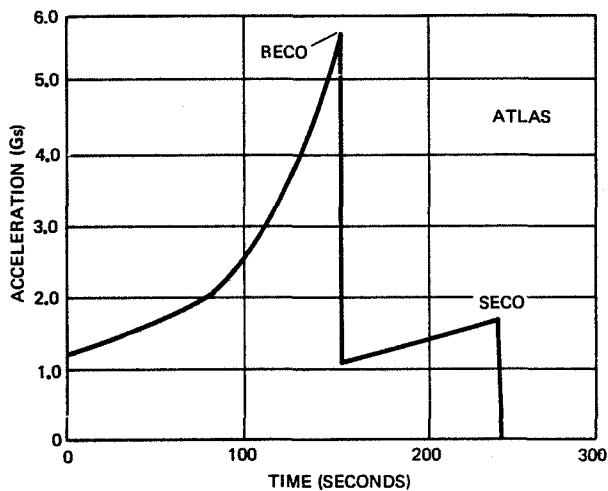

*Axial Load Factors for Atlas/Centaur Flight (3,000-pound payload)*

The curves shown here represent typical static axial load factors obtained from trajectory parameters of gross vehicle thrust, drag, and weight for an Atlas/Centaur vehicle with a 3,000-pound payload. In addition to the steady-state accelerations, various transients may be expected. Loads developed from these transients are between 1.5 and 3.0g laterally and between 1 and 4g axially. Actual values are highly sensitive to design of individual payloads, with some tendency to decrease as payload weight increases.

**THERMAL**

**PRELAUNCH ENVIRONMENTAL CONTROL** – The thermal environment for the spacecraft is carefully controlled during all prelaunch phases. This includes encapsulation in the explosive-safe area, transport to launch pad, mating to the Centaur, and prelaunch checkout. During transport to Pad 36, pressure bottles attached to the ground transport vehicle maintain a positive pressure and environmental control inside the fairing. The pad spacecraft area is protected from wind and rain and can be closed to provide temperature and humidity control.

On the pad, air conditioning is provided to the spacecraft via an umbilical. Air-conditioning requirements are defined during an analysis done for each launch. (See page 3-24 for air-conditioning capabilities.)

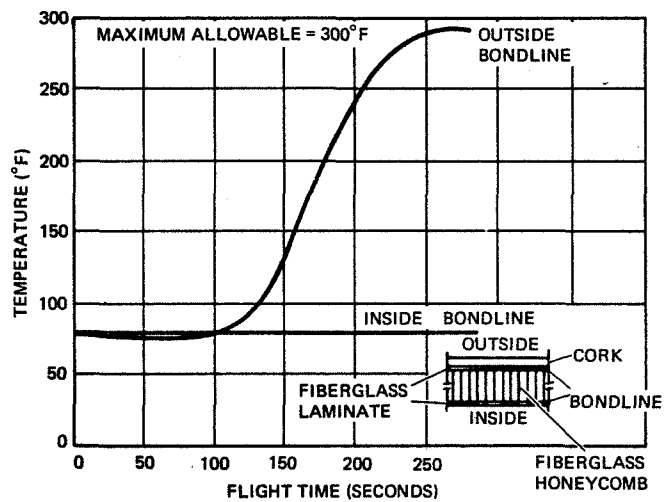

*Fairing Maximum Bondline Temperature Predictions (Conical Portion)*

**ASCENT PHASE** – The fiberglass Atlas/Centaur standard fairing protects the spacecraft during the ascent trajectory phase. The fairing is normally jettisoned twelve seconds after Centaur main engine ignition, at an altitude of nearly 500,000 feet. At this time the three-sigma worst free molecular heating value is below 80 Btu/ft.<sup>2</sup>-hr.

**SPACE** – Space heating of payload components after shroud jettison is based upon thermal, thermophysical, and geometrical characteristics of the component in question. Additional factors influencing the intensity of incident heating rates are launch day, launch hour, vehicle orientation, and orbital attitude.

Direct ascent, deep-space missions can subject the payload to a second peak of free molecular aerodynamic heating several minutes after shroud jettison for certain combinations of low injection altitude and zero or negative injection flight path angles. Typical payload maximum aerodynamic heating constraints during this one-to-three-minute period are 150 to 250 Btu/ft.<sup>2</sup>-hr. and are satisfied by raising injection altitudes up to 125 nautical miles for interplanetary trajectories.

### PRESSURE

The payload compartment pressures inside the fairing follow closely the flight atmospheric pressures, with the internal pressure dropping faster than the ambient. An exception to this occurs during the transonic region around 60 to 65 seconds after liftoff.

The pressures shown at right are for a payload compartment at the same pressure as the Centaur equipment module (as on Intelsat IV and Pioneer). If necessary for spacecraft cleanliness, a seal can be placed across the thermal bulkhead between the payload and the equipment module. Fairing vents are located in the split barrel area below the spacecraft/Centaur interface.

### LAUNCH FACILITIES

The Atlas/Centaur D-1A is launched from Launch Complex 36A and B at the Eastern Test Range. Prelaunch and launch operations of the launch vehicle and spacecraft are under the direction of Kennedy Space Center Unmanned Launch Operations. Convair Aerospace supports these operations under contractual direction from the Lewis Research Center, including encapsulation and mating of spacecraft to Centaur.

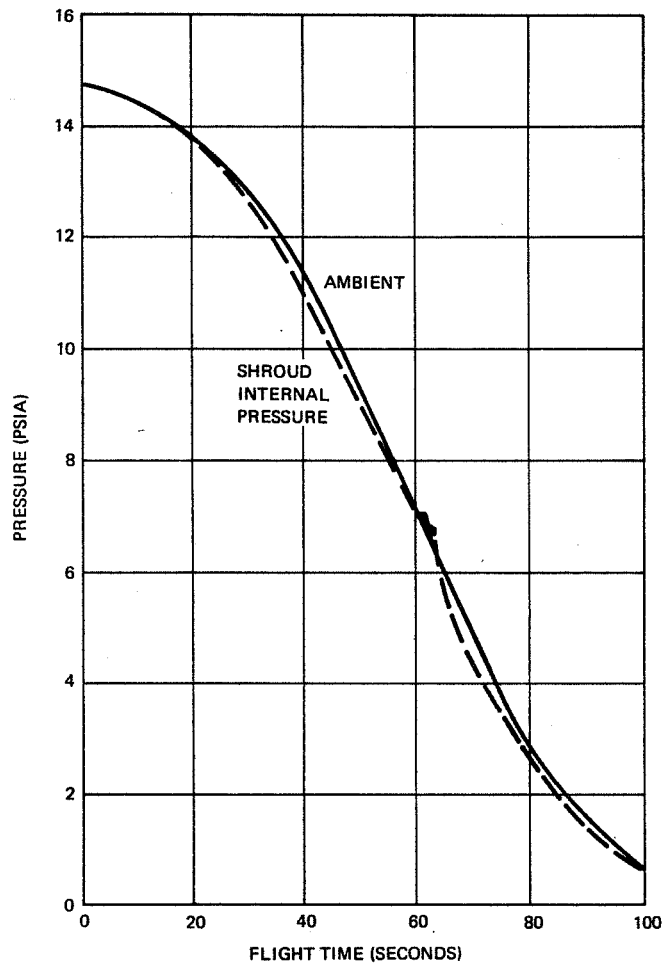

*Typical Fairing Pressures*

Eastern Test Range facilities are described in detail in the Handbook of Unmanned Spacecraft Operations at Eastern Test Range, originally issued on 1 June 1968 by the Unmanned Launch Operations Group.

### LAUNCH COMPLEX 36

Launch Complex Pads 36A and B share a common blockhouse, instrumentation, and launch control equipment.

Mobile service towers (MST) at each pad provide a protected work area for spacecraft mating and checkout. They are moved away from the launch pad before cryogenic tanking, about 120 minutes before launch.

The fixed umbilical tower provides instrumentation lines, fuel, power, and purging gas to Centaur and the spacecraft by means of umbilical booms. The booms pull



Launch Complex Pads 36A and B

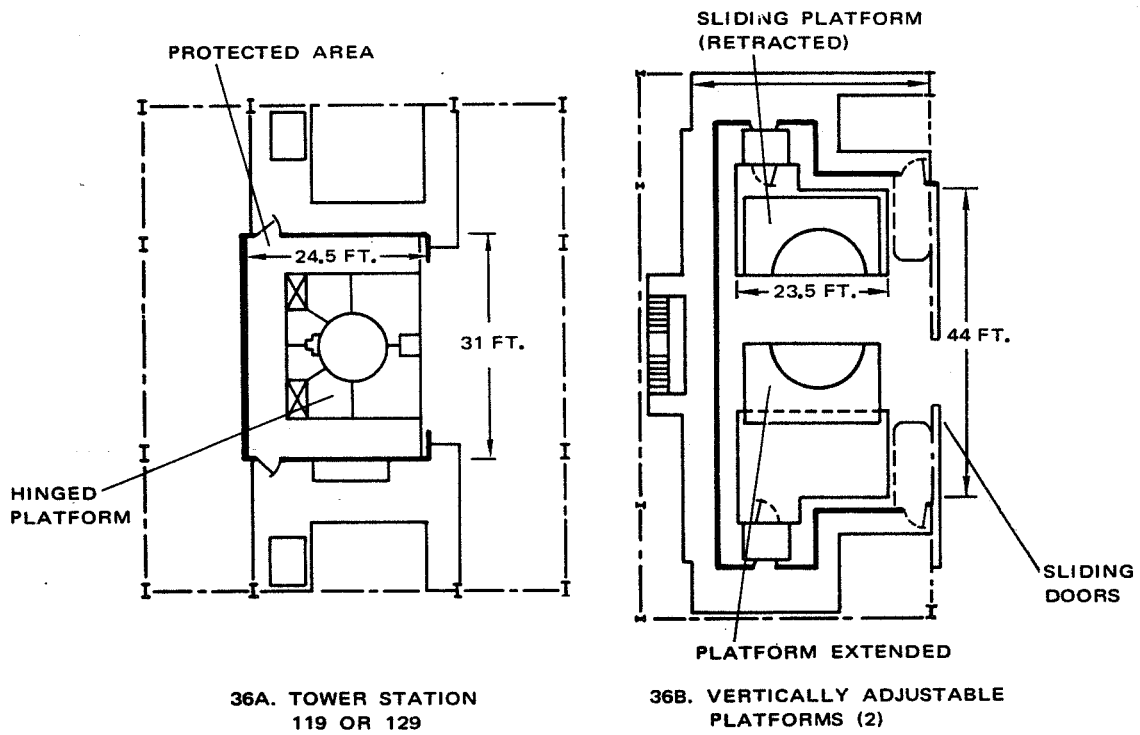

Launch Pad Spacecraft Work Platforms

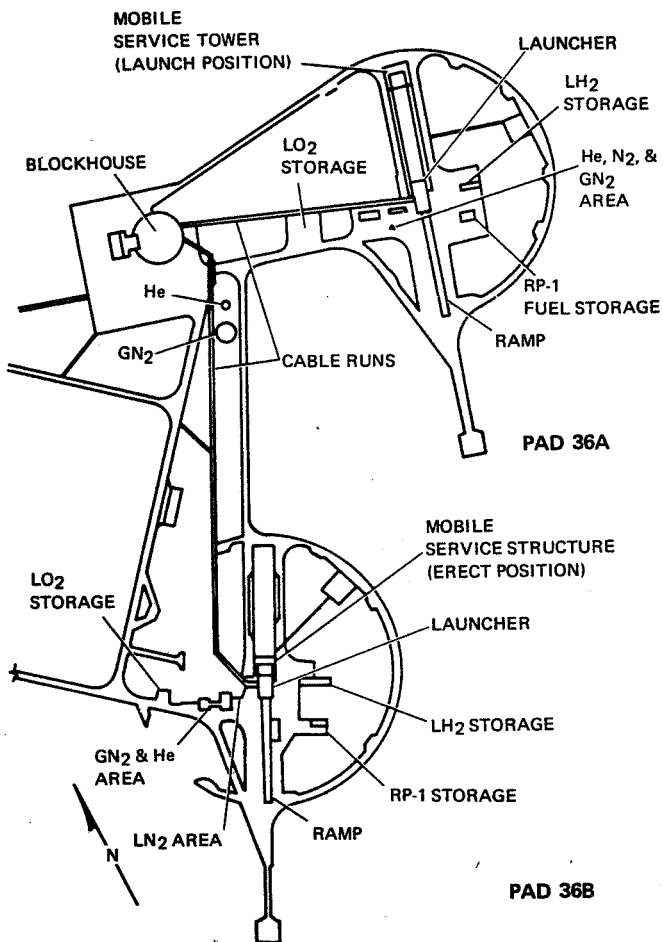
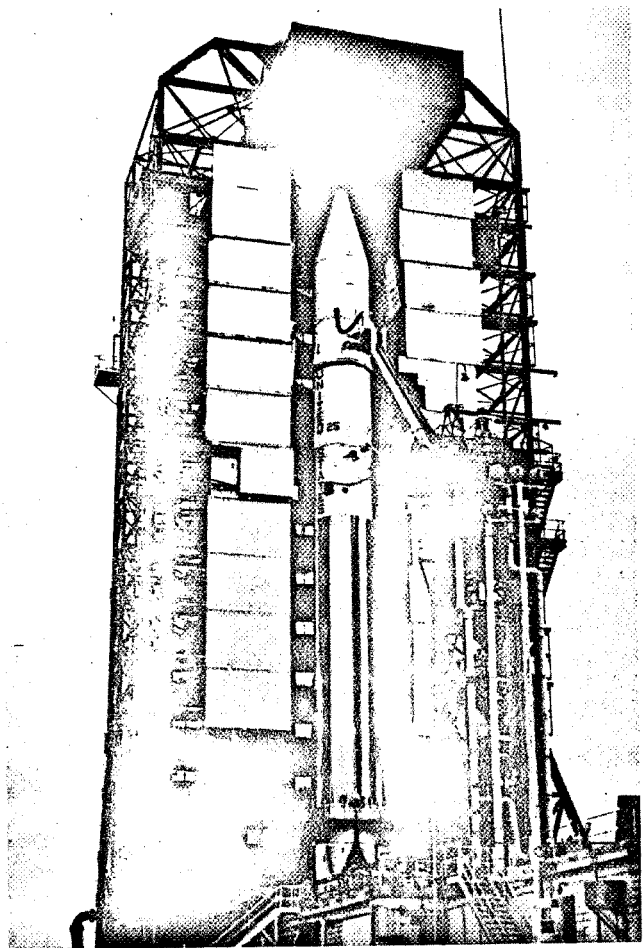

Diagram of Launch Complex 36



Intelsat IV Launch Vehicle on Pad 36A

lines clear at liftoff and swing clear of the ascending vehicle. A catwalk connects the umbilical tower to the mobile service tower.

### LAUNCH PADS

Summarized below are specifications for the two pads at Complex 36.

#### Specifications for Launch Pads 36A and 36B

ITEM	PAD 36A	PAD 36B
MST SPACECRAFT WORK PLATFORMS	FIXED AT 10-FOOT INTERVALS	VERTICALLY ADJUSTABLE
SPACECRAFT AREA ENVIRONMENT	AIR CONDITIONED IF REQUIRED	AIR CONDITIONED
BRIDGE CRANE		
CAPACITY	10 TONS	10 TONS
HOOK HEIGHT (TOWER STATION: TS)	161 FEET	191 FEET
CENTAUR D-1A FAIRING TIP (TS)	152 FEET, 8 INCHES	152 FEET, 8 INCHES
GROWTH CAPABILITY (AFTER SLING & HYDRASET CLEARANCE)	2.5 FEET	32 FEET



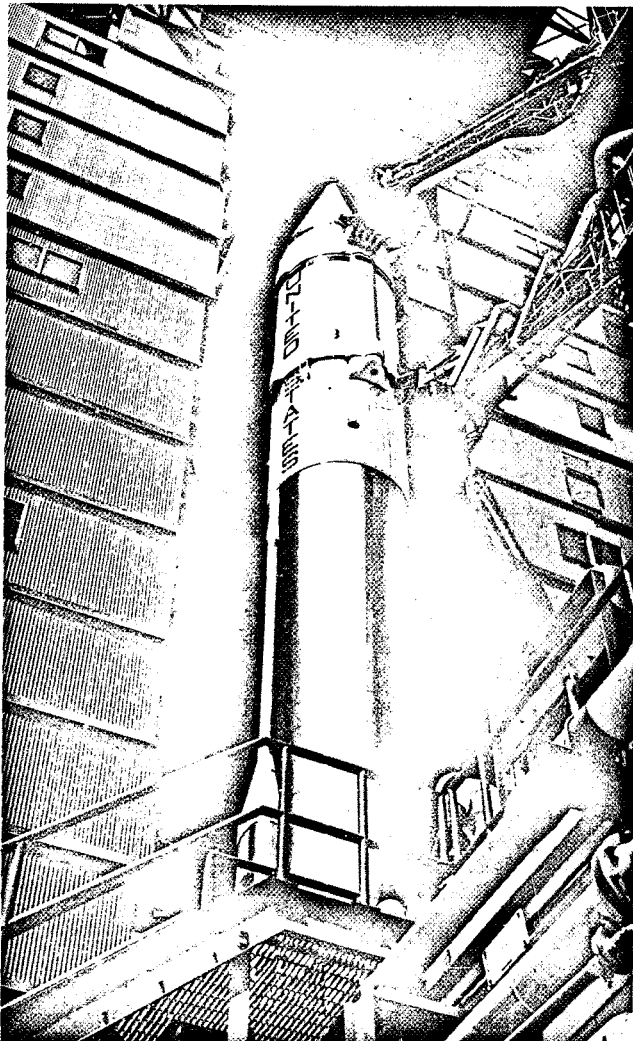

*Mariner '71 Launch Vehicle on Pad 36B*

### PAD SPACECRAFT SERVICES

**POWER** – 60 and 400 Hz at 120 and 208 volts, single and three phase; 60 Hz at 408 volts; 28 volts d-c.

**AIR CONDITIONING** – Air or GN<sub>2</sub>. Volume 40 to 100 pounds per minute, pressure 0 to 30 inches of H<sub>2</sub>O, temperature 60 to 100 degrees F (± 5 degrees F), humidity 40 degrees F dewpoint maximum (lower with GN<sub>2</sub>).

**GN<sub>2</sub>** – For purge, available at most MST levels and from umbilical tower. Pressures up to 2,200 psig (36A) and 3,400 psig (36B).

**HELIUM** – For purge or pressurizing. Gas at pressures up to 6,000 psig.

**MOUNTING** – Mounting provisions and cabling for

reradiating spacecraft signals from inside MST to remote sites.

### BLOCKHOUSE

A single blockhouse controls launches on both Pad 36A and Pad 36B. Connected to both pads by cable tunnels, the blockhouse contains all the necessary electrical and communication equipment to conduct a launch from either pad.

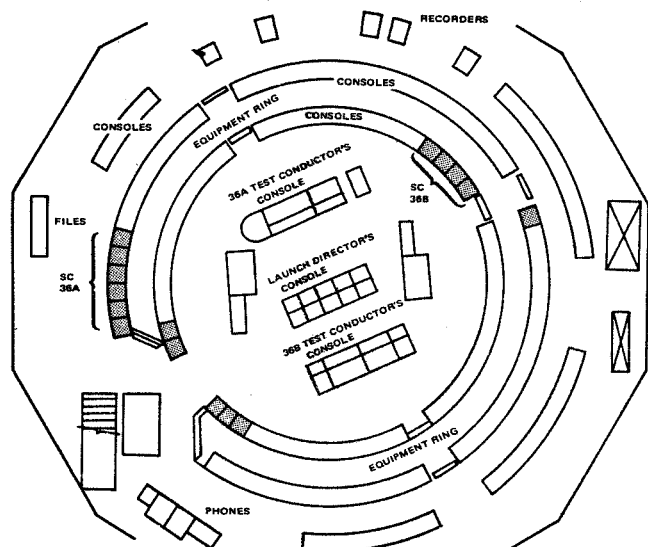

*Complex 36 Blockhouse*

Space is available for spacecraft ground support equipment. Isolated cabling from the blockhouse to the launch pad is for spacecraft ground checkout. Wideband data circuits are available for connection to spacecraft checkout facilities (Building AO) and to tracking networks.

### PROCUREMENT AND MANUFACTURE

Nominal procurement time for Centaur D-1A is 23 months from contract go-ahead to vehicle acceptance (DD250). Nominal vehicle launch date is 26 months from go-ahead. NASA requires time before go-ahead for mission definition and contract execution, typically about six months. Under unusual circumstances this schedule can be compressed. Intelsat IV was launched 22 months after Comsat's selection of Atlas/Centaur as the launch vehicle.

Nominal procurement lead time for Atlas SLV-3D is 18 months to DD250.

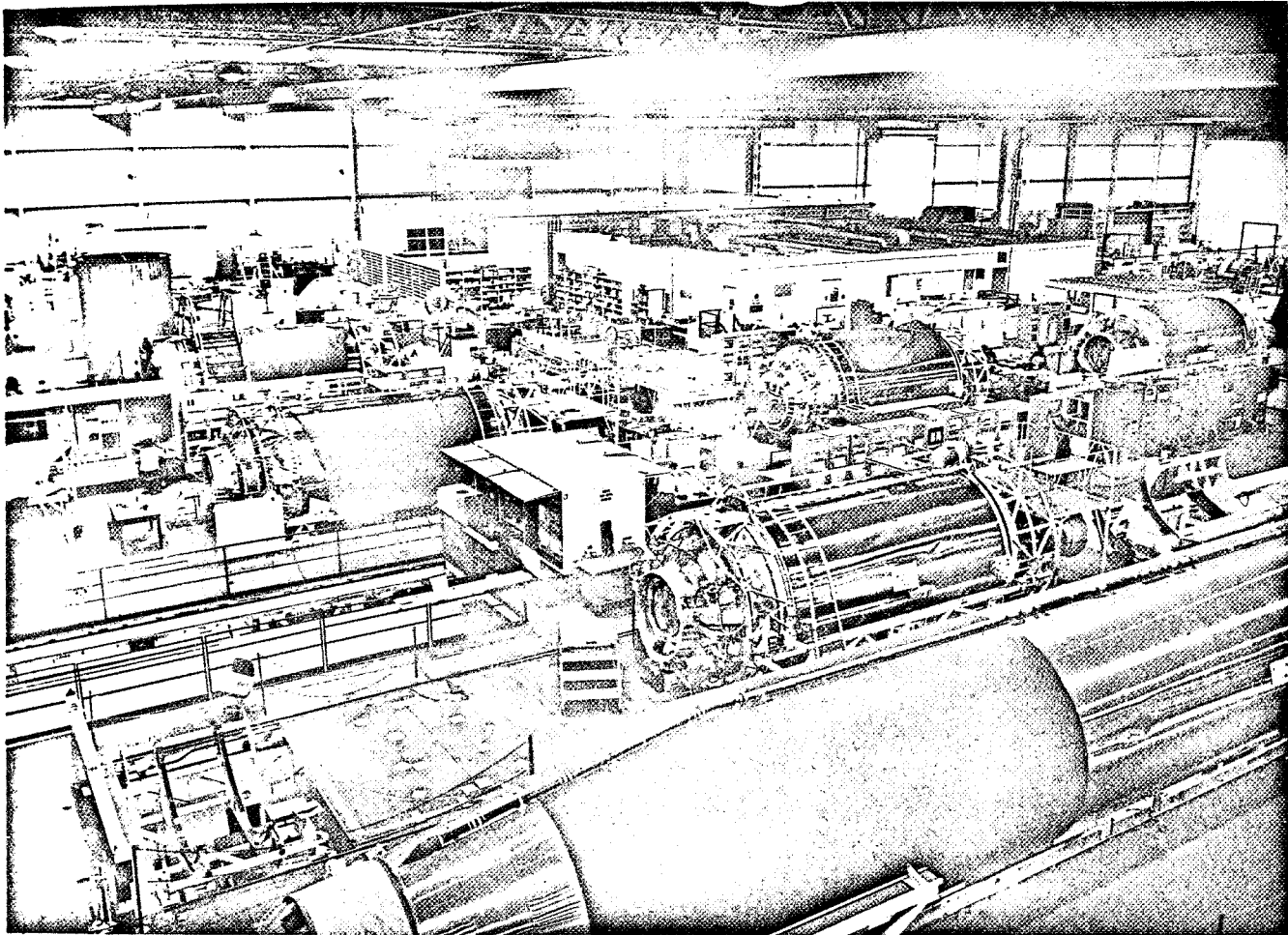

Convair Aerospace Atlas and Centaur Assembly Area

*Centaur Go-Ahead to Launch Schedule*

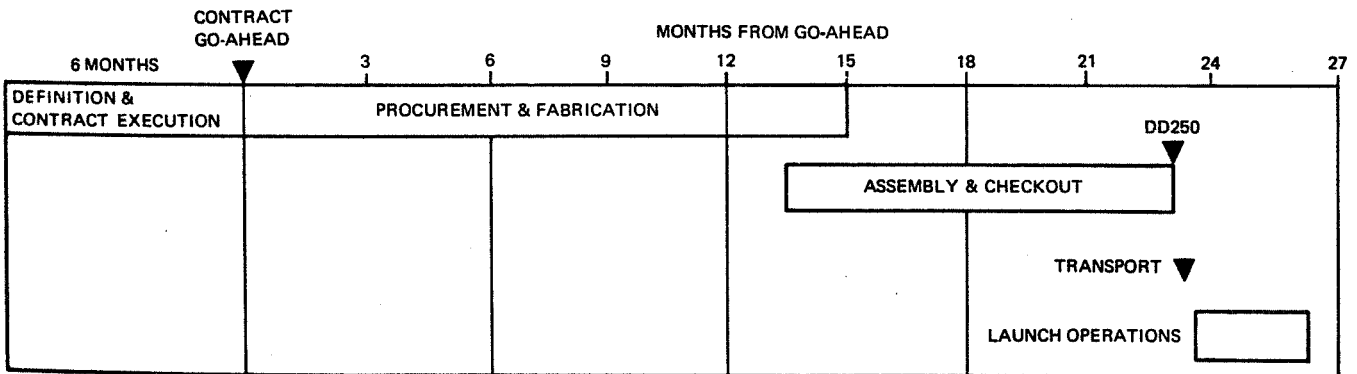

# FABRICATION SEQUENCE

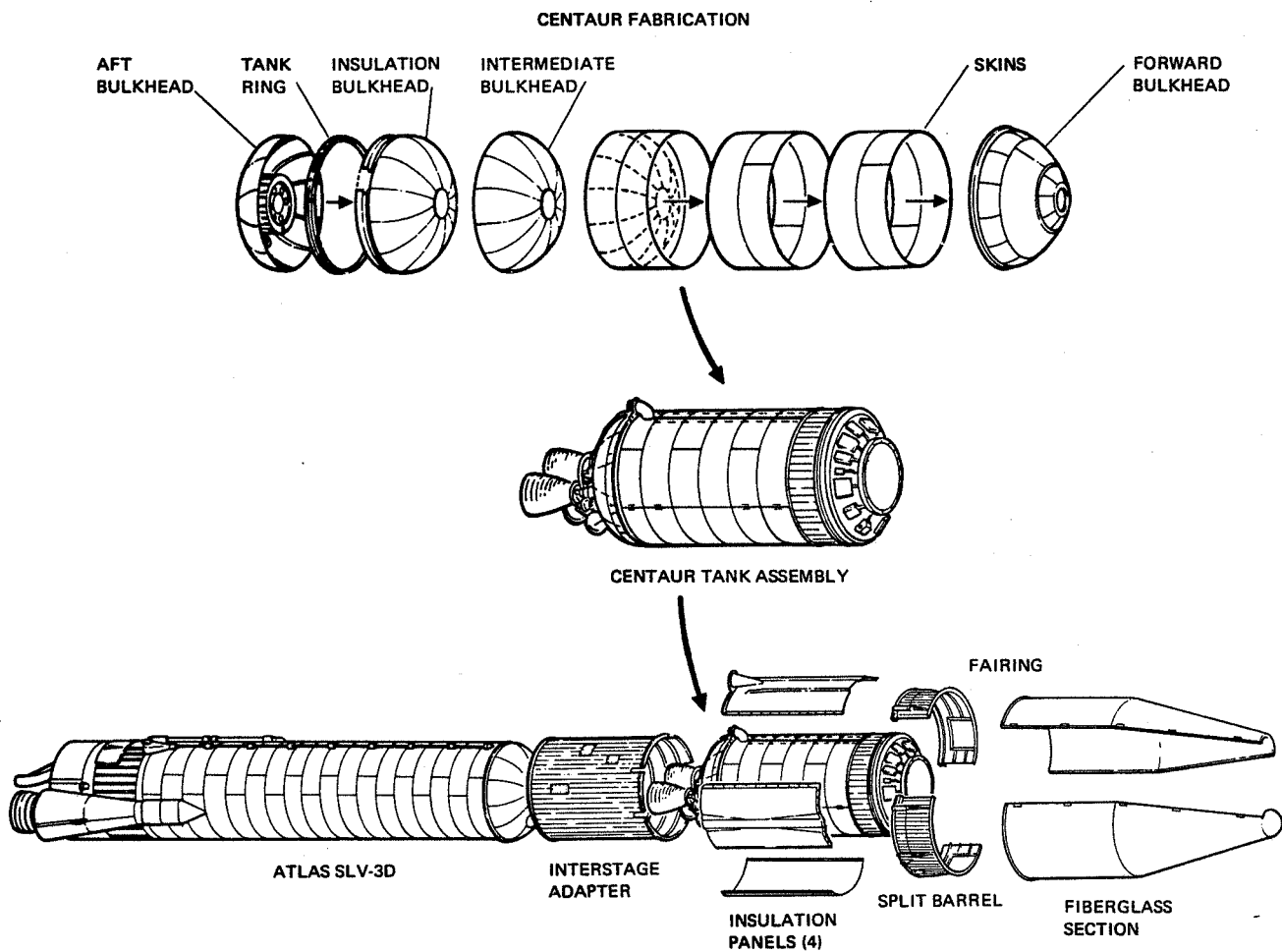



TITAN/CENTAUR

## TITAN/CENTAUR

SUMMARY	4-3
DESCRIPTION	4-4
PERFORMANCE	4-5
FLIGHT PROFILE	4-6
ACCURACY	4-10
SHROUD AND ENVELOPE	4-10
INTERFACES	4-11
ENVIRONMENT	4-13
LAUNCH FACILITIES	4-15
PROCUREMENT	4-18

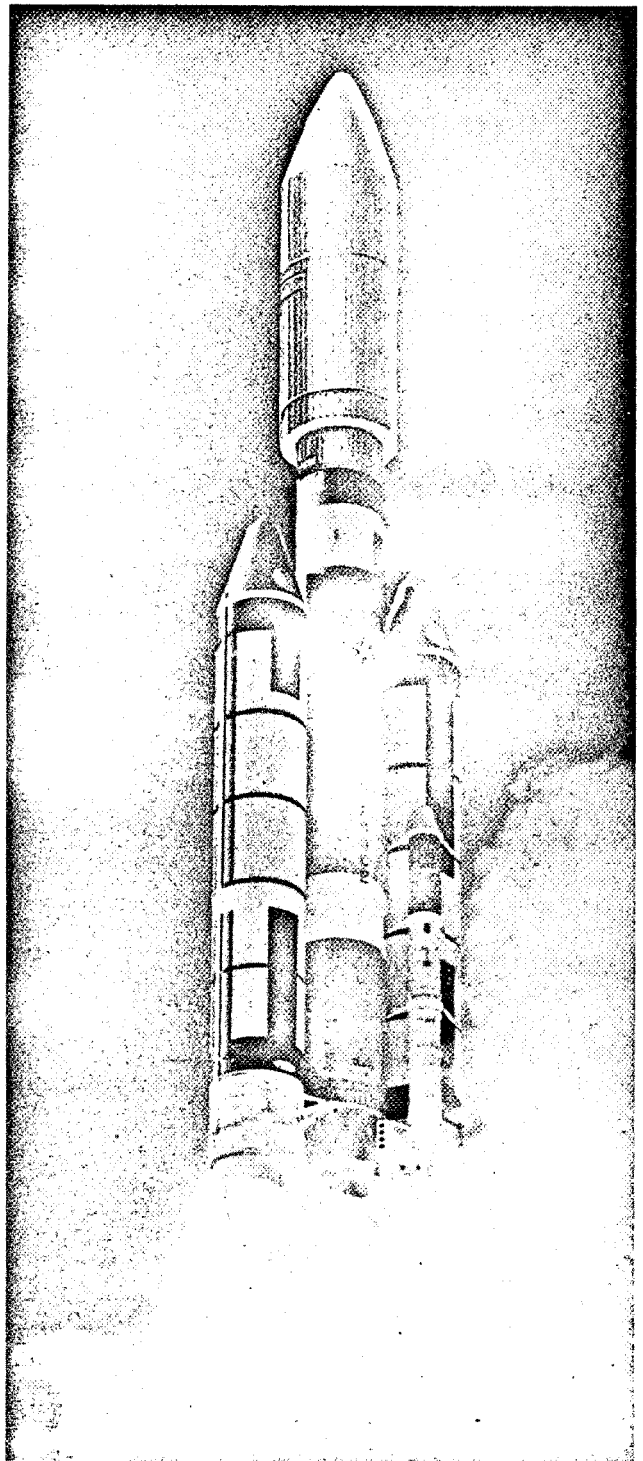
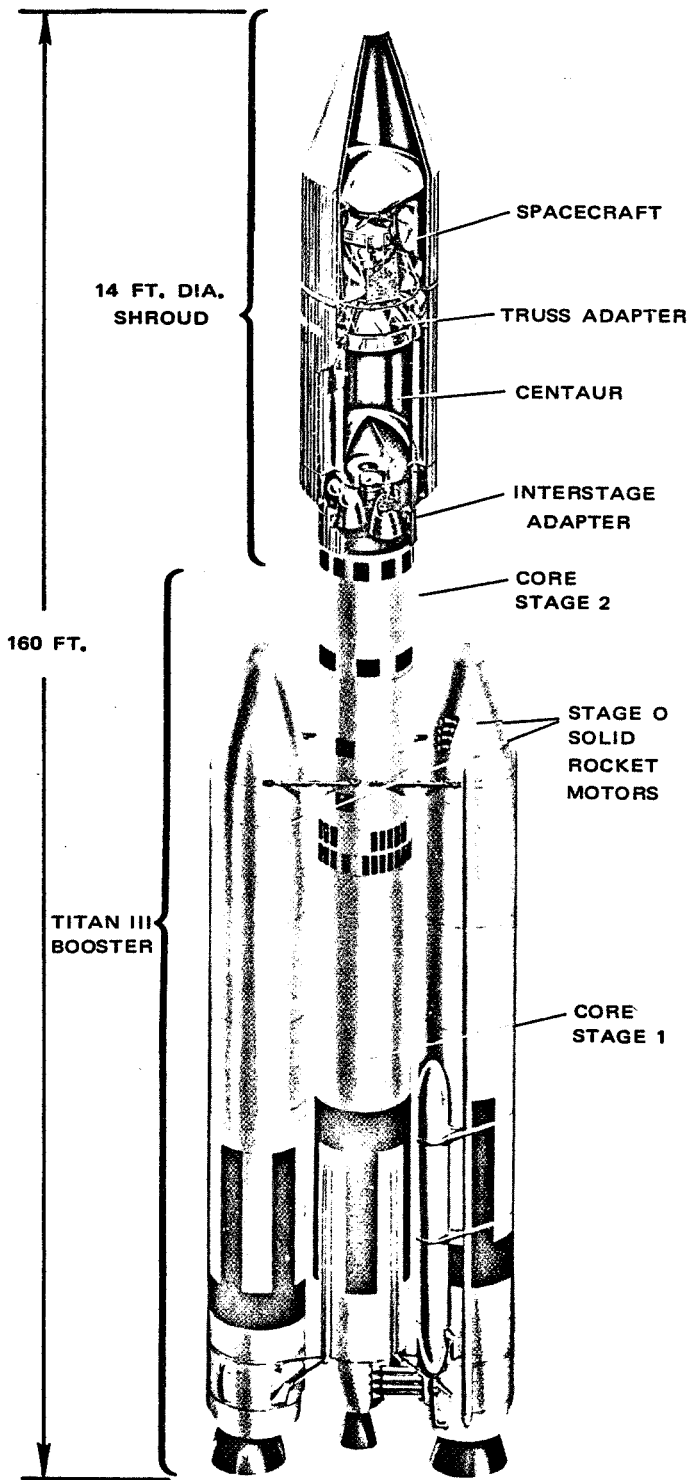

## TITAN/CENTAUR D-1T SUMMARY

**BOOSTER:** TITAN III (CENTAUR). FIVE-SEGMENT SOLID ROCKET MOTORS; LIQUID PROPELLANT IN STAGES 1 AND 2

**UPPER STAGE:** CENTAUR D-1T

**STATUS (JUNE 1971)** IN DEVELOPMENT; OPERATIONAL IN 1974

**SCHEDULE:** PROOF FLIGHT (FOUR CENTAUR BURNS) IN JANUARY 1974

HELIOS SUN PROBE LAUNCHES IN 1974 AND 1975

DUAL VIKING MARS LANDER LAUNCHES IN 1975

**PERFORMANCE CAPABILITY:** LAUNCH FROM EASTERN TEST RANGE:

- 100 N.MI. CIRCULAR: 34,000 LB.
- SYNCHRONOUS TRANSFER: 15,500 LB.
- SYNCHRONOUS EQUATORIAL (THREE-BURN CENTAUR): 8,400 LB.
- ESCAPE:
  - $C_3 = 20 \text{ km}^2/\text{sec.}^2$ : 7,400 LB.

**PROCUREMENT LEAD TIME:** CENTAUR D-1T:  
(ROUTINE) 22 MONTHS TO DD250  
25 MONTHS TO LAUNCH

TITAN III BOOSTER:  
24 MONTHS TO LAUNCH

**LAUNCH SITE:** EASTERN TEST RANGE LAUNCH COMPLEX 41

## LAUNCH VEHICLE DESCRIPTION

Centaur is being integrated onto Titan III initially for high-performance escape missions. In addition, this combination is particularly applicable for large spacecraft in synchronous orbits. Total length of the Titan/Centaur with the 14-foot-diameter Centaur Standard Shroud is 160 feet. Centaur is enclosed by the shroud. Total liftoff weight is 1.41 million pounds. Thrust shortly after liftoff is about 2.3 million pounds.

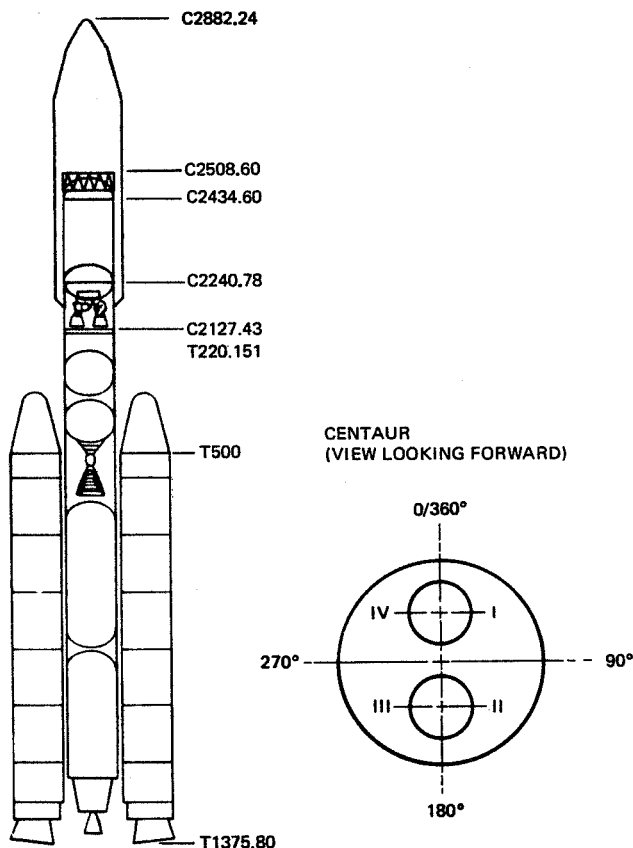

### TITAN III BOOSTER FOR CENTAUR

The Titan III consists of two liquid propellant core stages and two strap-on solid rocket motors (SRMs). The two solids are ignited at liftoff, burn out about two minutes into flight, and are jettisoned. The first-stage liquid engine, ignited shortly before SRM burnout, burns for

two and a half minutes. The core second stage separates and burns for three and a half minutes. Centaur then separates and continues the mission until spacecraft injection.

The five-segment solid-propellant rocket motors made by United Technology Center are ten feet in diameter and 85 feet in length. The oxidizer is ammonium perchlorate. The fuel is powdered aluminum along with the synthetic rubber binder. Thrust vector control is provided by injection of pressurized liquid nitrogen tetroxide into the nozzle cone, which deflects the rocket's exhaust gases.

The ten-foot-diameter core stages are made from aluminum skins, with longitudinal T-shaped aluminum stringers integrally milled. Tank domes and skirts separate the forward oxidizer tanks and the aft fuel tanks. The tanks are pressurized. Length of the first stage is 72.9 feet; of the second stage 23.3 feet.

Propellants for the two liquid stages are a 50-50 blend of hydrazine and unsymmetrical dimethylhydrazine (UDMH) fuel combined with nitrogen tetroxide ( $N_2O_4$ ) oxidizer. The stage 1 propulsion system is an Aerojet YLR87-AJ-11 assembly that has two gimbaling thrust chambers. A single thrust chamber is used in the stage 2 Aerojet YLR91-AJ-11 assembly. Both systems are pump fed.

Control for stage 1 is achieved by gimbaling the engines. The gimballed main engine provides pitch and yaw control in stage 2, with the gas generator exhaust providing roll control. Guidance commands come from the Centaur system while stability is by the Titan flight control system.

### PROPULSION SYSTEM SUMMARY

<b>RATED THRUST</b>	
SRMs (SEA LEVEL)	2,341,000 LB.
CORE STAGE 1 (VACUUM)	523,000 LB.
CORE STAGE 2 (VACUUM)	102,300 LB.
<b>RATED VACUUM <math>I_{sp}</math></b>	
SRMs	266 SEC.
LIQUID STAGE 1	301 SEC.
LIQUID STAGE 2	317 SEC.
<b>TOTAL IMPULSE (VACUUM)</b>	
SRMs (EACH)	113,000,000 LB./SEC.



## PERFORMANCE

Ascent modes for the Titan/Centaur are:

- LOW EARTH ORBIT:** Direct ascent or Hohmann transfer
- SYNCHRONOUS:** Hohmann transfer with spacecraft apogee kick motor or three-burn Centaur
- ESCAPE:** Direct injection or parking orbit with TE-364-4 or Burner II for higher velocities

### PERFORMANCE GROUND RULES

Vehicle weights, performance parameters, and sequencing used in trajectory simulations are based on ground rules established between Convair Aerospace and Martin Marietta.

Titan/Centaur performance determination is based on:

- Launch Site: ETR LC 41  
 Launch Azimuth: 90 deg.  
 Parking Orbit: 100 n.mi. circular  
 Shroud: 14-ft. diameter (6,700 lb.)

Jettison Shroud: Stage II ignition plus 25 sec. (6,060 lb.)

Propulsion:  
 Titan 5-segment SRMs See page 4-4  
 Titan 7-segment SRMs  
 Thrust (SL) 2,826,000 lb.  
 I<sub>sp</sub> (vac.) 269 sec.  
 Centaur See page 2-1

All payload capabilities account for the Centaur flight performance reserve, including allowance for three-sigma flight conditions.

### GENERALIZED PAYLOAD CAPABILITY

Overall payload capability of the Titan/Centaur (the Titan with five solid segments) for an ETR launch is shown in the chart below. Also shown is the payload capability for a growth version of Titan that has seven solid segments. (See page 6-3 for growth Titan.)

### CIRCULAR ORBITS

The illustration on page 4-8 presents the Titan/Centaur D-1T circular orbit performance capability when using the Hohmann transfer two-burn injection mode. Payload losses due to added batteries, attitude control, propellants, or propellant losses during coast are accounted for.

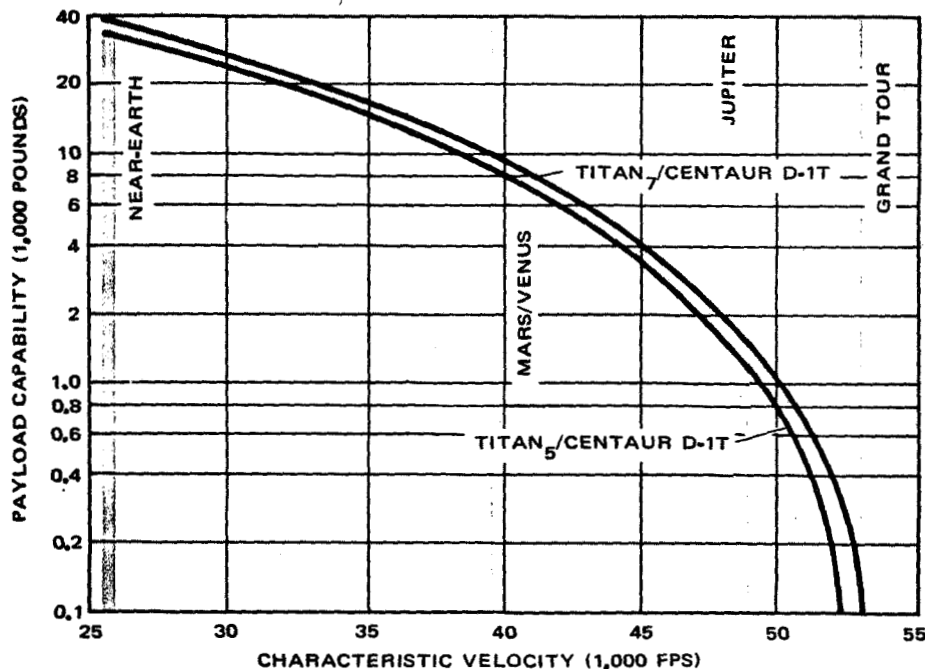

Generalized Titan/Centaur Payload Capability

# TITAN/CENTAUR FLIGHT PROFILE FOR TWO-BURN MISSION

Flight characteristics for Titan/Centaur D-1T are given for a typical two-burn mission.

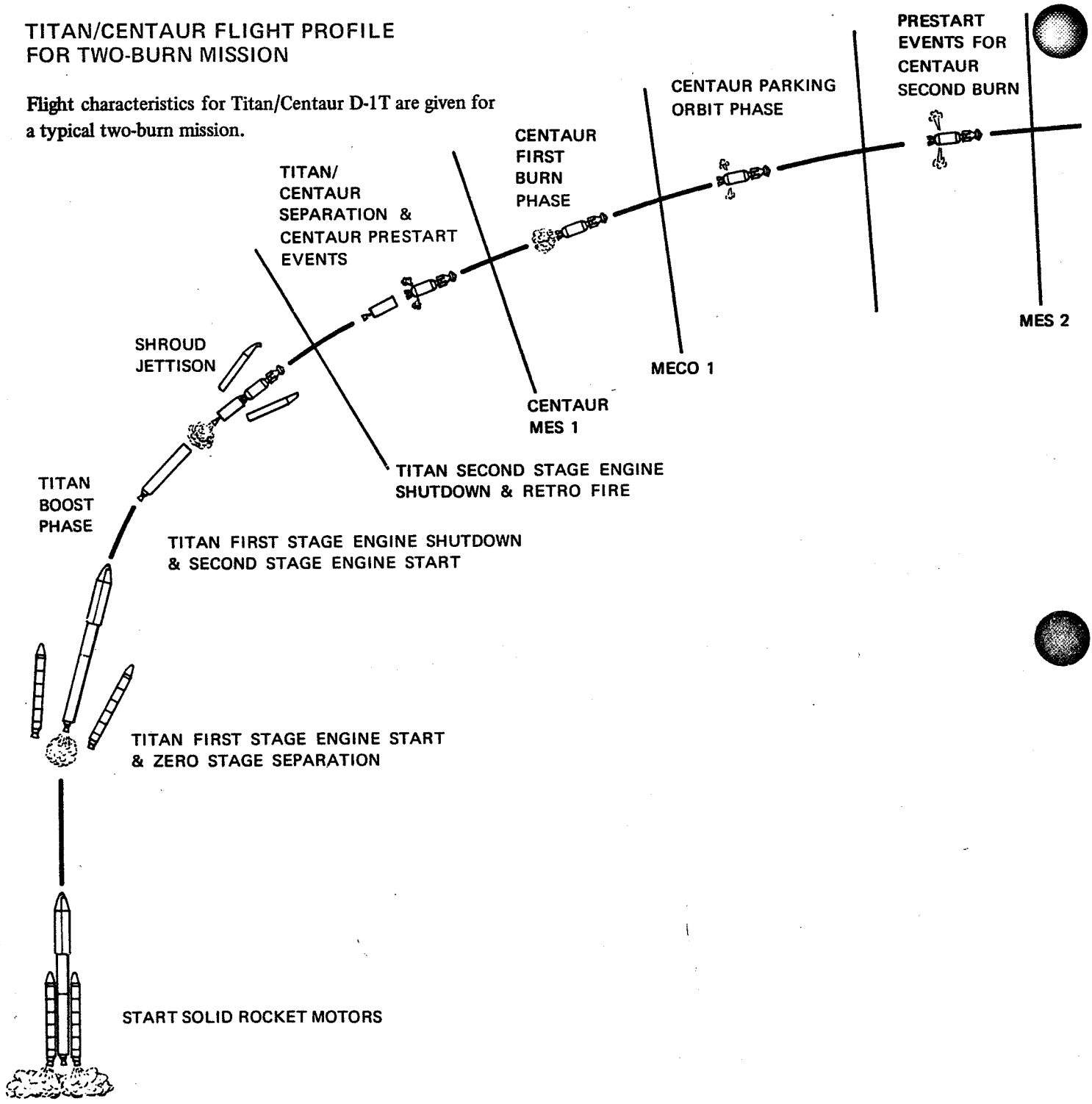

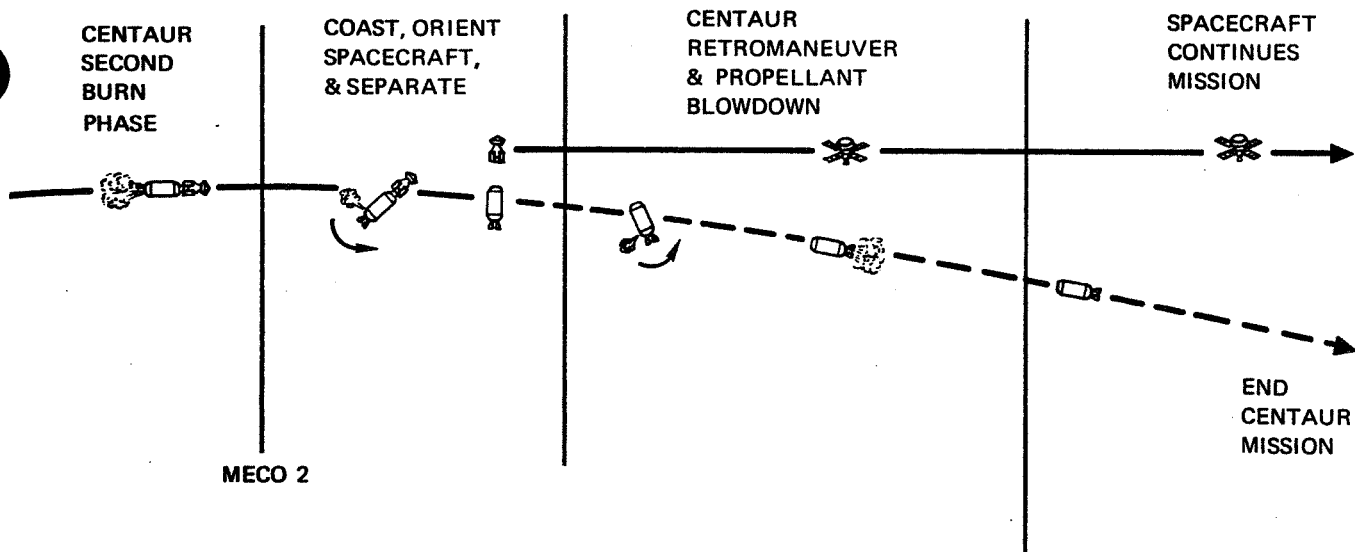

EVENT	APPROXIMATE BASIS	APPROXIMATE TIME FROM LIFTOFF (SEC.)
LIFTOFF (SRMs FIRING, STAGE 0) $T_0$	$T/W = 1.0$	0
START STAGING TIMER, $T_1$	1.5g	111
CORE STAGE 1 IGNITION	$T_1 + 0.129 \text{ SEC.}$	111
JETTISON SRMs, $T_2$	$T_1 + 12 \text{ SEC.}$	122
STAGE 1 SHUTDOWN, $T_3$	PROPELLANT DEPLETION	258
CORE STAGE 2 IGNITION	$T_3 + 0$	258
SEPARATE STAGE 1 & STAGE 2, $T_4$	$T_3 + 0.7$	259
JETTISON SHROUD	$T_4 + 25$	282
STAGE II SHUTDOWN (ACCELERATION LEVEL = $T_5$ )	PROPELLANT DEPLETION	467
SEPARATE TITAN & CENTAUR	$T_5 + 18$	485
MES 1 CENTAUR MAIN ENGINE START, FIRST BURN	$T_5 + 27.5$	495
MECO 1, CENTAUR MAIN ENGINE CUTOFF, FIRST BURN	PARKING ORBIT	628
MES 2, CENTAUR MAIN ENGINE START, SECOND BURN	30 MIN. COAST	2,430
MECO 2, CENTAUR MAIN ENGINE CUTOFF, SECOND BURN	SYNCHRONOUS TRANSFER	
SEPARATION OR COAST FOR THIRD BURN	—————	

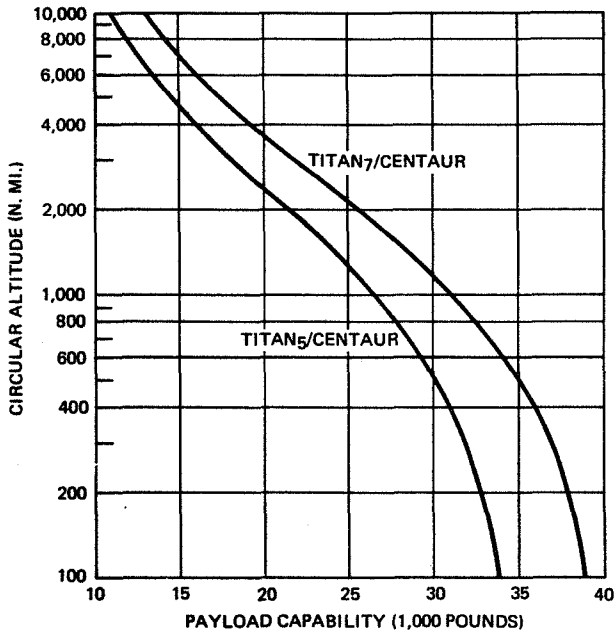

*Titan/Centaur Circular Orbit Payload Capability*

**SYNCHRONOUS ORBITS**

Payload capabilities for synchronous transfer and for synchronous orbits are illustrated. The Centaur second burn occurs at either the first or second nodal crossing. A

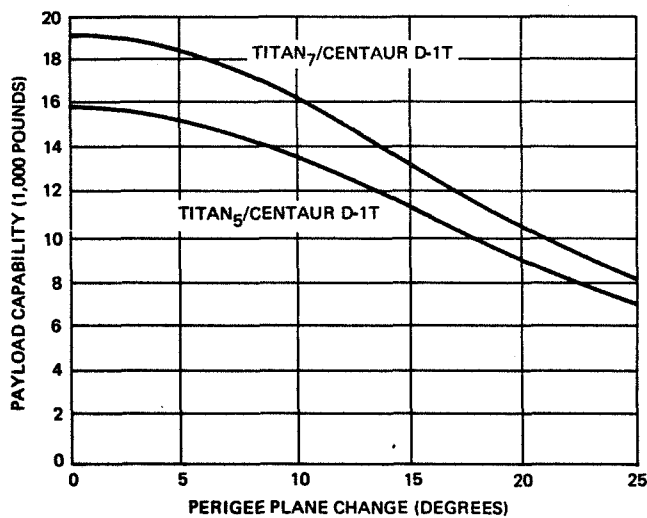

*Titan/Centaur Payload Capability for Synchronous Transfer (100 x 19,300 n.mi.)*

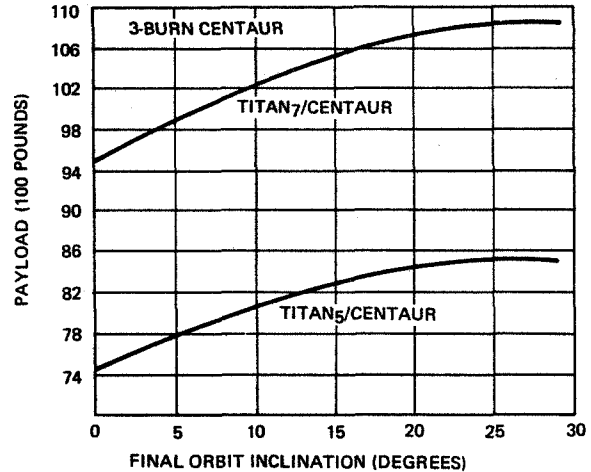

*Titan/Centaur Payload Capability to Synchronous Orbits*

zero perigee plane change conforms to a synchronous transfer orbit inclination of 28.3 degrees.

**PLANETARY OR ESCAPE ORBIT**

Shown on page 4-9 is the payload capability for Titan/Centaur D-1T with and without a TE-364-4, three axes stabilized upper stage.

**CENTAUR FOURTH-BURN CAPABILITY**

Centaur can impart a  $\Delta$  velocity-to-a-second payload after the first payload has been separated. Fourth-burn capability will be demonstrated on the Titan/Centaur proof flight. This could be done either by re-igniting the Centaur main engines or by using the 50-pound hydrogen peroxide reaction control engines (added to Centaur D-1T as a kit). A minimum of 100 seconds of coast before fourth-burn start would be required for reorientation. Payload and velocity capability would consider additional requirements for hydrogen, hydrogen peroxide, and helium.

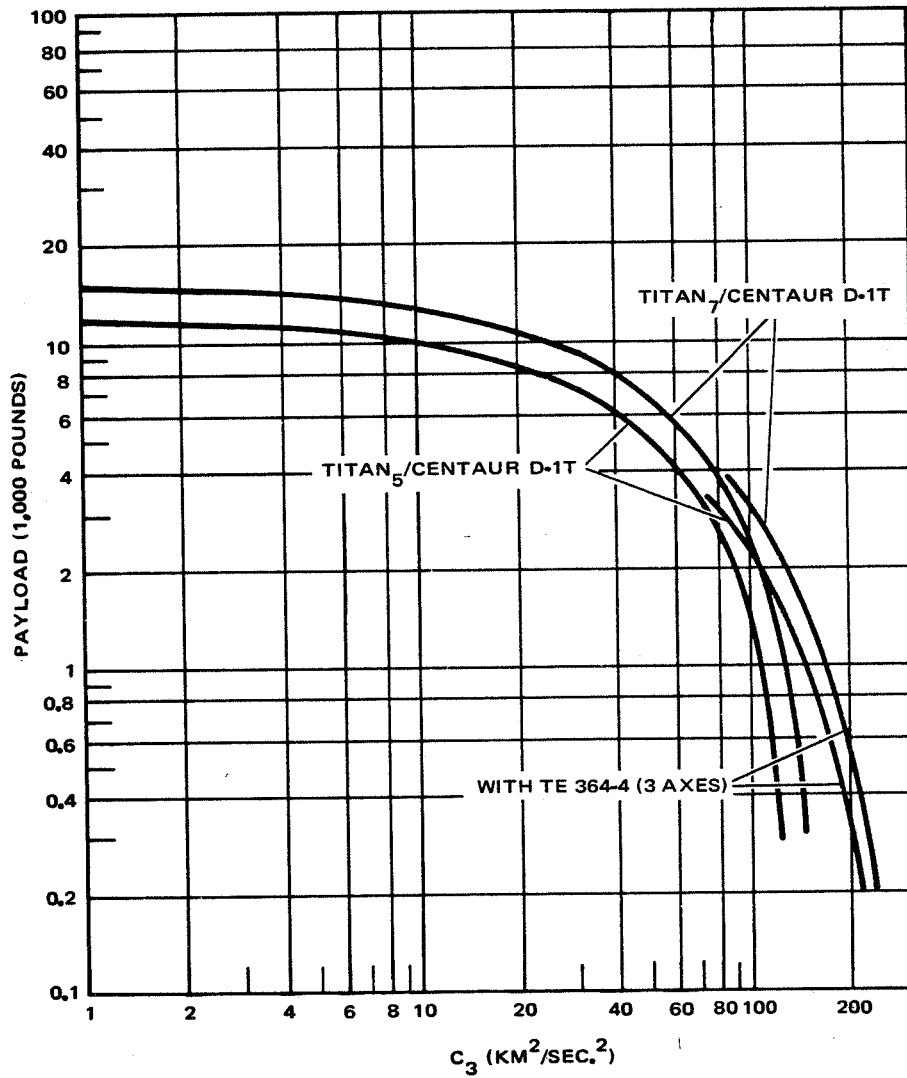

*Titan/Centaur Planetary Payload Capability*

## ACCURACY

Accuracy for the Titan/Centaur D-1T is expected to be equivalent to that achieved by Atlas/Centaur. Please refer to page 3-11 for accuracy estimates.

## CENTAUR STANDARD SHROUD

### SPACECRAFT ENVELOPE

The Centaur Standard Shroud (CSS) provides a very large payload envelope: depending on the configuration, a payload nearly 28 feet long can be accommodated. The allowable payload envelope diameter of 12.5 feet provides clearances for payload and shroud deflections.

### SHROUD DESCRIPTION

The CSS encloses both the Centaur and the payload. The shroud provides environmental protection to the Centaur and spacecraft while they are on the ground and in flight. The cylindrical portion of the shroud around the Centaur and spacecraft is 14 feet in diameter. Total shroud length is 58 feet.

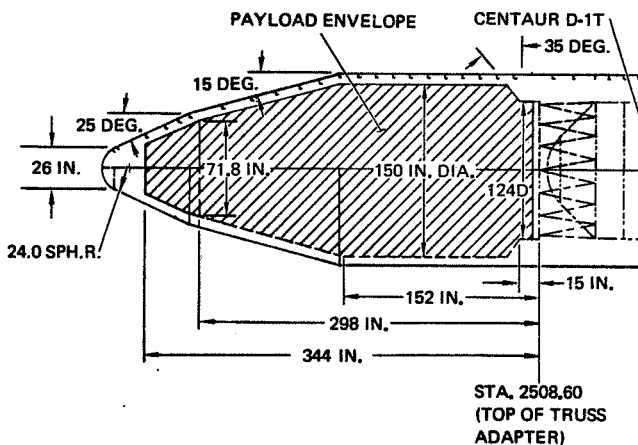

*Spacecraft Envelope with Centaur Standard Shroud*

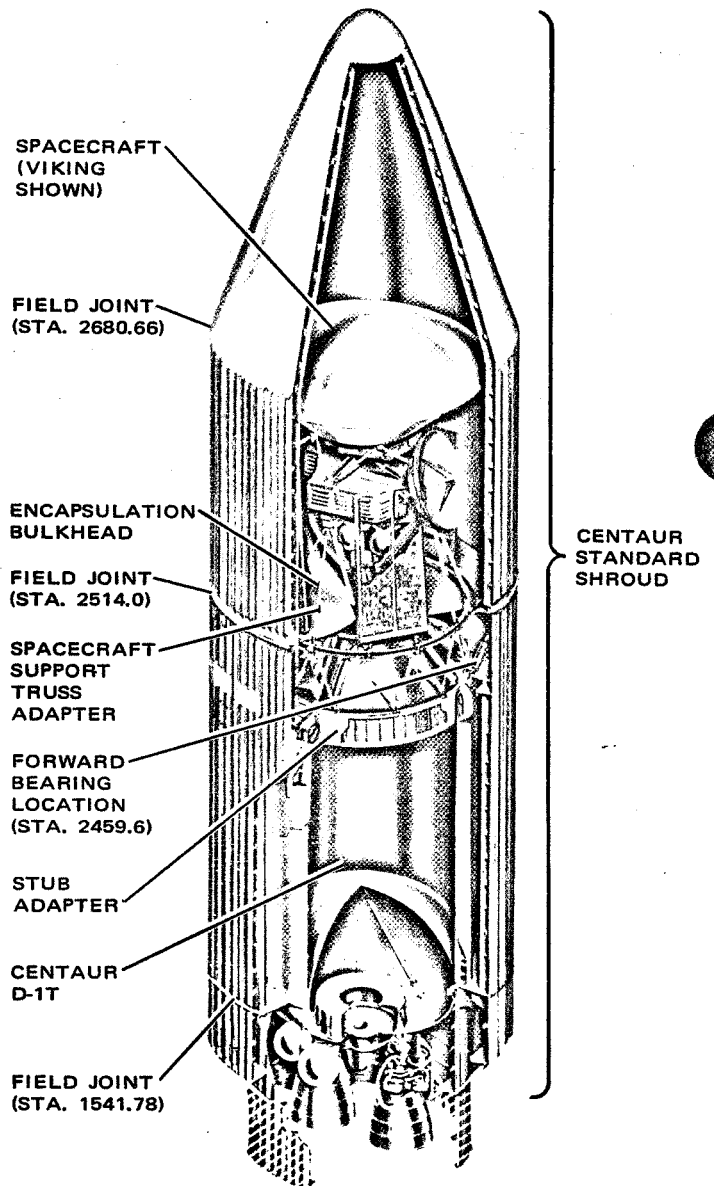

*Shroud with Centaur D-1T and Viking Payload*

The CSS payload section (forward of the field joint at Station 2514.0) is nearly 31 feet long. Its nose cap is made from corrosion-resistant steel; two aluminum radiation shields are attached to the inside. The two conical sections are of magnesium semimonocoque construction. The cylindrical section is of aluminum semimonocoque, corrugated construction.

Attached to the internal rings are one-inch-thick fiberglass blankets. A seal between the shroud field joint and the spacecraft truss adapter allows a clean and thermally controlled environment in the payload area. During ground operation and ascent, the nitrogen is vented into the aft equipment area.

The remaining section extends aft around the Centaur and bolts to the interstage adapter. Construction to the aft field joint at Station 2241.78 is also of corrugated aluminum. Two sections from the field joint to the interstage adapter complete the shroud. The first (from Station 2241.78 to 2209) contains the shroud horizontal separation zip line and separation springs. Its construction is also of corrugated aluminum. It is connected with separation hinges to the final aluminum skin-stringer section, which bolts to the interstage adapter.

A forward bearing reaction system from the shroud to the Centaur stub adapter reduces relative deflections between the shroud and payload during launch and ascent. The reaction path is released after maximum dynamic loading, when the six bearing struts retract to the shroud.

At this same location are a bulkhead and purge seal. The seal separates the helium-purged environment around the Centaur tank from the equipment area environment. The seal is maintained until shroud jettison. An aft seal is located at Station 2241. Shroud insulation in the Centaur tank area is 3.3-inch fiberglass batting.

### SHROUD JETTISON

The two halves of the Centaur Standard Shroud join along a longitudinal split line. Each half also joins to the fixed aft part of the shroud along the circumferential separation plane.

At jettison (about 25 seconds after Titan stage 2 ignition), all split lines are severed by a noncontaminating pyrotechnic system. The aft conical boattail is bolted to the interstage adapter and jettisoned with the Titan stage.

Four compressed springs mounted longitudinally at the base of the fairing force the two halves to separate. Two hinges for each shroud half are attached at the separation plane.

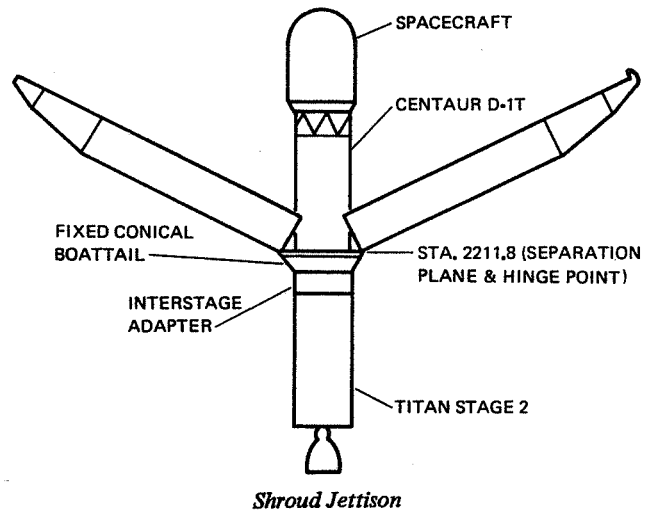

### EXTENSION OF STANDARD SHROUD

The shroud contains a manufacturing joint at Station 2589 in the cylindrical section that provides a convenient point at which future shroud growth can be accommodated. The added weight for a simple extension would be about 84 pounds per foot. For a synchronous equatorial mission or a Viking Mars type mission, a shroud length increase of one foot causes a penalty of about six pounds of payload.

### INTERFACES

#### SPACECRAFT ADAPTER

Large spacecraft attach to a truss type adapter ten feet in diameter and 49 inches high. It consists of 24 struts that culminate in 12 hard points. The struts are aluminum tubes swaged down at the ends to accept a mechanically attached aluminum clevis fitting. The struts bolt to aluminum fittings at the hard points on the Centaur stub adapter.

A circular aluminum inverted channel bolts to the forward fittings, which in turn mates with a mission-peculiar payload adapter.

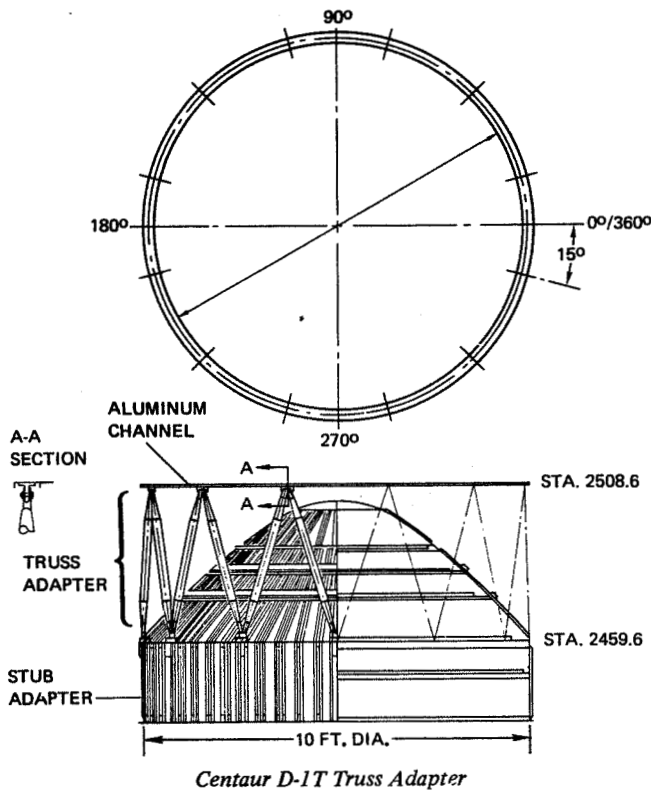

For Viking, Convair Aerospace has designed a five-inch-long payload adapter that attaches to the forward ring of the truss. This spacer contains fittings for the removable GSE used for handling the spacecraft while encapsulated within the forward shroud section.

#### SPACECRAFT WEIGHT AND CG LOCATION

Shown below is data for the payload contractor's preliminary design planning of the spacecraft center-of-gravity location above the truss adapter. Estimated maximum capability of the Centaur D-1T with no structural changes is given with (1) the forward bearing reaction (FBR) located at Station 2459.6 (standard) and (2) with the FBR relocated to the payload center of gravity.

To move the forward bearing reaction, the shroud/FBR interface must be relocated and an interface provided for the payload. For payloads requiring even greater capability, changes to various Centaur structural elements will have to be made, depending on the payload capability needed.

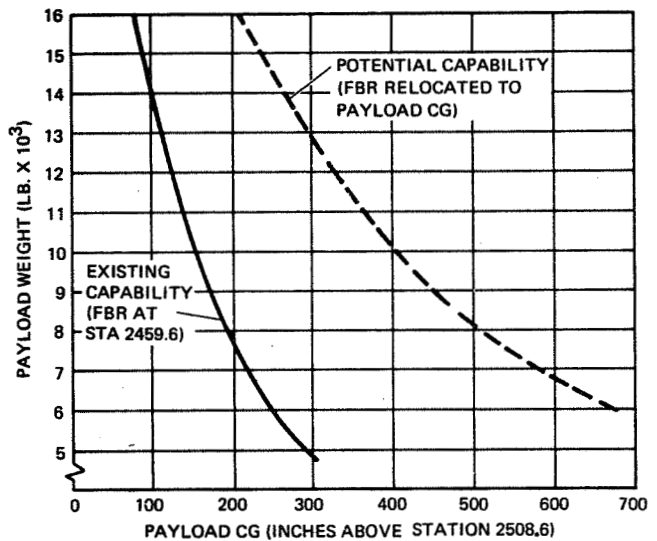

*Spacecraft CG Locations with Centaur D-1T Truss Adapter*

For payloads mounted with an adapter directly to the Centaur D-1T equipment module, the weight and center-of-gravity locations given on page 3-16 are applicable.

#### ELECTRICAL INTERFACES

Essentially all electrical interfaces to the spacecraft are the same for both Centaur D-1A and D-1T. For descriptions of these interfaces, see pages 3-15 through 3-18.

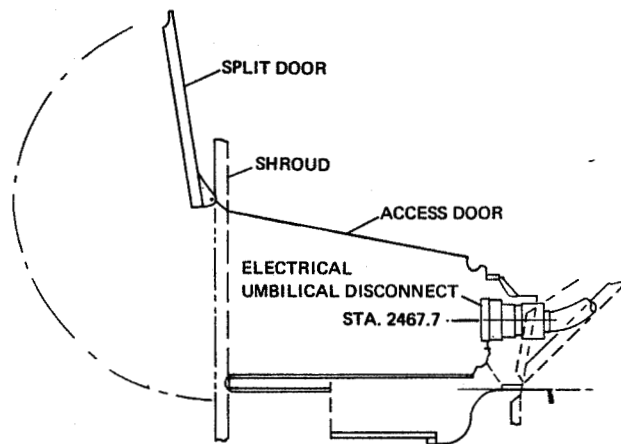

*Umbilical and Split Door in Centaur Standard Shroud*

#### ELECTRICAL UMBILICAL

One airborne difference is related to the passage of the electrical umbilicals through the shroud. For Centaur D-1T, these umbilicals connect through the shroud to the



umbilical mast at the Complex 41. After riseoff the airborne connectors are protected from the airstream by doors in the shroud.

The spacecraft J3 umbilical is released before liftoff (T minus 4 seconds). The T minus 4 lanyard system, operated by an actuator, consists of a main lanyard branching into three intermediate lanyards. Each of the intermediate lanyards will be connected to both the primary and backup release attached to the J3 connector.

The spacecraft J4 umbilical is attached to a separate lanyard system, which releases at liftoff. This system does not use an actuator.

## ENVIRONMENT

Recommended spacecraft flight acceptance levels for vibration, shock, and acoustic environments are shown below. Levels given are preliminary since analyses are still in progress. Qualification test levels are considered to be at least 50% higher than these flight acceptance test levels.

### PAYLOAD LIMIT LOAD FACTORS

Static load factors for Titan/Centaur differ markedly from Atlas/Centaur during the boost phase. Titan/Centaur axial load factors for a two-burn Centaur mission are shown.

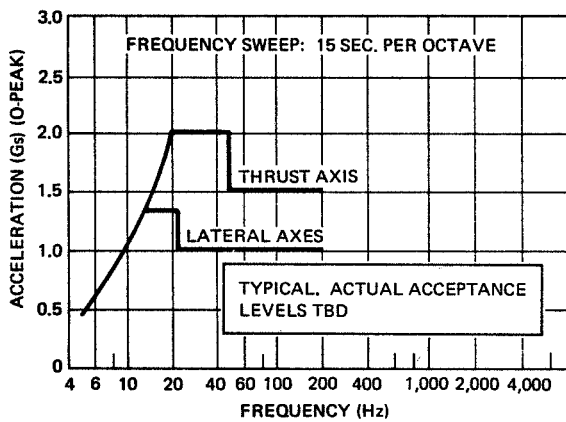

Recommended Sinusoidal Vibration Environment (Sweep)

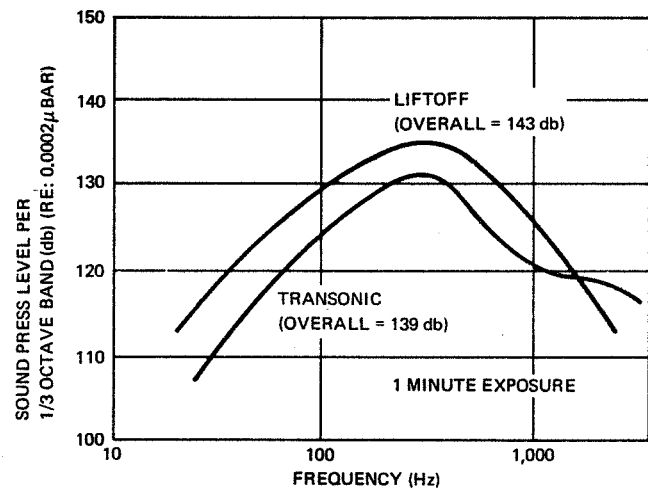

Recommended Acoustic Environment

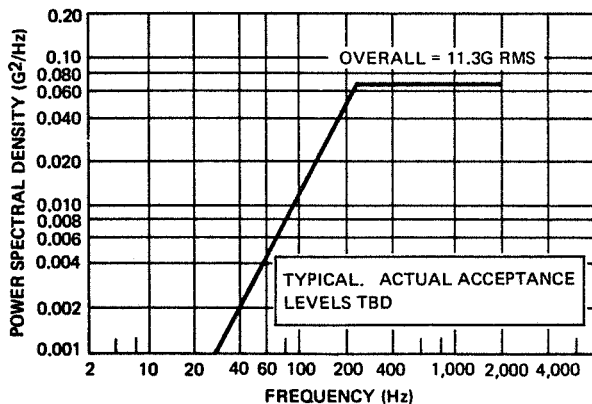

Recommended Random Vibration Spectrum

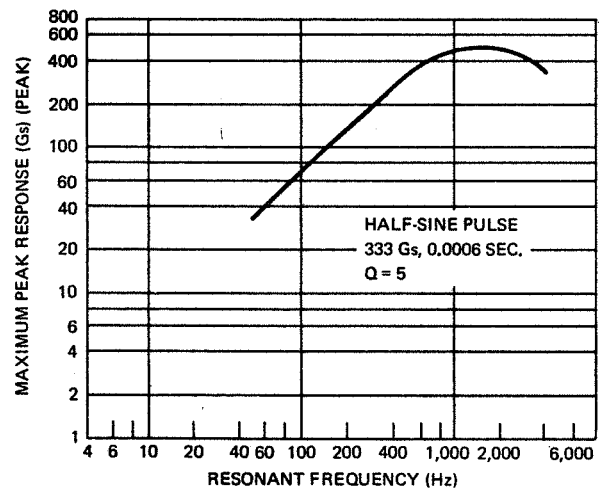

Recommended Shock Environment

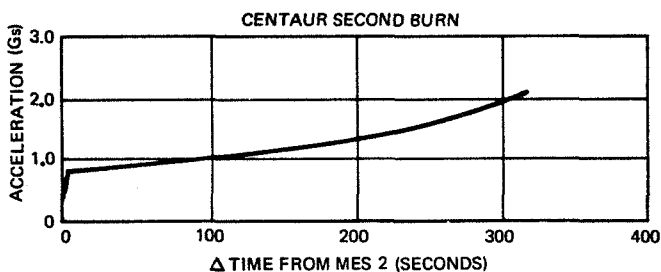
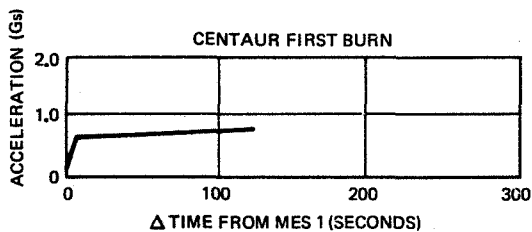
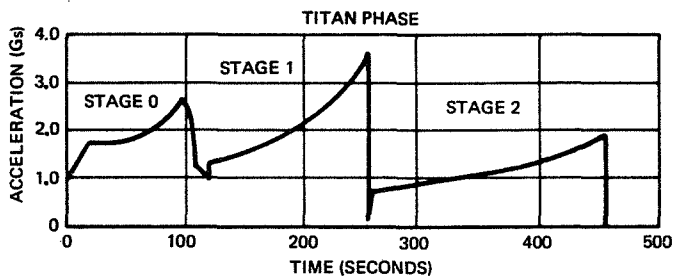

*Expected Axial Load Factors for Titan/Centaur Launch (8,000-Pound Spacecraft)*

**THERMAL**

**PRELAUNCH** – The thermal environment of the spacecraft is carefully controlled during all prelaunch phases. Encapsulated payloads are generally mated to Centaur D-1T in the universal environment shelter (UES) contained in the Complex 41 mobile service tower (MST). The UES allows either an ambient or a temperature-humidity controlled environment. The MST is removed before launch, and air conditioning is provided to the payload compartment through the umbilical from the umbilical tower. Please see page 4-17 for air-conditioning capabilities.

**ASCENT PHASE** – The inside of the Titan/Centaur shroud covering the payload is insulated and shielded to limit the inner surface temperature to a maximum of 135 degrees F. The fairing is jettisoned at a time determined by the three-sigma maximum allowable free molecular aerodynamic heating on the payload. Typical payload

maximum aerodynamic heating constraint is 650 Btu/hr.ft.<sup>2</sup>. This permits shroud jettison during early portions of Titan stage 2 operation at altitudes greater than 375,000 feet.

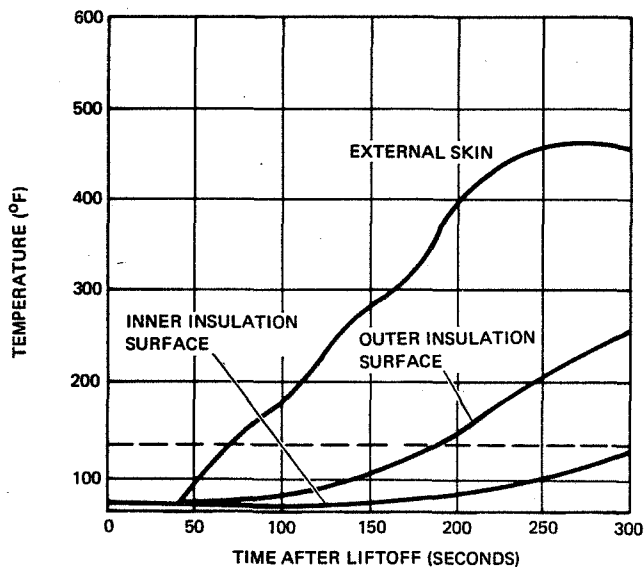

*Centaur Standard Shroud Temperatures*

**SPACE** – The comments given in the Atlas/Centaur discussion (page 3-21) apply equally to Titan/Centaur.

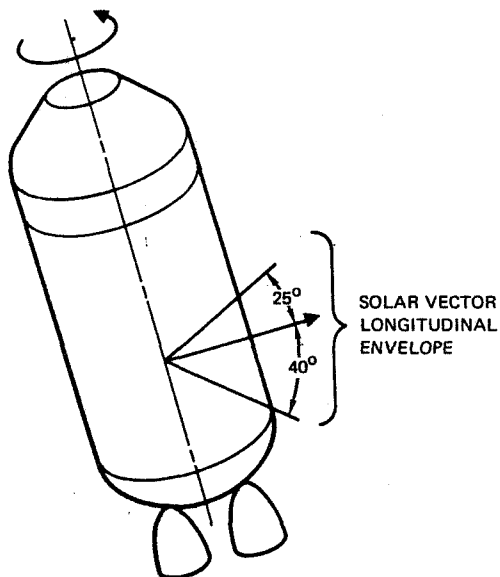

*Centaur Rolls for Thermal Control*

Centaur D-1T, with its three-burn capability, will inject spacecraft into synchronous equatorial orbits. During the five-hour coast to synchronous apogee, Centaur will maintain attitude control. Centaur can perform maneuvers as required to aid the spacecraft in maintaining a satisfactory thermal environment.

A programmed series of vehicle rolls will direct the sides of the Centaur and spacecraft alternately toward and away from the sun. The most easily provided maneuver places the sun nearly broadside to the vehicle/payload longitudinal axis. Centaur rolls 180 degrees around its longitudinal axis every 30 minutes or less.

**PAYLOAD COMPARTMENT INTERNAL PRESSURE** — The payload compartment internal pressures generally follow atmospheric pressure. The pressure lag is governed by the design vent flow path restrictions between the payload compartment and the aerodynamic flow outside the shroud vent holes. A deviation from this trend occurs at transonic speeds when the internal pressure envelope tends to drop relative to the atmospheric pressure. This occurs at flight times of 40 to 55 seconds.

The internal pressure profile may be somewhat altered by adjusting the venting capacity from the payload compartment as long as structural pressure loading constraints of the shroud and other forward compartment structures are not violated.

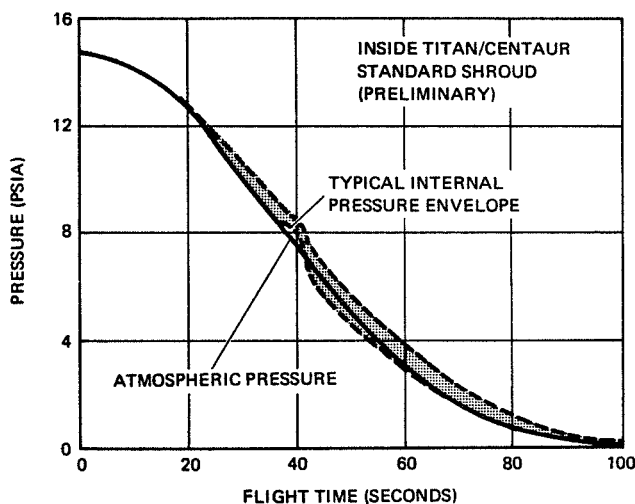

*Shroud Internal Pressure*

## LAUNCH FACILITIES

Titan/Centaur is launched from Complex 41 at the Kennedy Space Center. The pad is part of the Integrate-Transfer-Launch facility (ITL). Centaur is mated to the Titan liquid propellant core structure in the Vertical Integration Building (VIB).

The assembled liquid stages are transported by rail to the Solid Motor Assembly Building (SMAB). Here the two Titan solid motors are attached. The entire launch vehicle then is moved upright to the launch site. Aerospace ground equipment (AGE) in rail-mounted vans accompanies the launch vehicle to Complex 41.

The spacecraft encapsulated in the Centaur shroud is mated at the launch pad. The launch schedule permits mating the encapsulated spacecraft early for participation in the terminal countdown demonstration (TCD). Following the TCD, the spacecraft is returned to the encapsulation area, where the shroud is opened and the spacecraft receives final flight preparations.

## VERTICAL INTEGRATION BUILDING

Facilities and checkout equipment are available in the VIB for the spacecraft contractor. Included are electric power (60 and 40 Hz, 208/120 volts; and 28 volts d-c), air conditioning, supplies of inert gases, and ducting.

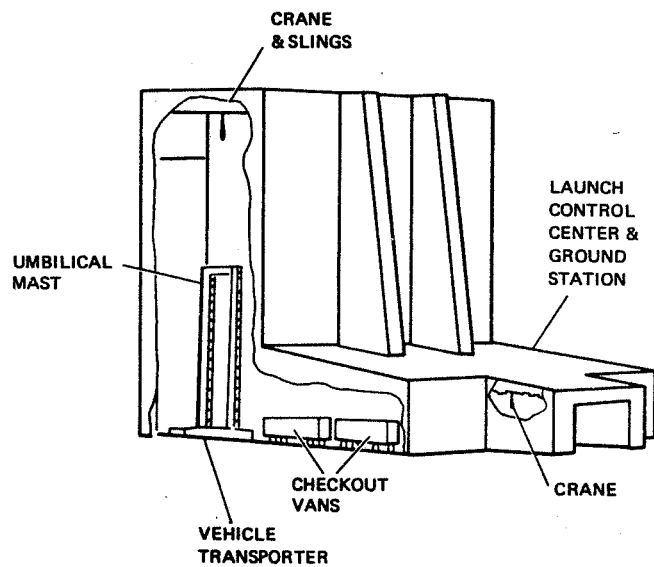

*Vertical Integration Building*

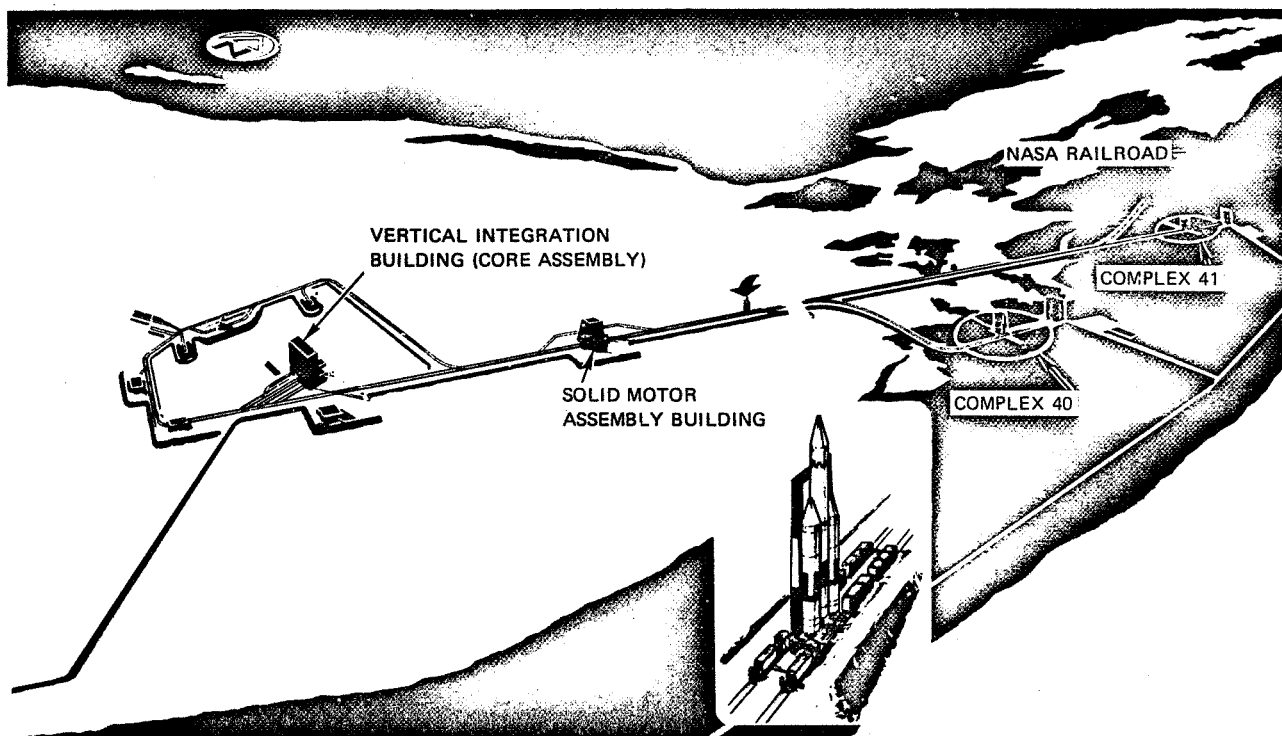

*Integrate-Transfer-Launch Facility for Titan/Centaur*

360-degree access to the spacecraft is available from adjustable-height platforms. The bridge crane has a hook height of 180 feet and a capacity of 20 tons.

Also in the VIB, above the low bay area, is the launch and checkout control center. From here launch operations and countdowns are conducted.

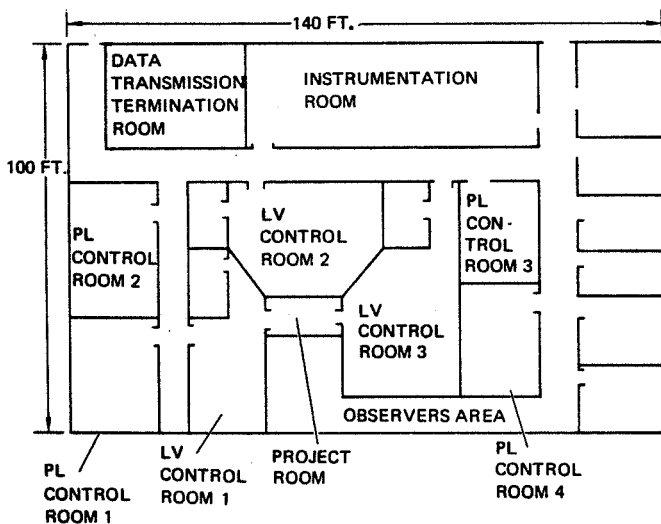

*Launch and Checkout Control Center*

#### LAUNCH COMPLEX 41

At the launch complex, the vehicle is readied for launch next to the permanent umbilical tower. The umbilical mast, permanently mounted on the transporter, accompanies the vehicle from the VIB. The mobile service tower surrounds the launch vehicle until it is moved away shortly before launch. The MST passes over the concrete AGE building as it is moved away.

#### UNIVERSAL ENVIRONMENT SHELTER

Payload mating and checkout take place in the Universal Environment Shelter (UES), which is inside the mobile service tower.

Within the 75-foot-high UES are five platforms, located at about ten-foot intervals from the floor. The platforms totally surround the spacecraft, and each measures 39 by 25 feet. The UES makes available air conditioning, ducting, and power, and contains a five-ton capacity bridge crane for positioning. The MST 50-ton-capacity bridge crane is used for mating the shroud and payload to Centaur.

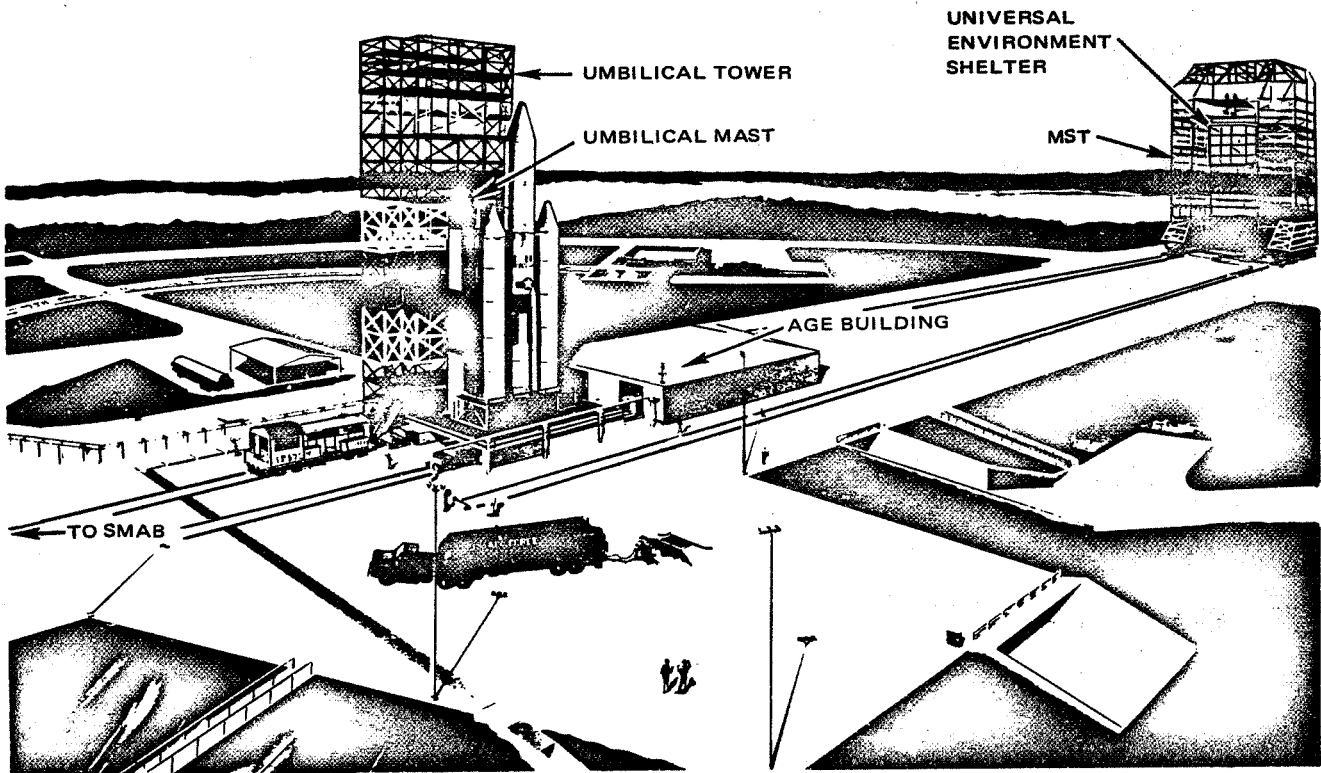

Launch Complex 41

### UMBILICALS

**SPACECRAFT AIR CONDITIONING FOR THE D-1T** – The same airborne disconnect system is used for the Centaur D-1A and D-1T. The inlet door for the D-1T is on the standard shroud just below the cone cylinder joint at Station 2656.55. The ground duct connects to the LC41 umbilical mast.

At liftoff, after the disconnect inflatable seal pressure is removed, the ground duct is retracted by a bungee. Another lanyard acts as a backup retraction system. Internal ducting is provided to suit mission-peculiar requirements.

The air-conditioning system provides either air or gaseous nitrogen (used during Centaur tanking). These are available as follows.

- Volume: 70 to 200 lb./min.
- Pressure: 0 to 29 in. of H<sub>2</sub>O (at 100 lb./min. flow rate)
- Temperature: (at inlet to payload compartment) 50 to 100 deg. F (± 2 deg. F)

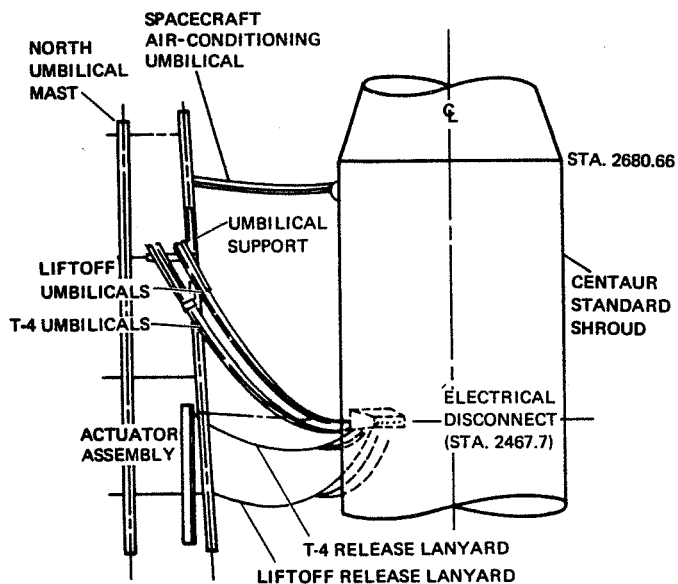

Complex 41 Forward Umbilicals to Centaur and Spacecraft

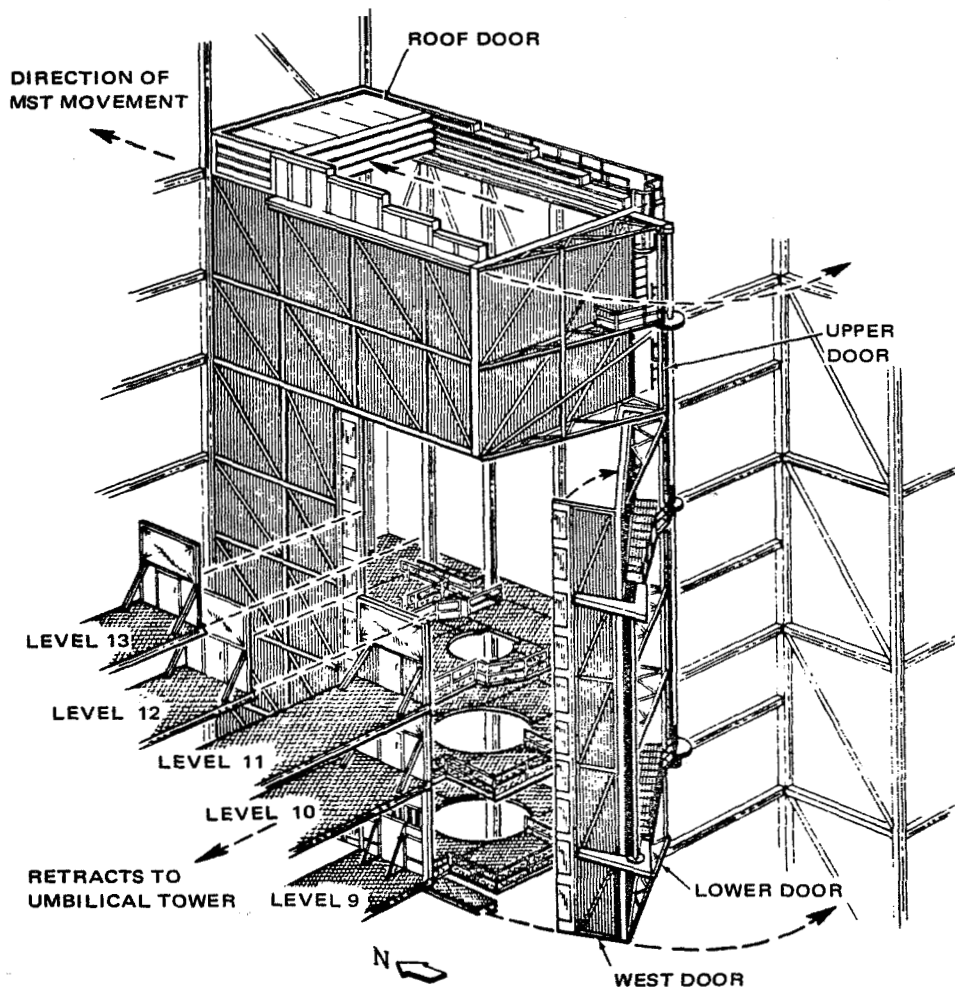

*Universal Environment Shelter*

**Humidity:** 40 deg. dewpoint maximum; significantly lower with GN<sub>2</sub> flow.  
**Filtration:** HEPA filter

These lines connect to the umbilical mast. Just before liftoff, they are severed at the shroud, and the umbilical falls away. The lines inside the shroud are retracted to the spacecraft for flight.

**OTHER FLUID INTERFACES** — For Viking, gas and water lines connect to the spacecraft through the shroud just below the cone/cylinder joint, near the fairing split line (preliminary). One set of lines contains chilled sterile water to cool the radioisotope thermal-electric generator (RTG). Another set provides gaseous nitrogen to maintain pressure inside the spacecraft.

#### PROCUREMENT

Nominal procurement time for Centaur D-1T is 22 months from contract go-ahead to vehicle acceptance (DD250). Nominal launch date is 25 months from go-ahead. Procurement lead time for the Titan III booster is 24 months from go-ahead to launch.



# PAYLOAD/LAUNCH VEHICLE INTEGRATION

## ORGANIZATIONS AND RESPONSIBILITIES

Clear communication between the spacecraft and launch vehicle agencies is vital to mission success. Procedures and interfaces are established to allow clear areas of responsibility and authority.

## LAUNCH VEHICLE RESPONSIBILITIES

The NASA Lewis Research Center is responsible for Centaur program management. Relationships between NASA and the United States Air Force for Air Force use of Centaurs are now being formulated.

The Convair Aerospace Division of General Dynamics is primary contractor for design, integration, checkout, and launch of Centaur. This work is done chiefly at the Kearny Mesa plant of the division's San Diego operation. Associate contractors are Pratt & Whitney (main engines), Honeywell (inertial measurement unit), and Teledyne Systems (digital computer unit).

As the spacecraft-to-launch vehicle integrating contractor, Convair Aerospace is responsible for payload integration, electromagnetic compatibility and guidance

system integration, mission analysis, software design, launch vehicle range support, and range safety documentation. For Atlas/Centaur launches, Convair Aerospace has produced all launch vehicle-related software. For Viking, Convair Aerospace has prime responsibility for launch vehicle ascent trajectory, performance analysis, targeting, guidance analysis, and range safety analysis.

Convair Aerospace is also responsible for spacecraft encapsulation. This task includes ground transport to the launch site, raising the spacecraft to the proper level, and mating the spacecraft and fairing to the booster.

## INDIVIDUAL MISSION AND VEHICLE REQUIREMENTS

Each spacecraft and mission have their own unique requirements. Interested Centaur users are encouraged to discuss their particular needs with Convair Aerospace predesign engineers. Centaur and its related hardware and software have a great deal of flexibility and adaptability that permit tailoring to special applications.

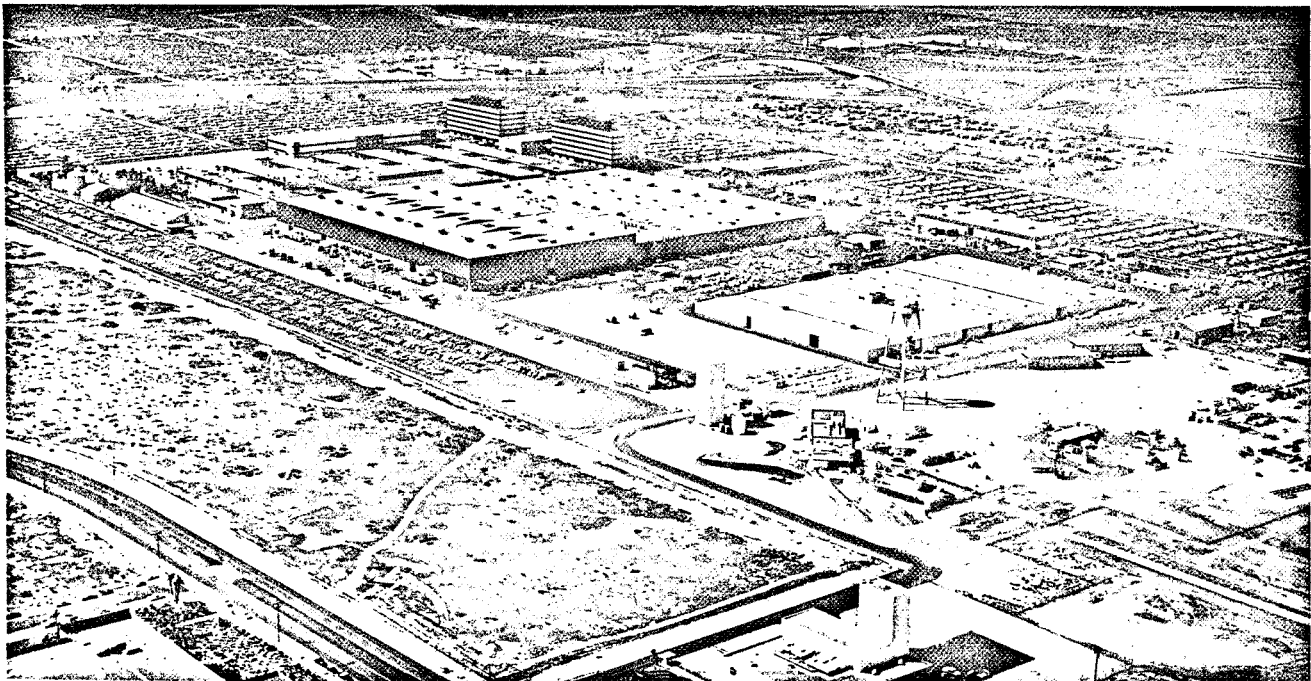

*Kearny Mesa Plant, San Diego Operation of Convair Aerospace*



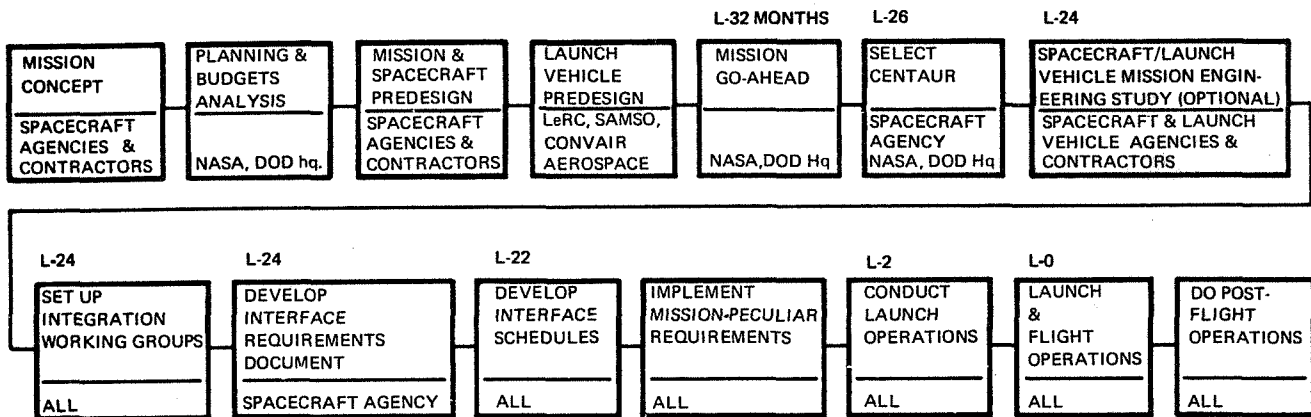

*Steps from Mission Concept to Successful Centaur Launch*

The user also is encouraged to contact Convair Aerospace to verify that he has the latest information about Convair vehicles. The history of Atlas and Centaur is a series of upgrades in capability, flexibility, and reliability. Such information might include:

- Hardware status and plans
- Launch and launch complex schedules
- Hardware production schedules and costs

**INTERFACE GROUPS**

In all phases of a new mission, from go-ahead to launch, interface activities of contractors and agencies are coordinated by specialized working groups.

These groups, which include the spacecraft contractor as an active participant, work out planning schedules, monitor progress, and ensure that interfacing technical or management tasks are done properly and on time.

Information between the agencies and contractors concerned is exchanged in meetings of the groups, by the minutes and action items of the meetings, and by control drawings and other documentation.

The major groups for spacecraft and launch vehicles are: Project Launch Vehicle/Spacecraft Interface Working Group (IFWG); Performance, Trajectory, and Guidance Working Group (PT&G); and Launch Operations Working Group (LOWG).

These groups often have subgroups that are assigned to specific areas. Additional working or steering groups

primarily represent agencies, and spacecraft and range/tracking network contractors.

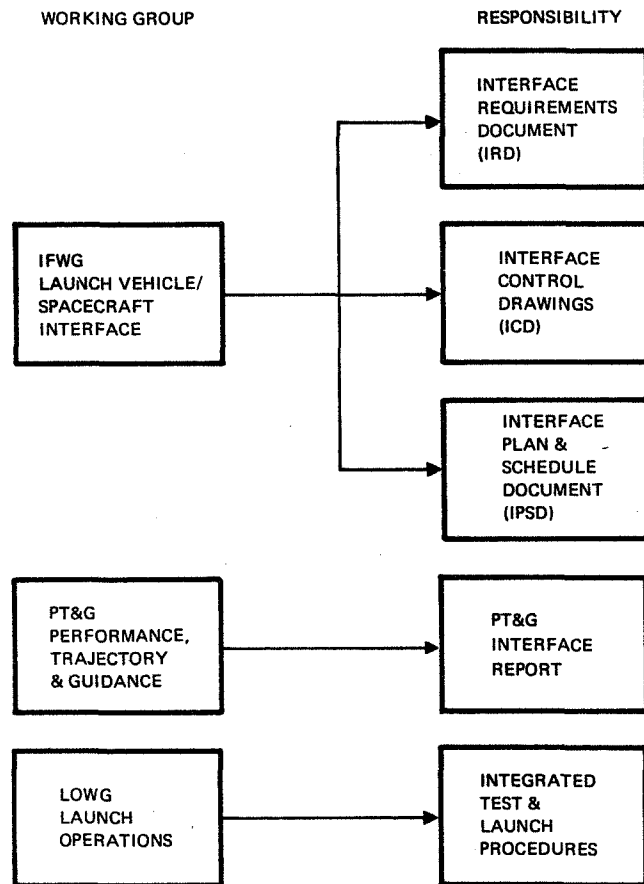

*Integration Documentation Responsibilities*

## INTERFACE DOCUMENTATION

Major documents used for planning and monitoring interface activities are as follows:

**INTERFACE REQUIREMENTS DOCUMENT** – The IRD is the source of technical and functional requirements imposed by the spacecraft or mission on the launch vehicle system. Information given typically will concern thermal limitations, power requirements, orbit requirements, or

interface details of the spacecraft. It does not include schedules, test procedures, AGE designs, etc. to achieve the events. The IRD is created by the spacecraft agency, with the launch vehicle agency or contractors providing support as required.

**INTERFACE CONTROL DRAWINGS** – The ICD control the interface design between the launch vehicle and spacecraft. These drawings describe in detail the mechanical, electrical, and AGE hardware interfaces as they

### *Integrated Factory-to-Launch Activities*

#### FACTORY TESTS

TYPICAL TEST	PURPOSE	METHOD
MATCHMATE	TO EVALUATE MECHANICAL COMPATIBILITY OF SPACECRAFT & LAUNCH VEHICLE INCLUDING FAIRING CLEARANCES	MATE SPACECRAFT (FLIGHT OR MODEL) & ADAPTER TO CENTAUR EQUIPMENT MODULE
RF TEST	TO ENSURE LAUNCH VEHICLE & SPACECRAFT RF SYSTEMS ARE COMPATIBLE	SIMULTANEOUS OPERATION OF TELEMETRY & TRACKING SYSTEMS WITH ANTENNAS
PYROTECHNIC DESIGN VERIFICATION	TO VERIFY LAUNCH VEHICLE PYROTECHNICS FOR SPACECRAFT SEPARATION ARE COMPATIBLE WITH SPACECRAFT	SQUIB SIMULATORS ON SPACECRAFT PYROTECHNIC HARNESS
FLIGHT ADAPTER COMPATIBILITY	TO DEMONSTRATE ELECTRICAL & MECHANICAL COMPATIBILITY OF FLIGHT ADAPTER	MATE ADAPTER TO CENTAUR EQUIPMENT MODULE

#### LAUNCH PAD TESTS

TYPICAL TEST	PURPOSE	METHOD
TERMINAL COUNTDOWN DEMONSTRATION (TCD)	TO VERIFY PROPELLANT LOADING CAPABILITY & THAT LAUNCH VEHICLE OR SPACECRAFT RF SYSTEMS ARE NOT ADVERSELY AFFECTED BY CRYOGENIC TANKING	TANK & SIMULATE PRELAUNCH ACTIVITIES. MONITOR SPACECRAFT FUNCTIONS TO ENSURE THAT ALL SYSTEMS PERFORM PROPERLY. TOWER IS REMOVED
FLIGHT EVENTS DEMONSTRATION (FED)	TO VERIFY THAT COMBINED SYSTEMS FUNCTION PROPERLY IN CONDITIONS CLOSELY SIMULATING FLIGHT	SPACECRAFT ELECTRICAL UMBILICALS REMOVED & SPACECRAFT RF SYSTEMS OPERATED ON INTERNAL POWER THROUGH SIMULATED SEPARATION & CENTAUR RETROMANEUVER. FAIRING JETTISON & SPACECRAFT SEPARATION SIGNALS SENT & MONITORED BUT NO ACTUAL RELEASE OCCURS
COMPOSITE ELECTRICAL READINESS TEST (CERT)	TO VERIFY LAUNCH READINESS OF ATLAS & CENTAUR ELECTRICAL & RF SYSTEMS	LAUNCH VEHICLE CHECKED OUT IN SYSTEMS LEVEL WITH SPACECRAFT IN GENERAL ENCAPSULATED. SPACECRAFT CHECKOUT MAY BE INTEGRATED

The tests above are standard launch vehicle tests. The spacecraft contractor is encouraged to participate in them, since they offer opportunities for integrated testing. Electromechanical interference (EMI) and radio frequency interference (RFI) tests can often be efficiently conducted during these tests.

evolve during the design and development phases of the project. The drawings will specify all critical characteristics of mechanical, electrical, hydraulic, pneumatic, optical, RF, material type, spacecraft/shroud static and dynamic envelopes, and weight requirements at the interface. These are thus integrated and coordinated documents.

other formal interface activities required as the program evolves. For the Viking program, Convair Aerospace created and maintains the IPSD. Examples of IPSD events are hardware exchanges, special interface tests, matchmates, combined systems tests, end-to-end calibration tests, and interface document generation. (See table on page 5-3.)

**INTERFACE PLAN AND SCHEDULE DOCUMENT –**  
 The IPSD is the complementary document or answer to the interface requirements document. It establishes the plan and schedule information for the various interface activities identified in the IRD. It also provides this information for

**PERFORMANCE, TRAJECTORY, AND GUIDANCE INTERFACE AGREEMENT AND SCHEDULE –** This document defines the project interface in the performance, trajectory, and guidance areas. It is also intended to ensure that all necessary interface tasks are understood, properly

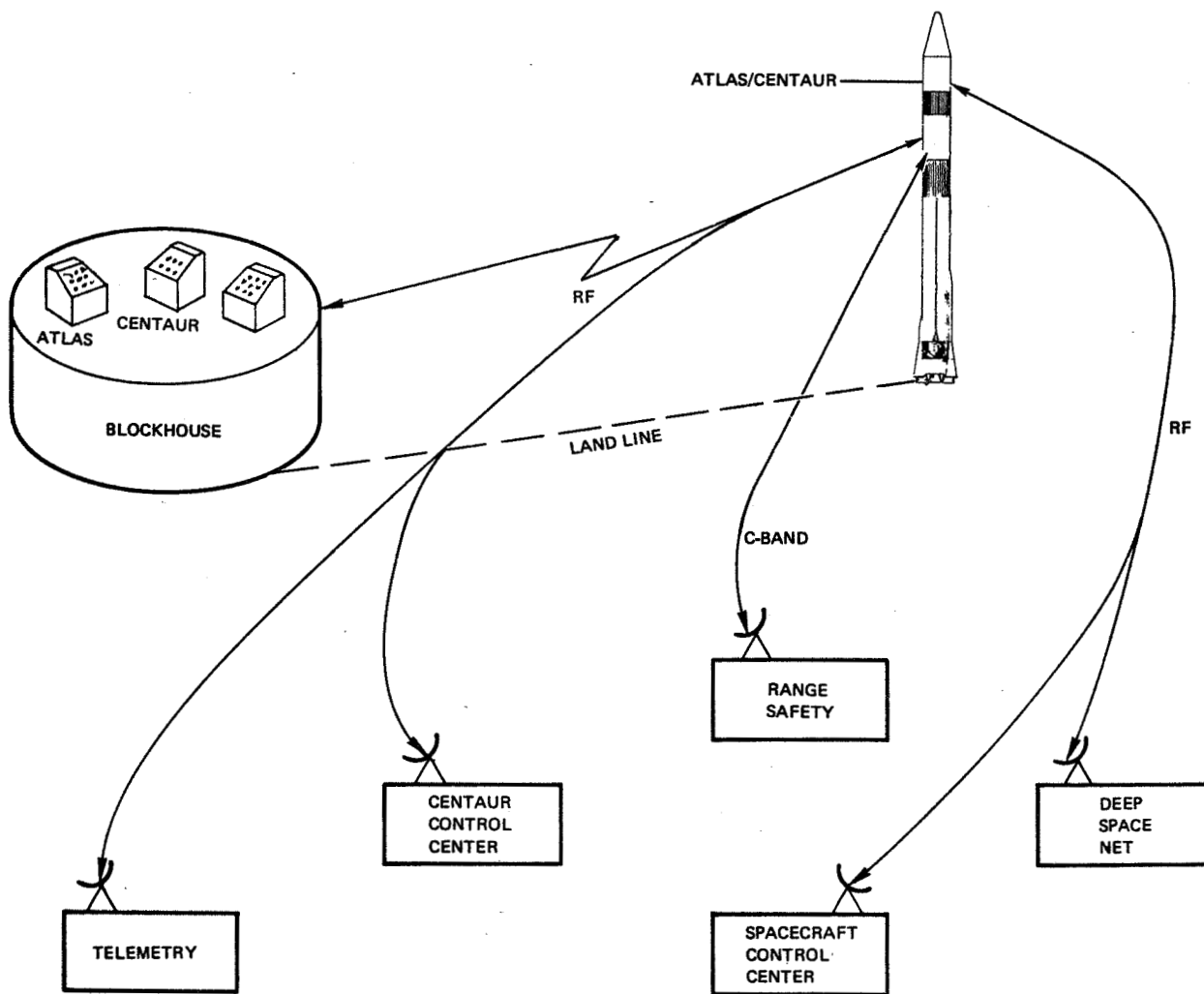

*Facilities Involved in Typical Composite Electrical Readiness Test*

scheduled, and completed on time to support project needs. Convair Aerospace, under the direction of the Lewis Research Center, has responsibility for creating and keeping up this document for most programs.

**SPACECRAFT/LAUNCH VEHICLE INTEGRATED TEST AND LAUNCH PROCEDURES** – Purpose of this document is to coordinate prelaunch system checkout calibrations, or launch tests on countdown sequences. Convair Aerospace prepares this report under the direction of the Lewis Research Center.

### FACTORY-TO-LAUNCH PROCEDURES

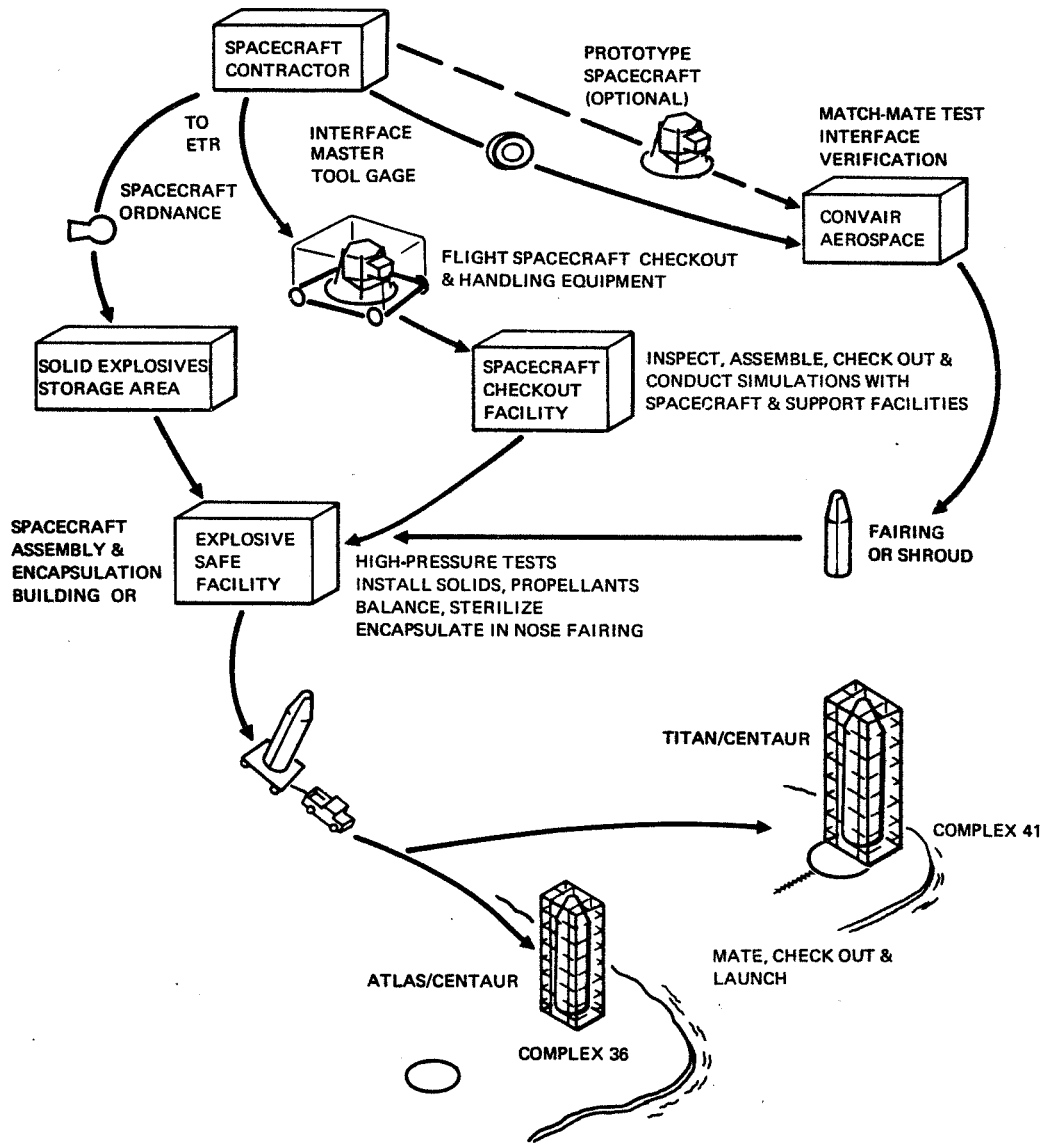

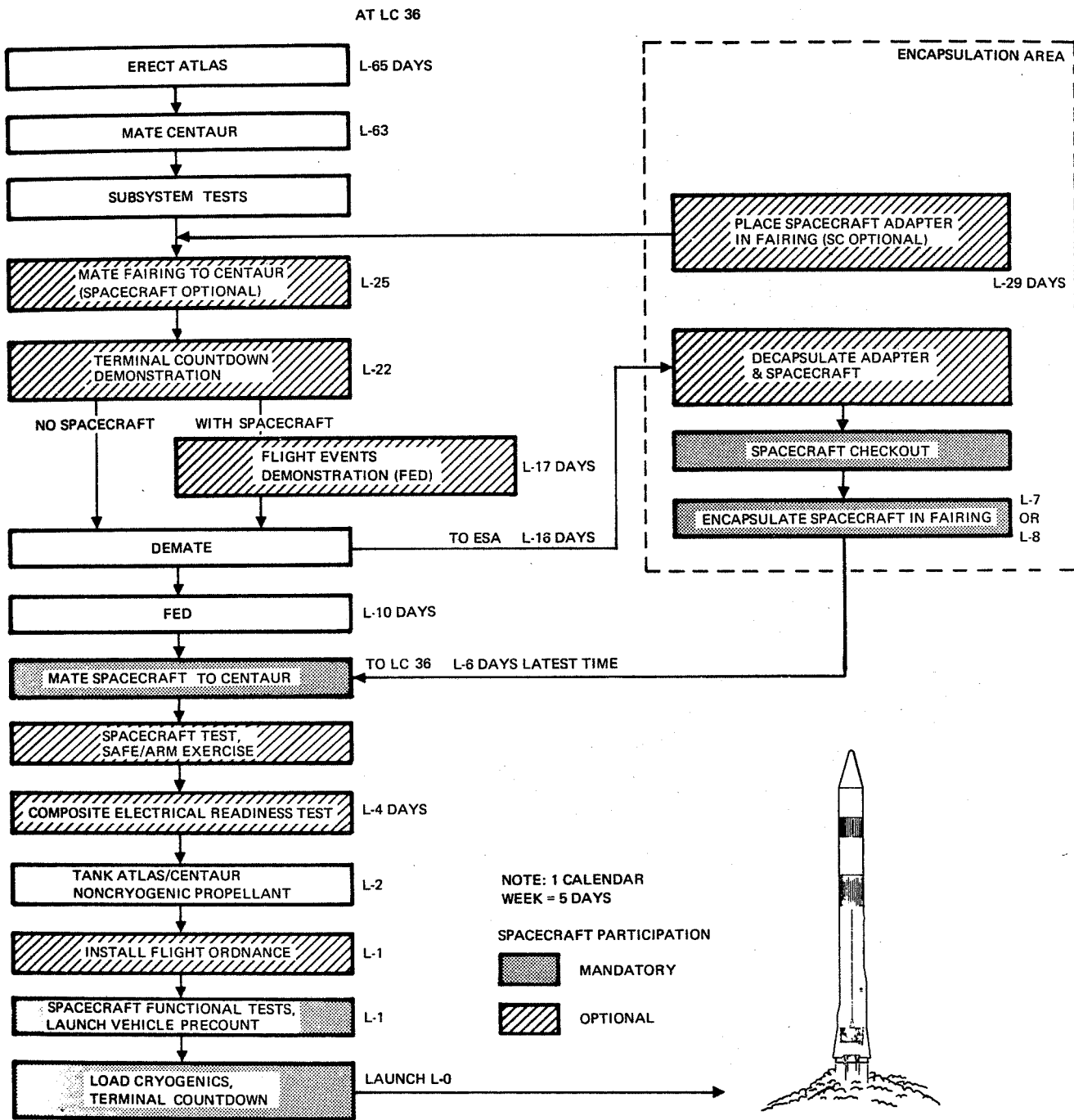

*Atlas/Centaur Checkout and Launch Operations*

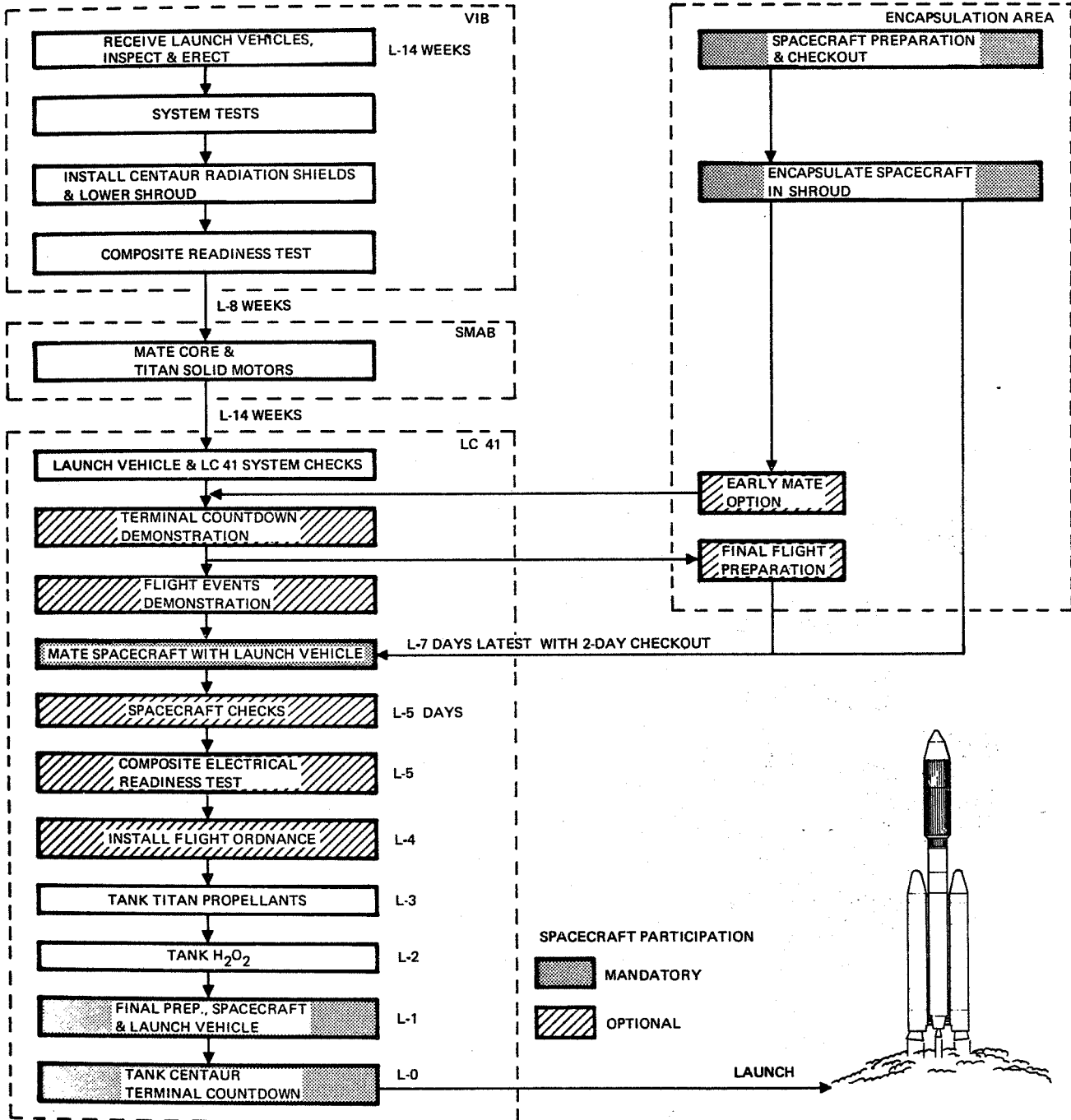

Titan/Centaur Checkout and Launch Operations

**SPACECRAFT ETR FACILITIES**

Facility descriptions chiefly are condensed from the Handbook of Unmanned Spacecraft Operations at ETR.

**SPACECRAFT CHECKOUT FACILITIES**

The NASA Unmanned Launch Operations Group assigns a spacecraft project to one of four spacecraft checkout facilities (SCF) buildings – AO, AE, AM, or hangar S. They are located in the Cape Kennedy Air Force Station industrial area. The SCF has laboratories and offices for the use of spacecraft manufacturers. Spacecraft-peculiar checkout or handling equipment is provided by the spacecraft contractor.

Building AO is the largest of the four SCF buildings. The systems test area provides a clean and thermally controlled environment. Typical operations there are performance verification tests, subsystem tests, and calibrations. The SCF serves as a master control station for tests involving the explosive safe facility (ESF) and launch pad. Wideband data circuits are available for transmission and receipt of inflight spacecraft telemetry data from worldwide tracking stations.

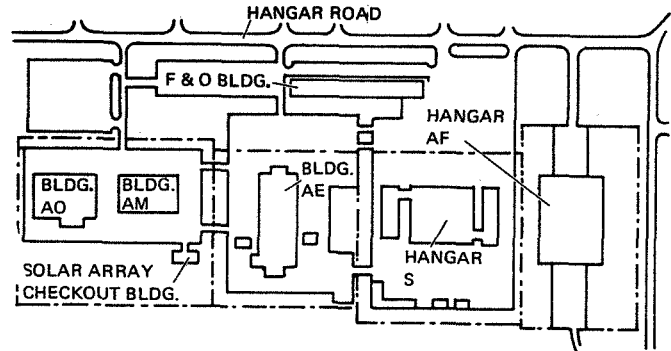

*Spacecraft Checkout Facility Locations*

Maximum bridge crane hook heights and capacities for the four buildings are:

**BRIDGE CRANE HOOKS**

Bldg.	Height (ft.)	Capacity (tons)
AO	45	10
AE	34	6
AM	35	5
Hangar S	20	2

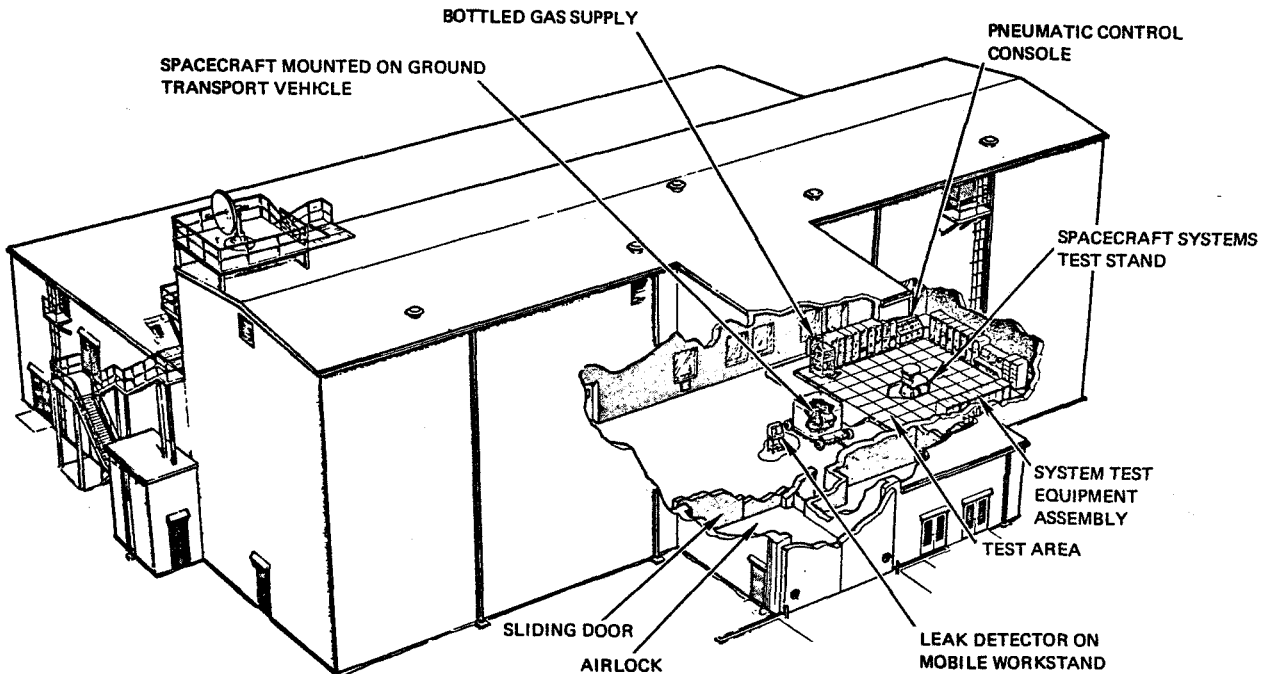

*Building AO*

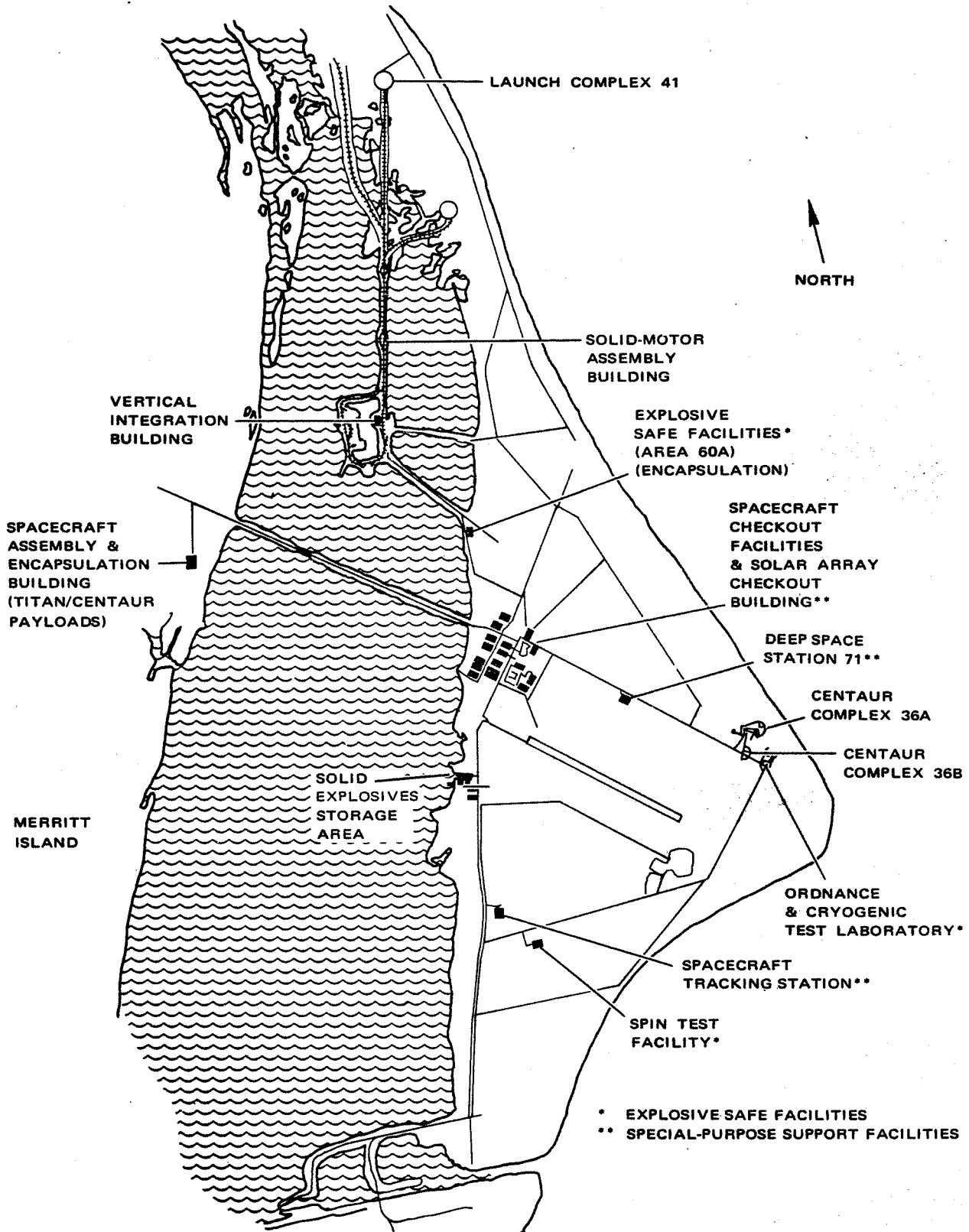

Key Facility Locations at the Eastern Test Range



### CLEAN ROOM ENVIRONMENTS

Bldg.	Class	Temp. (deg. F)	Rel. Hum. (%)
AO	100,000	72 ± 3	45 ± 5
AE	10,000	75 ± 3	45 ± 5
AM	Personnel Comfort	72 ± 5	50 ± 5
Hangar S	100,000	73 ± 3	45 ± 5

### SPACECRAFT ASSEMBLY AND ENCAPSULATION FACILITIES

#### EXPLOSIVE SAFE FACILITY (CENTAUR D-1A)

The facility includes the following.

Area 60A: spacecraft assembly and encapsulation building, including a class 100,000 clean room, propellant loading building, and instrumentation building for remote monitoring.

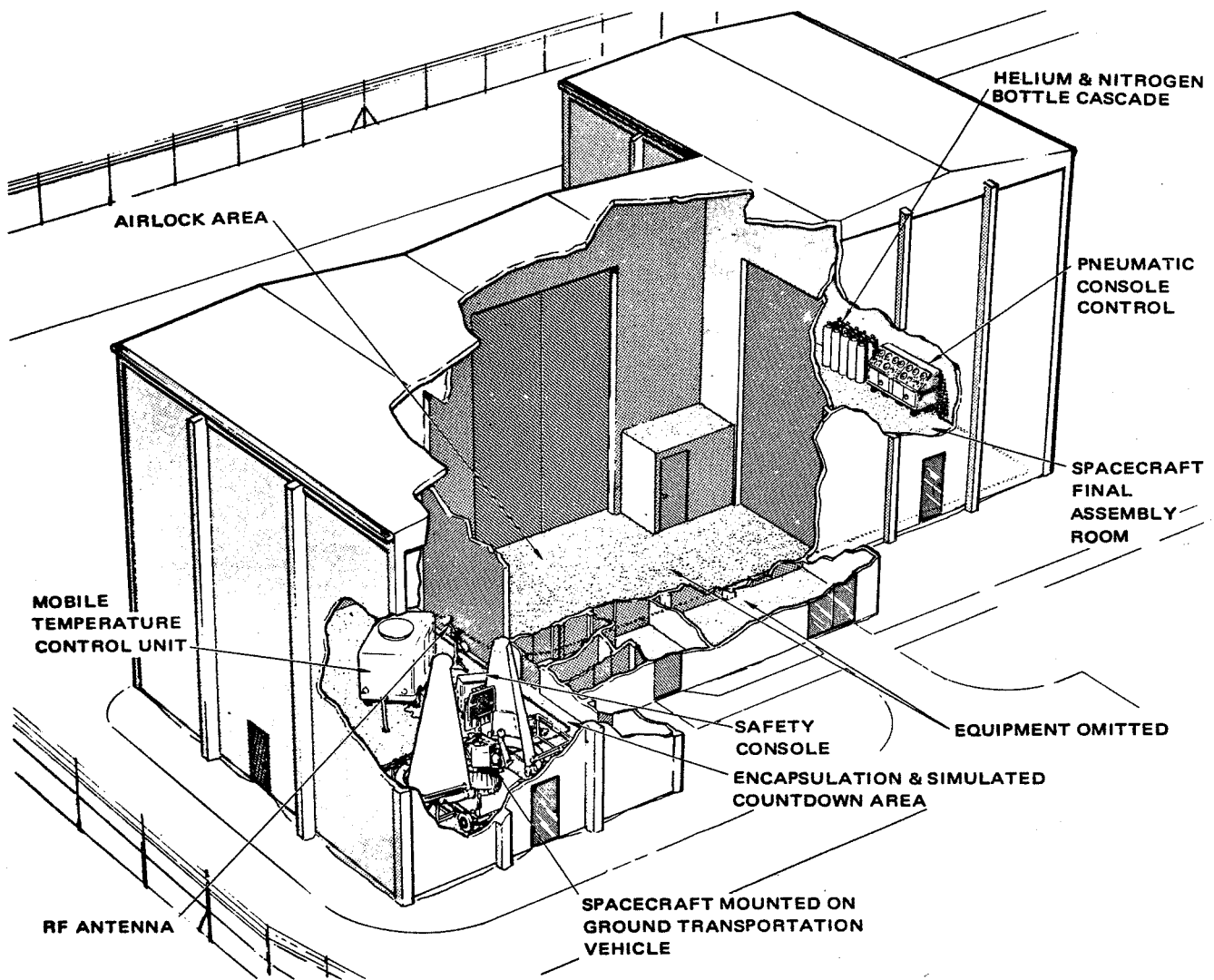

*Spacecraft Assembly Building in the Explosive Safe Facility*

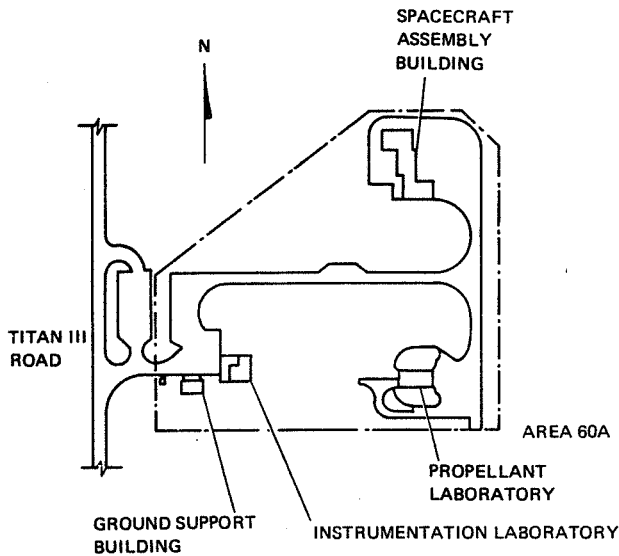

*Explosive Safe Facilities in Area 60A*

Other areas contain the ordnance and cryogenic test building and the spin test building.

Typical operations done in these areas are ordnance installations, including solid rocket motors, high-pressure system tests, spacecraft fueling, cryogenic system tests, spinup, balance and alignment checks. Here also Convair Aerospace encapsulates the spacecraft in the Centaur D-1A standard nose fairing before transfer to the launch complex.

Convair Aerospace has existing ground handling equipment (GHE) for spacecraft encapsulation, transportation, erection, and mating. If an existing adapter is used, no changes are necessary to the GHE fittings.

**SPACECRAFT ASSEMBLY BUILDING**

The building contains two environmentally controlled clean rooms. In the clean rooms temperature is  $72 \pm 3$  degrees F at a relative humidity of  $45 \pm 5\%$ . Access to either room is through an airlock. Each room and the airlock area has a five-ton bridge crane with a 35-foot hook height. (See page 5-10.)

**SPACECRAFT ASSEMBLY AND ENCAPSULATION BUILDINGS (CENTAUR D-1T)**

Encapsulation of payloads that will fly on Titan/Centaur and use the Centaur Standard Shroud will be done in one

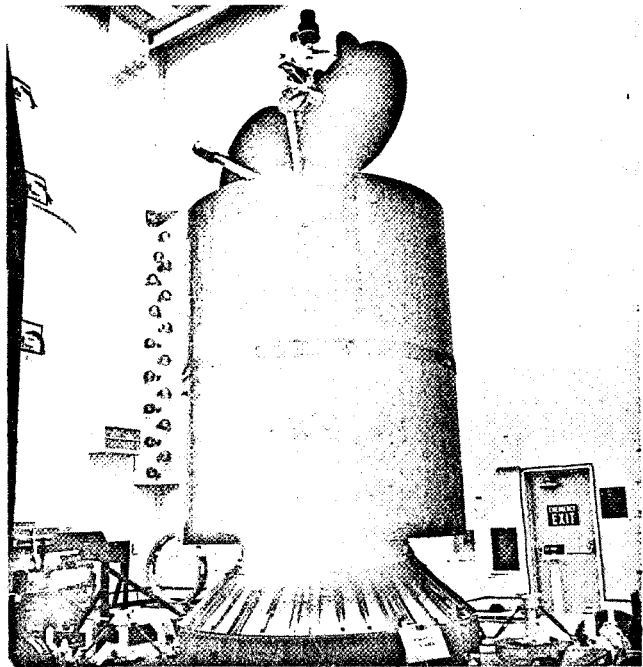

*Intelsat IV and Adapter on Ground Transport Vehicle*

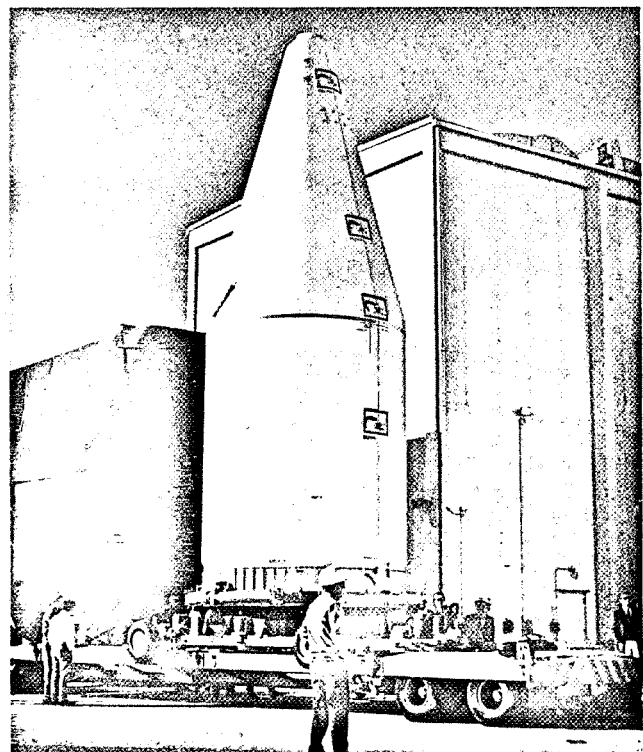

*Fairing and Encapsulated Spacecraft Ready for Transport to Pad*

of the two spacecraft assembly and encapsulation buildings (SAEB), located on Merritt Island. The encapsulated spacecraft and shroud will be transported on a ground transport vehicle over the causeway to Complex 41. Convair Aerospace is responsible for the encapsulation, transport, and launch complex mating to Centaur and the interstage adapter.

**SPECIAL-PURPOSE TEST AND SUPPORT FACILITIES**

**SOLAR ARRAY CHECKOUT BUILDING** – Electrically checks spacecraft solar array systems in sunlight.

**SPACECRAFT TRACKING STATION** – Carries out data transmission analysis, compatibility testing, prelaunch RF support, and launch operations.

**DEEP SPACE STATION 71** – Used for verification and operation with the deep space network.

**CENTRAL INSTRUMENTATION FACILITY** – This is the receiving station for spacecraft telemetry data, data display, and computer services.

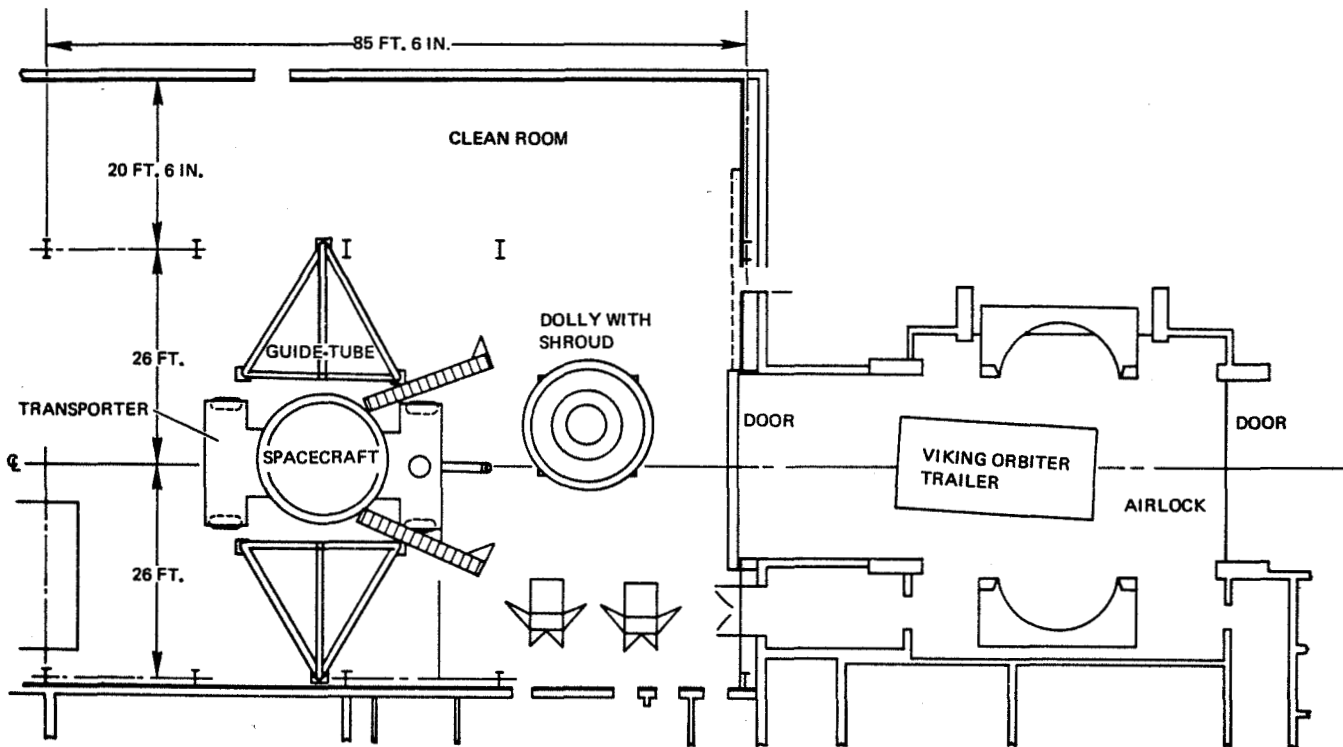

*Preliminary Floor Layout in Spacecraft Assembly and Encapsulation Building*



## CENTAUR EXTENSIONS AND GROWTH

### CENTAUR GT

The 1976-1979 period will present a rare opportunity to launch a multiplanet Grand Tour mission to visit each of the four large outer planets. The baseline launch vehicle selected for the flight is a Titan/Centaur D-1T/TE-364-4. Convair Aerospace currently has an extended-capability Centaur in preliminary design. Purpose of the Centaur Growth Tank (GT) is to increase the amount of scientific payload that can be carried aboard the Grand Tour spacecraft.

The Centaur GT has a standard, ten-foot-diameter oxidizer tank with a 28.6-inch cylindrical extension and a 150-inch-diameter fuel tank. The forward equipment module and stub adapter, and the aft bulkhead and propulsion system are unchanged from the Centaur D-1T. Propellant capacity is increased 50 per cent over Centaur D-1, with a length increase of only 60 inches. The 14-foot Centaur Standard Shroud will be lengthened.

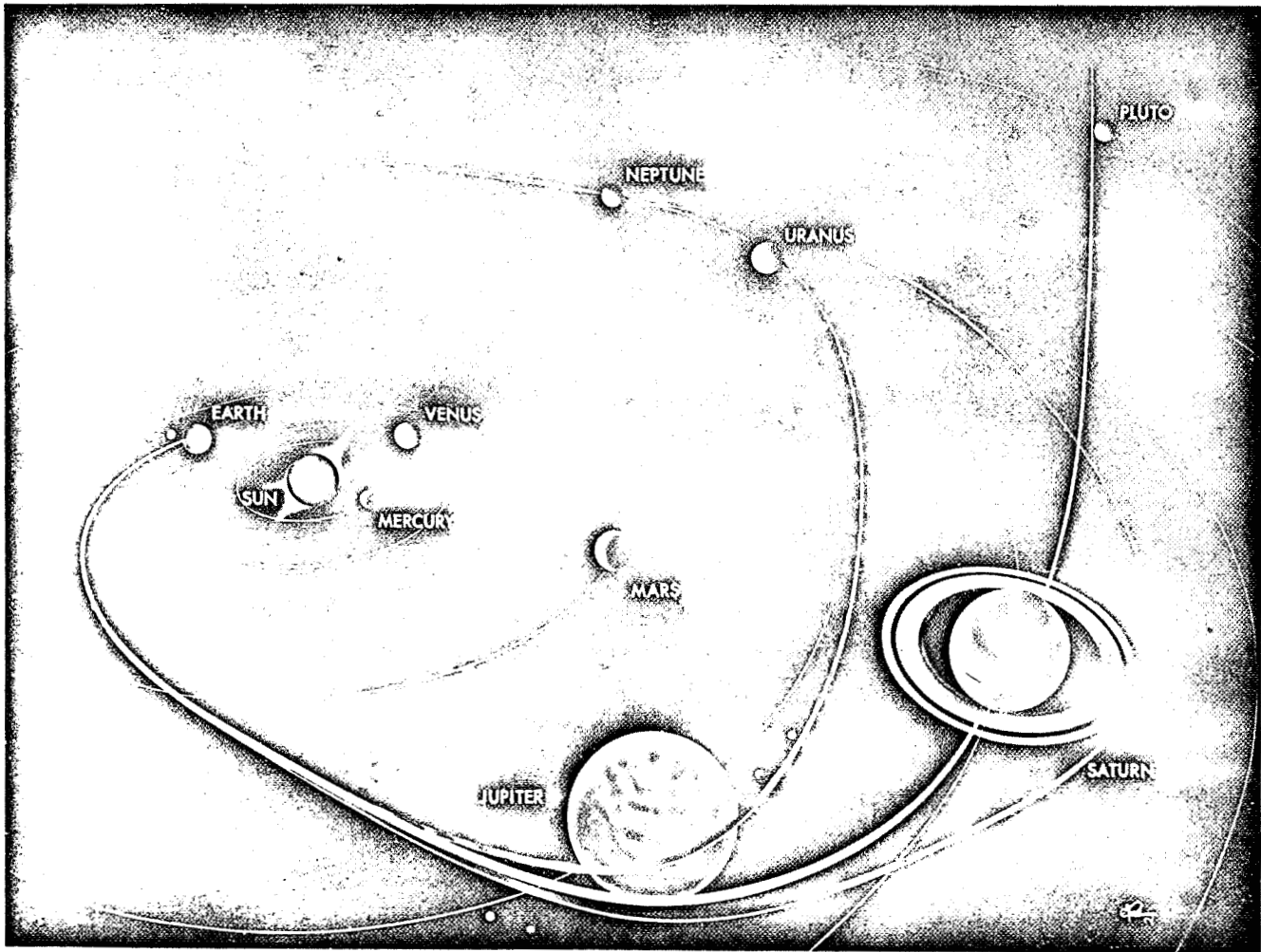

*The Grand Tour Multiplanet Mission*

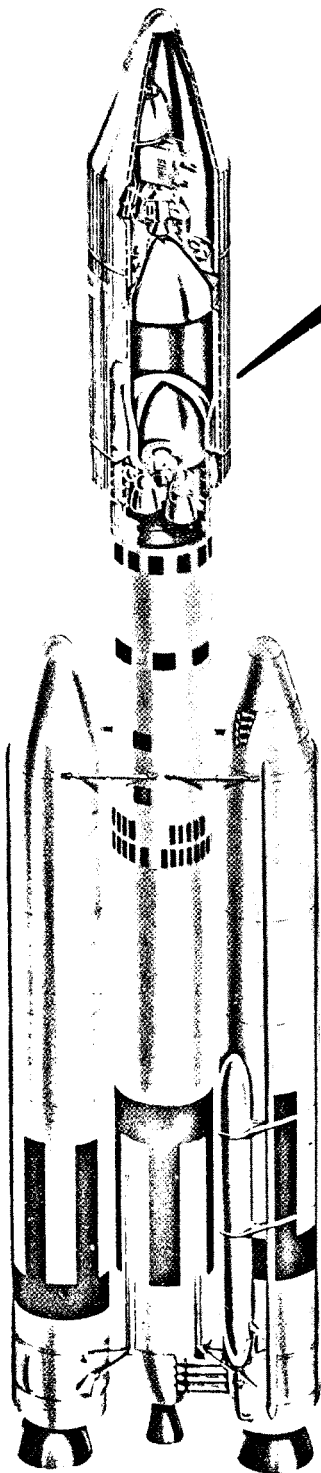

*Titan/Centaur GT Combination*

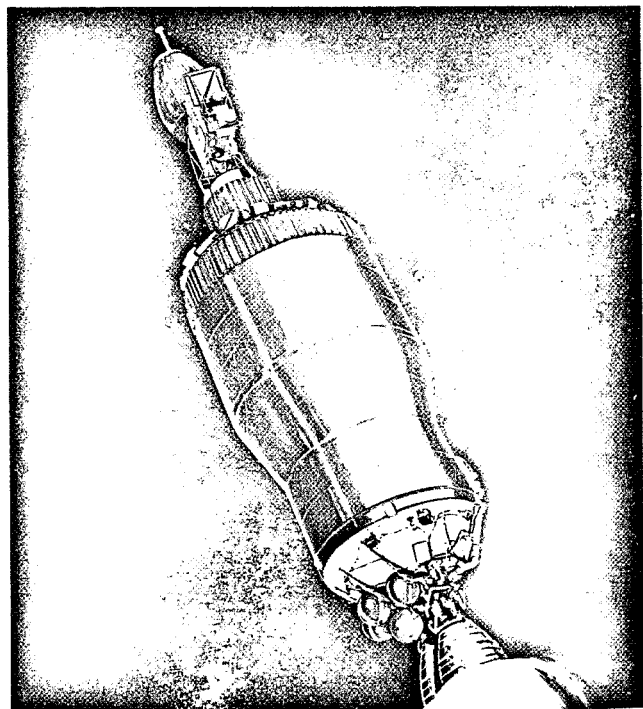
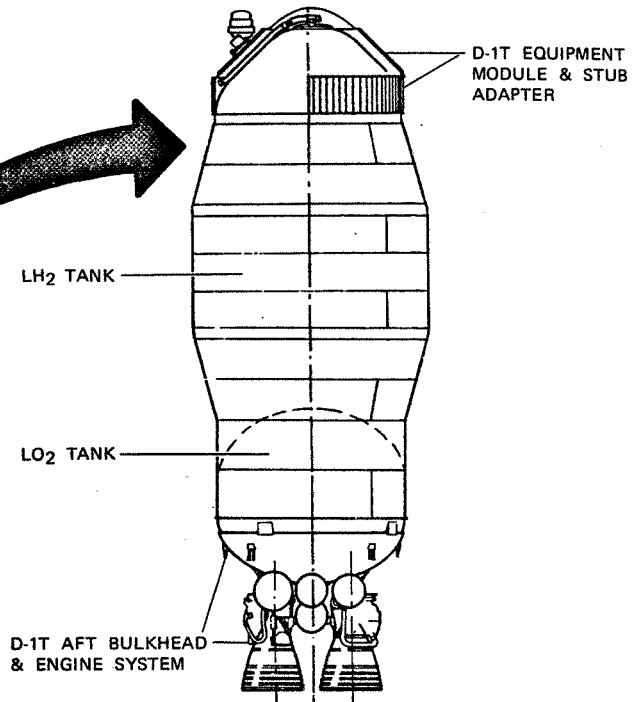

*Extended-Capability Centaur GT*

Titan/Centaur GT, with 45,000 pounds of Centaur propellants, can gain a payload increase of nearly 200 pounds more than Titan/Centaur D-1T for the Grand Tour Mission (with TE-364-4). Payload gain to synchronous equatorial orbit is about 900 pounds. The performance curve shown here presents payload weight as a function of characteristic velocity for the Titan/Centaur GT combination with the Centaur Standard Shroud. Performance is based on a 90-degree launch azimuth from the Air Force Eastern Test Range into a 100-nautical mile parking orbit.

Centaur D-1T. The number of solid motor segments would increase from five to seven. Payload increase to a synchronous equatorial orbit with a three-burn Centaur D-1T is about 2,000 pounds. Performance curves are shown on pages 4-5 through 4-9.

### CENTAUR ORBIT-TO-ORBIT SHUTTLE

Convair Aerospace has studied integration of Centaur and the proposed Space Shuttle orbiter as part of the Space Transportation System for NASA and the Air Force.

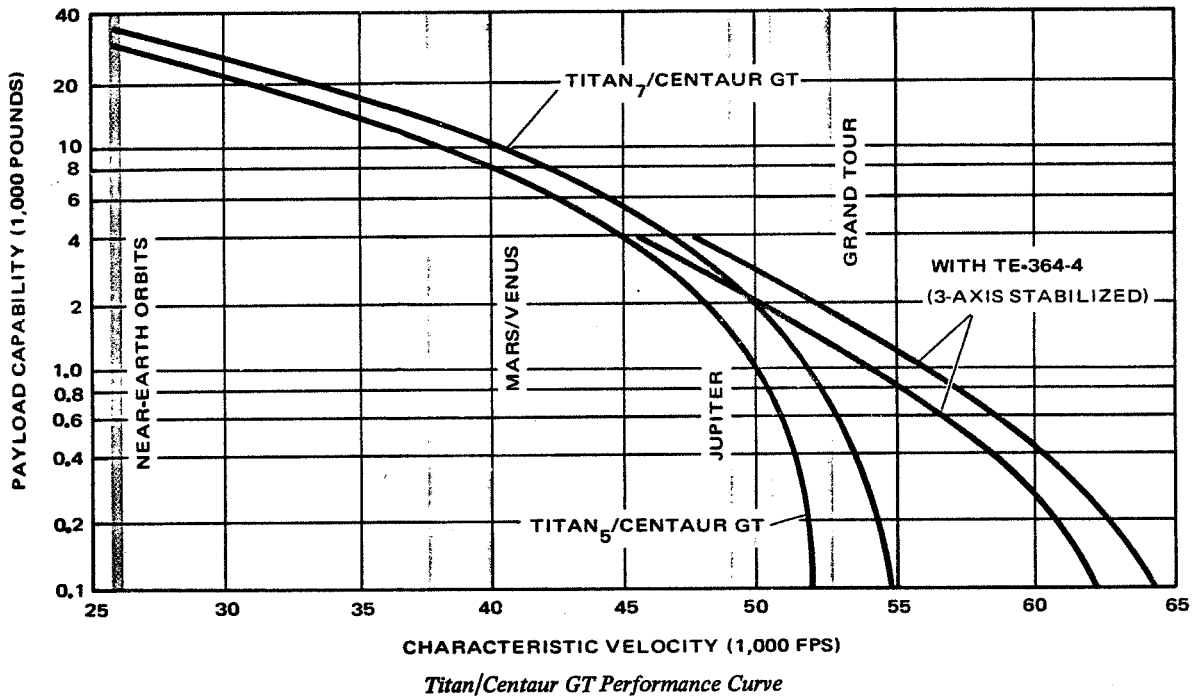

### GROWTH BOOSTERS

#### ATLAS SLV

A stretched version of the Atlas under consideration would extend the Atlas sustainer tank by about 80 inches. Payload increase to a synchronous transfer ellipse with the Centaur D-1A is about 400 pounds. Performance curves are shown on pages 3-5 through 3-10.

#### TITAN III (CENTAUR) BOOSTER

A growth version of Titan is being considered for use with

Studies indicate a requirement for an orbit-to-orbit shuttle (OOS) to extend mission capability from a maximum altitude of about 500 nautical miles to the medium-altitude, geosynchronous, and planetary arenas. Centaur D-1 or GT, modified to be compatible with the orbiter, have the capability to achieve these missions.

Centaur could be readily adapted into a reusable vehicle, returning itself to low earth orbit after delivering its spacecraft. In this mode, the orbiter recovers the Centaur OOS and returns it to earth for refurbishment and reuse.

Centaur will be installed in the cargo bay of the orbiter. The orbiter will ferry it to an altitude of 100 nautical miles, where it will be deployed as an independent system to perform its assigned mission.

**CENTAUR OOS PERFORMANCE**

Centaur OOS performance is shown for both expendable and reusable modes of operation.

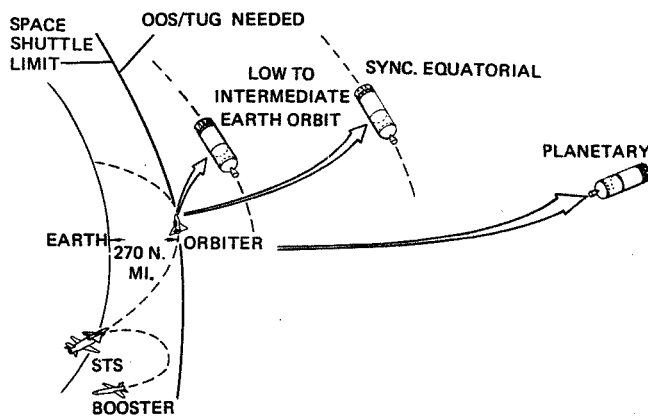

*Mission Arenas for an Orbit-to-Orbit Shuttle*

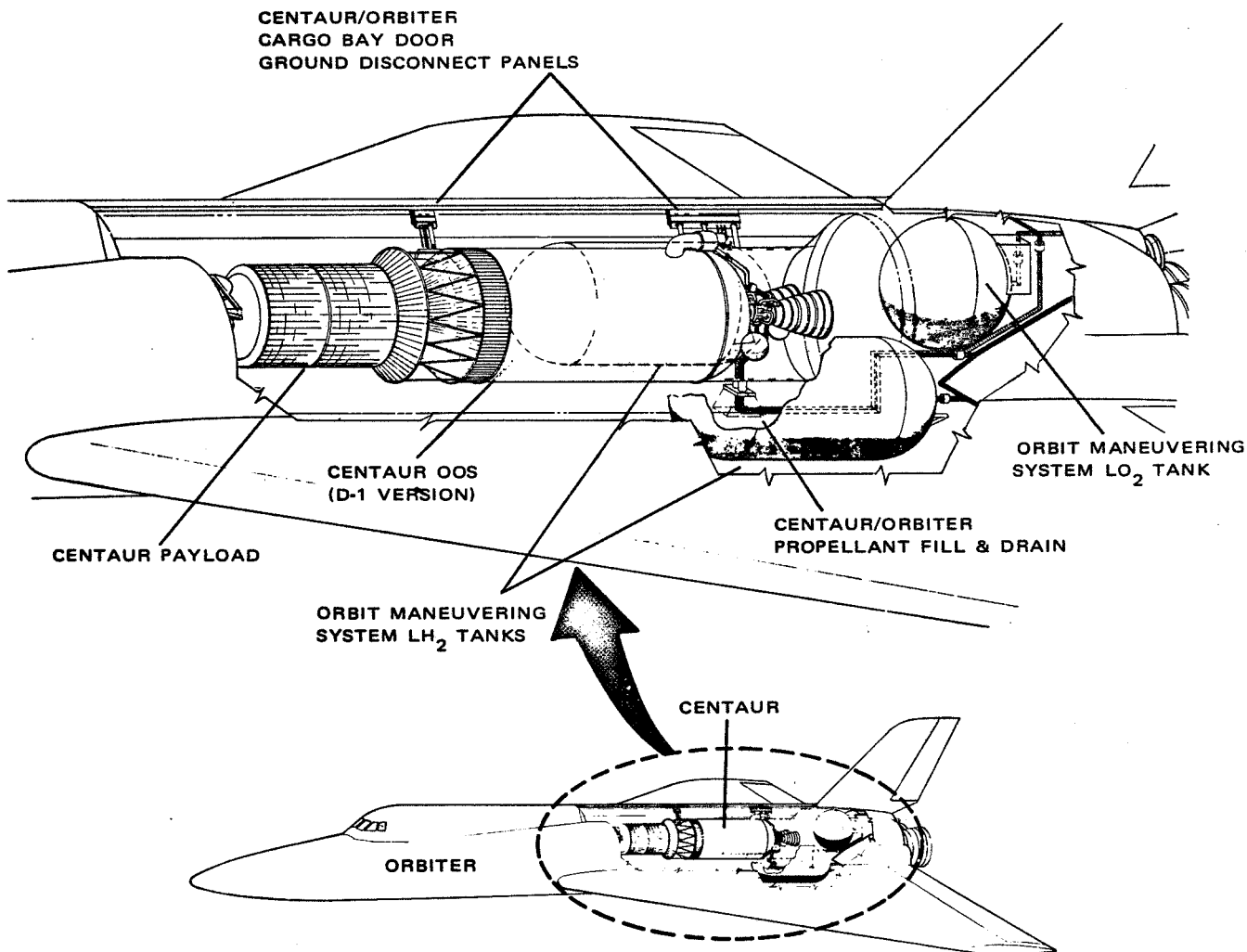

*Centaur Installation in Shuttle Orbiter*



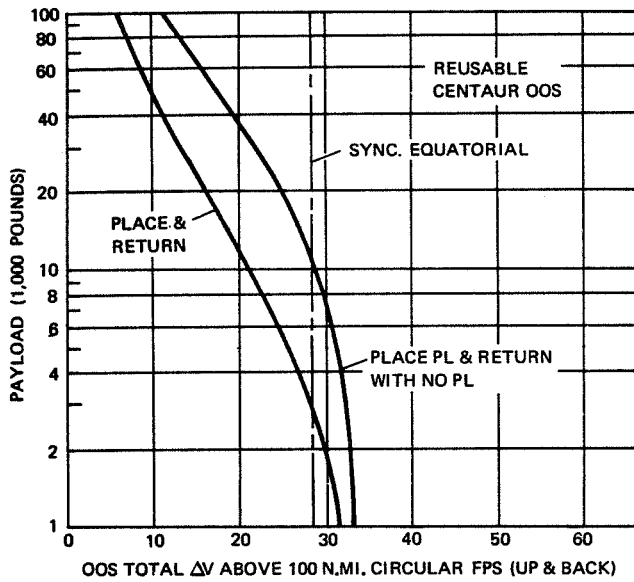

*Reusable Centaur OOS Performance  
(55,000 Pounds of Propellant)*

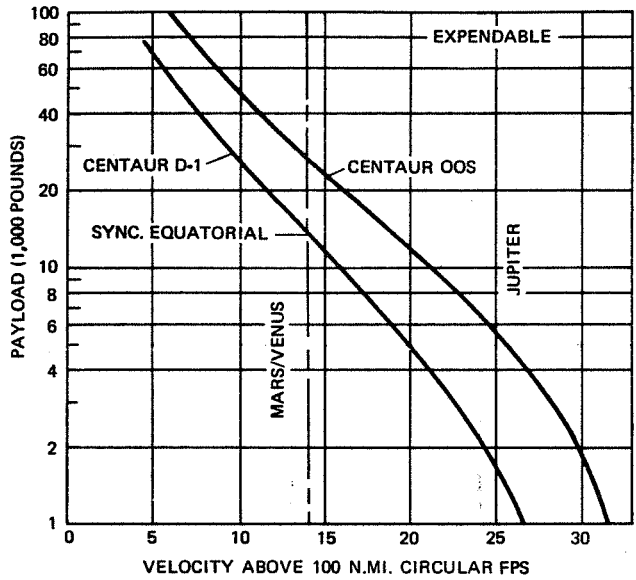

*Expendable Centaur OOS Performance*



## GLOSSARY AND INDEX

### GLOSSARY OF ACRONYMS AND ABBREVIATIONS

AC-	Atlas/Centaur (usually followed by vehicle number)
A/D	Analog to Digital
AFETR	Air Force Eastern Test Range
AGE	Aerospace Ground Equipment
AKM	Apogee Kick Motor
ARC	Ames Research Center
ATS	Applications Technology Satellite
BECO	Booster Engine Cutoff
C <sub>3</sub>	Vis Viva Energy
CCLS	Computer-Controlled Launch Set
CKAFS	Cape Kennedy Air Force Station
CG	Center of Gravity
CERT	Composite Electrical Readiness Test
CSS	Centaur Standard Shroud
D-1A	Centaur D-1A
D-1T	Centaur D-1T
D/A	Digital to Analog
DCU	Digital Computer Unit
DOD	Department of Defense
EMC	Electromagnetic Compatibility
EMI	Electromagnetic Interference
ESF	Explosive Safe Facility
ETR	Eastern Test Range
FAP	Flight Acceleration Profile
FBR	Forward Bearing Reaction
GDCA	Convair Aerospace Division of General Dynamics
GHE	Ground Handling Equipment
GMT	Greenwich Mean Time
GSE	Ground Support Equipment
GSFC	Goddard Space Flight Center
H <sub>2</sub> O <sub>2</sub>	Hydrogen Peroxide
Hz	Hertz (cycles per second)
ICD	Interface Control Drawings
IFWG	Interface Working Group
I/O	Input/Output
IPSD	Interface Plan and Schedule Document
IRD	Interface Requirements Document
IRU	Inertial Reference Unit
ITL	Integrate-Transfer-Launch
JPL	Jet Propulsion Laboratory
LC	Launch Complex
LeRC	Lewis Research Center
LH <sub>2</sub>	Liquid Hydrogen

<b>LO<sub>2</sub></b>	<b>Liquid Oxygen</b>
<b>LOWG</b>	<b>Launch Operations Working Group</b>
<b>LRC</b>	<b>Langley Research Center</b>
<b>LV</b>	<b>Launch Vehicle</b>
<b>MBB</b>	<b>Messerschmidt-Boelkow-Blohm</b>
<b>MDF</b>	<b>Mild Detonating Fuse</b>
<b>MECO</b>	<b>Main Engine Cutoff</b>
<b>MES</b>	<b>Main Engine Start</b>
<b>MST</b>	<b>Mobile Service Tower</b>
<b>N<sub>2</sub>O<sub>4</sub></b>	<b>Nitrogen Tetroxide</b>
<b>NASA</b>	<b>National Aeronautics and Space Administration</b>
<b>OAO</b>	<b>Orbiting Astronomical Observatory</b>
<b>OOS</b>	<b>Orbit-to-Orbit Shuttle</b>
<b>PCM</b>	<b>Pulse Code Modulation</b>
<b>PL</b>	<b>Payload</b>
<b>psia(g)</b>	<b>Pressure, pounds per square inch, absolute (gage)</b>
<b>PT&amp;G</b>	<b>Performance, Trajectory, and Guidance Working Group</b>
<b>PU</b>	<b>Propellant Utilization</b>
<b>P&amp;W</b>	<b>Pratt &amp; Whitney</b>
<b>RF</b>	<b>Radio Frequency</b>
<b>RFI</b>	<b>Radio Frequency Interference</b>
<b>RMU</b>	<b>Remote Multiplexer Unit</b>
<b>RSC</b>	<b>Range Safety Command</b>
<b>RTG</b>	<b>Radioisotope Thermoelectric Generator</b>
<b>S&amp;A</b>	<b>Safe and Arm</b>
<b>SAEB</b>	<b>Spacecraft Assembly and Encapsulation Building</b>
<b>SAMSO</b>	<b>Spacecraft and Missile Systems Organization (USAF)</b>
<b>SC</b>	<b>Spacecraft</b>
<b>SCF</b>	<b>Spacecraft Checkout Facilities</b>
<b>SCU</b>	<b>Sequence Control Unit</b>
<b>SECO</b>	<b>Sustainer Engine Cutoff</b>
<b>SIU</b>	<b>Servo Inverter Unit</b>
<b>SLV</b>	<b>Space Launch Vehicle</b>
<b>SMAB</b>	<b>Solid Motor Assembly Building</b>
<b>Sta.</b>	<b>Station</b>
<b>SRM</b>	<b>Solid Rocket Motor</b>
<b>TCD</b>	<b>Terminal Countdown Demonstration</b>
<b>TLM</b>	<b>Telemetry</b>
<b>T/W</b>	<b>Thrust-to-Weight Ratio</b>
<b>UDMH</b>	<b>Unsymmetrical Dimethylhydrazine</b>
<b>UES</b>	<b>Universal Environment Shelter</b>
<b>VIB</b>	<b>Vertical Integration Building</b>

## INDEX

- Abbreviations, 7-1
- Accuracy, 3-11
- Acronyms, 7-1
- Adapters, 3-15, 4-11
- Agencies, 1-1, 5-1
- Applications technology satellite (ATS), 1-5
- Atlas/Centaur configuration, 3-2
- Atlas description, 3-4
  - growth, 3-5, 6-3
- Axes, 3-4, 4-4
- Blockhouse, LC 36, 3-24
  - ITL launch control center, 4-16
- Centaur astronics, 2-4
  - description, 2-1
  - D-1A, 2-1, 2-9
  - D-1T, 2-8, 2-9
  - development, history of, 1-2
  - GT, 6-1
  - orbit-to-orbit shuttle (OOS), 6-3
  - propulsion, 2-1, 2-3
  - Standard Shroud, 4-10
  - structure, 2-1
  - three-burn, 2-9
- Central instrumentation facility, 5-9, 5-12
- Composite electrical readiness test, 5-3, 5-4
- Computer-controlled launch set (CCLS), 2-6
- Convair Aerospace, 5-1
- Deep space station 71, 5-9, 5-12
- Eastern Test Range, map of, 5-9
- Encapsulation, 5-11, 5-12
- Environment, 3-18, 4-13
  - acoustics, 3-19, 4-13
  - air conditioning, 3-24, 4-16
  - internal pressure, 3-21, 4-15
  - load factors, 3-19, 4-13
  - shock, 3-19, 4-13
  - thermal characteristics, 3-20, 4-14
  - thermal control, 3-20, 4-14
  - vibration, 3-18, 4-13
- Explosive safe facilities, 5-10
- Fabrication, 3-26
- Fairing, Centaur D-1A, 3-13
  - Centaur D-1T (see shroud)
- Flight acceleration profile (FAP), 2-6
- Flight events demonstration (FED), 5-3
- Flight history, 1-3
  - profile, 3-6, 4-6
- Glossary, 7-1
- Grand Tour Mission, 6-1
- Ground handling equipment (GHE), 5-11
- Helios, 1-8
- Integration, 5-1
- Integrate-Transfer-Launch facility, 4-15, 5-9
- Intelsat IV, 1-6, 3-12
- Interface documents, 5-3
- Interfaces, 3-15
- Kennedy Space Center, map of, 5-9
- Launch Complex 36, 3-21, 5-9
- Launch Complex 41, 4-16, 5-9
- Launch Complex spacecraft services, 3-24, 4-17
- Launch control center, 4-16
- Launch facilities, 3-21, 4-15, 5-9
  - procedures, 5-6, 5-7
- Locations (ETR), 5-9
- Mariner Mars '69, 1-5, 3-11, 3-12
- Mariner Mars '71, 1-6, 3-12
- Mariner Venus/Mercury '73, 1-7
- Missions, future, 1-6, 6-1
  - past, 1-3
- Mobile service tower, 3-21, 4-16
- Orbit-to-orbit shuttle, 6-3
- Operations, checkout, 5-3 through 5-7
  - launch, 5-3 through 5-7
- Orbiting Astronomical Observatory (OAO), 1-4, 3-11
- Payload (see spacecraft)
- Performance, 3-5, 4-5, 6-3, 6-5
- Pioneer F and G, 1-7, 3-12
- Prelaunch procedures, 5-3 through 5-7
- Procurement, 3-3, 3-24, 4-3, 4-18

Quadrants, 3-4, 4-4

Record, Atlas/Centaur, 1-3

Sequences, 3-7, 4-7

Shroud, Centaur Standard, 4-10

Software, flight, 2-5

Solar Array Checkout Building, 5-9, 5-12

Spacecraft adapters, 3-15, 4-11

Assembly Building (part of ESF), 5-10

Assembly and Encapsulation Building, 5-11

center of gravity, 3-16, 4-12

characteristics, 1-4 through 1-9

checkout facilities, 5-8

envelope, 3-13, 4-10

separation, 3-17

services (airborne), 3-16

services (ETR), 5-8 through 5-12

services (LC), 3-24, 4-16

spin test facility, 5-11

tracking station, 5-9, 5-12

Station numbers, 3-4, 4-4

Structure, Centaur, 2-1

Surveyor, 1-4

Terminal countdown demonstration, 5-3

Tests, 5-3, 5-6, 5-7

Titan/Centaur configuration, 4-2

Titan description, 4-4

growth, 6-3

Trajectory, 3-6, 4-6

Umbilical (airborne), 3-16, 4-12

Umbilical towers, 3-21, 4-17

Universal Environment Shelter, 4-16, 4-18

Vertical Integration Building, 4-15, 5-9

Viking, 1-7

Working groups, 5-2