

General Disclaimer

One or more of the Following Statements may affect this Document

- This document has been reproduced from the best copy furnished by the organizational source. It is being released in the interest of making available as much information as possible.
- This document may contain data, which exceeds the sheet parameters. It was furnished in this condition by the organizational source and is the best copy available.
- This document may contain tone-on-tone or color graphs, charts and/or pictures, which have been reproduced in black and white.
- This document is paginated as submitted by the original source.
- Portions of this document are not fully legible due to the historical nature of some of the material. However, it is the best reproduction available from the original submission.

100



(NASA-CR-171000) SPACE SHUTTLE MAIN ENGINE
POWERHEAD STRUCTURAL MODELING, STRESS AND
FATIGUE LIFE ANALYSIS. VOLUME 2: DYNAMICS
OF BLADES AND NOZZLES SSME HFPTP AND HPOTP
Final Report (Lockheed Missiles and Space

N84-20636

Unclas
G3/20 18781

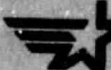

 **Lockheed**

Missiles & Space Company

Huntsville Research & Engineering Center

4800 Bradford Drive, Huntsville, AL 35807

 **Lockheed**
Missiles & Space Company, Inc
Huntsville Research & Engineering Center

Cummings Research Park
4800 Bradford Drive
Huntsville, AL 35807

SPACE SHUTTLE MAIN ENGINE
POWERHEAD STRUCTURAL MODELING,
STRESS AND FATIGUE LIFE ANALYSIS

VOLUME II — DYNAMICS OF BLADES
AND NOZZLES SSME HPFTP
AND HPOTP

December 1983

Contract NAS8-34978

Prepared for National Aeronautics and Space Administration
Marshall Space Flight Center, AL 35812

J.C. Hammett
C.H. Hayes
J.M. Price
J.K. Robinson
G.A. Teal
J.M. Thomson
D.M. Tilley
C.T. Welch

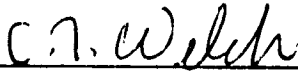
APPROVED 
C.T. Welch, Manager (Acting)
Product Engineering & Development Section

S.V. Bourgeois
Director

FOREWORD

This report summarizes the results of work performed on Contract NAS8-34978. The work was performed by personnel of the Product Engineering & Development Section of Lockheed's Huntsville Research & Engineering Center, for the National Aeronautics and Space Administration, George C. Marshall Space Flight Center, Alabama. The Contracting Officer's technical representative for this study is Mr. Norman C. Schlemmer, Structures and Propulsion Laboratory, Engineering Analysis Division, Stress Analysis Branch (EP46).

This report is divided into four volumes with a section covering one aspect of analysis for all components and loads, and a fourth section for investigation of unscheduled events and special tasks undertaken during the effort. The volumes are:

- Volume I - Gasdynamic Environment of the SSME HPFTP and HPOTP Turbines, LMSC-HREC TR D867333-I.
- Volume II - Dynamics of Blades and Nozzles - SSME HPFTP and HPOTP, LMSC-HREC TR D867333-II.
- Volume III - Stress Summary of Blades and Nozzles at FPL and 115 percent RPL Loads SSME HPFTP and HPOTP Blades and Nozzles, LMSC-HREC TR D867333-III.
- Volume IV - Summary of Investigation of Unscheduled Events and Special Tasks, LMSC-HREC TR D867333-IV.

It should be noted that this report summarized our findings. A great body of data exists in the form of computer printout and magnetic tapes and is available to any interested reader for either amplification of the summarized data or as a basis for further work.

CONTENTS

<u>Section</u>		<u>Page</u>
	FOREWORD	ii
1	INTRODUCTION	1-1
2	SSME TURBOPUMP BLADES	2-1
	2.1 SSME Blades - Model Description	2-1
	2.2 HPFTP First Stage Turbine Blade Dynamics	2-26
	2.3 HPFTP Second Stage Turbine Blade Dynamics	2-38
	2.4 HPOTP First Stage Turbine Blade Dynamics	2-50
	2.5 HPOTP Second Stage Turbine Blade Dynamics	2-62
3	SSME NOZZLE DYNAMICS	3-1
	3.1 SSME Nozzles - Model Description and Summary of Results	3-1

1. INTRODUCTION

The objective of this phase of the analysis was to define normal modes of the blades and nozzles of the HPFTP and HPOTP and to identify potential driving forces for the blades. No attempt was made to identify nozzle drivers due to the lack of definition of these potential forces. These are expected in future analysis.

Section 2 describes the computer models used in blade analyses, with results. Section 3 gives similar information for the nozzles.

2. SSME TURBOPUMP BLADES

Section 2.1 describes the computer models used for this analysis and provides a guide for the reader in following the subsequent results, shown in Sections 2.2 through 2.5.

2.1 SSME BLADES - MODEL DESCRIPTION

Four NASTRAN models were constructed to simulate the first and second stage turbine blades of the HPFTP and the HPOTP. The general approach to modeling of all four models is the same making use of eight-node solid elements to represent the turbine blade geometry. Figures 2-1 through 2-4 show computer generated plots and specifications of each turbine blade model. The series of figures following these plots gives more specific information pertaining to grid and element locations. The models are defined in a rectangular coordinate system with Z radially outward and X in the direction opposite of gas flow. The turbine blades were modeled in their entirety with the exception of the "fir tree" on each blade which was not modeled to avoid additional size and complexity. The models were constrained at the base of the shank in all directions in order to simulate the rotor disk.

The models were executed to extract the normal mode frequencies and to plot the mode shapes. Tabular listings of frequencies for each turbine blade as well as Campbell diagrams and plots of the mode shapes for the first 10 modes are contained in Sections 2.2 through 2.5.

ORIGINAL PAGE 19
OF POOR QUALITY

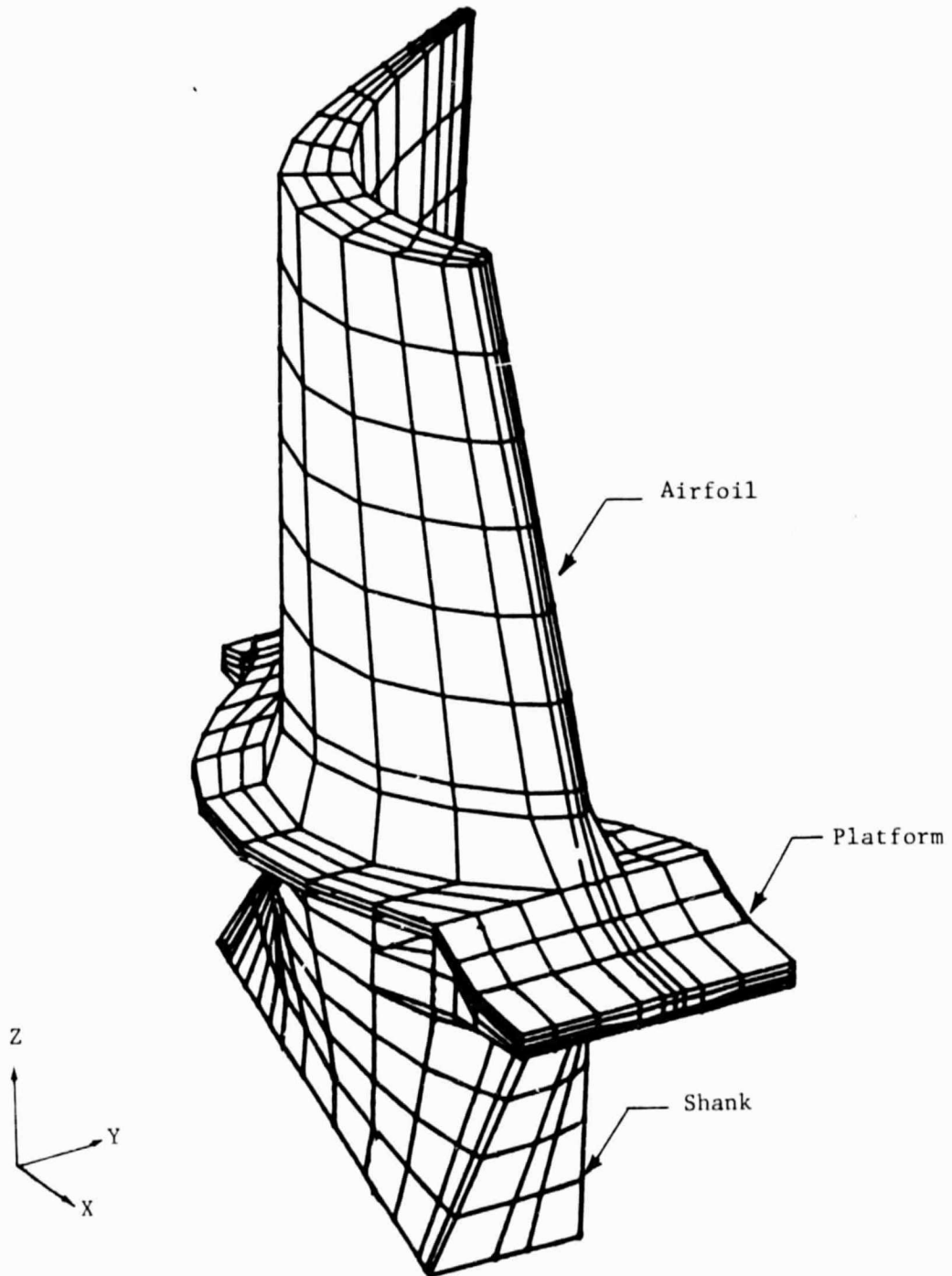

Fig. 2-1a HPFTP First Stage Turbine Blade (F-1) NASTRAN Model
(1575 Nodes, 1025 Elements)

ORIGINAL PAGE IS
OF POOR QUALITY

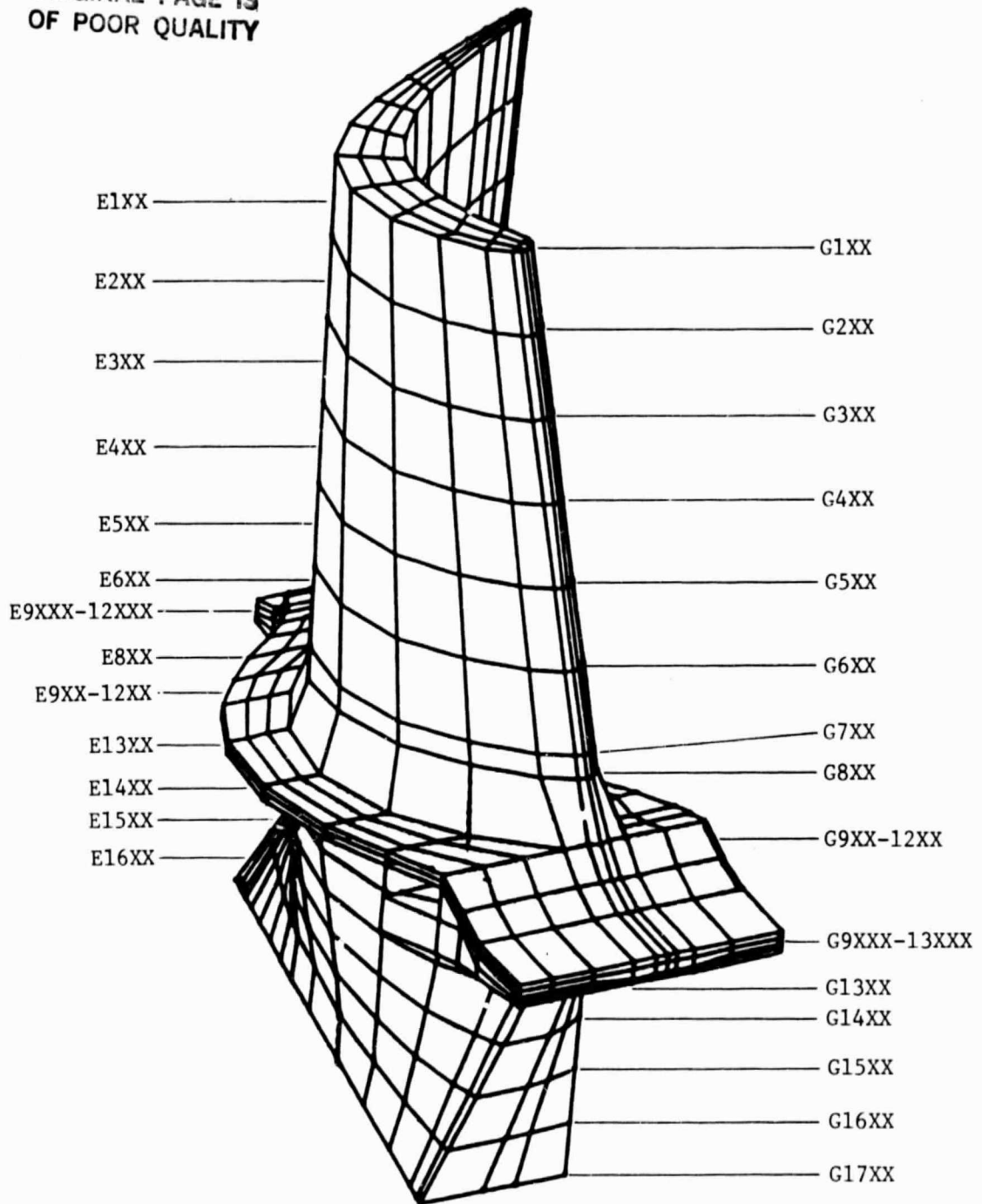

Fig. 2-1b F-1 Element and Grid Prefixes

ORIGINAL PAGE 19
OF POOR QUALITY

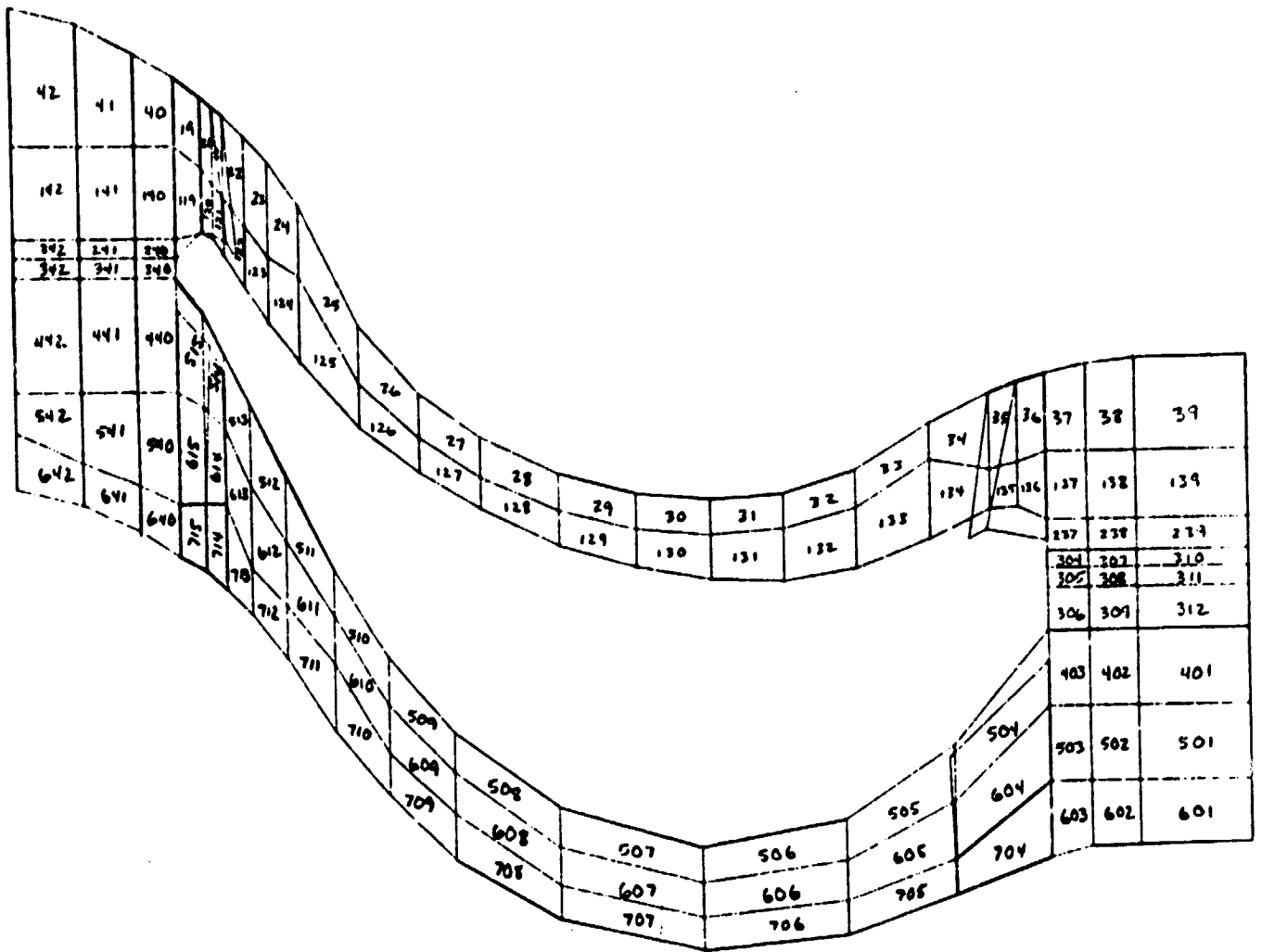

Fig. 2-1c F-1 Platform Element Layout

ORIGINAL PAGE IS
OF POOR QUALITY

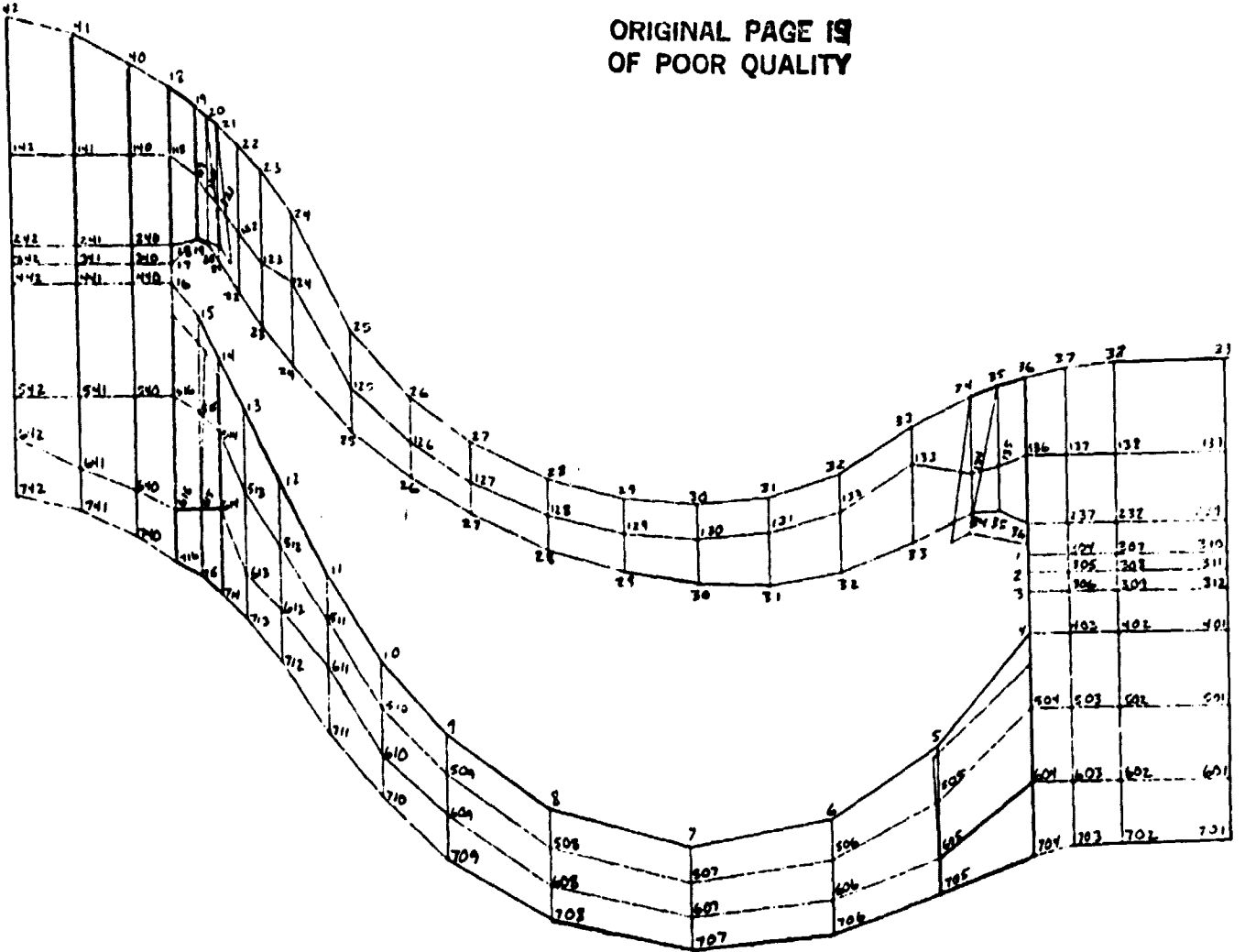

Fig. 2-1d F-1 Platform Grid Layout

ORIGINAL PAGE IS
OF POOR QUALITY.

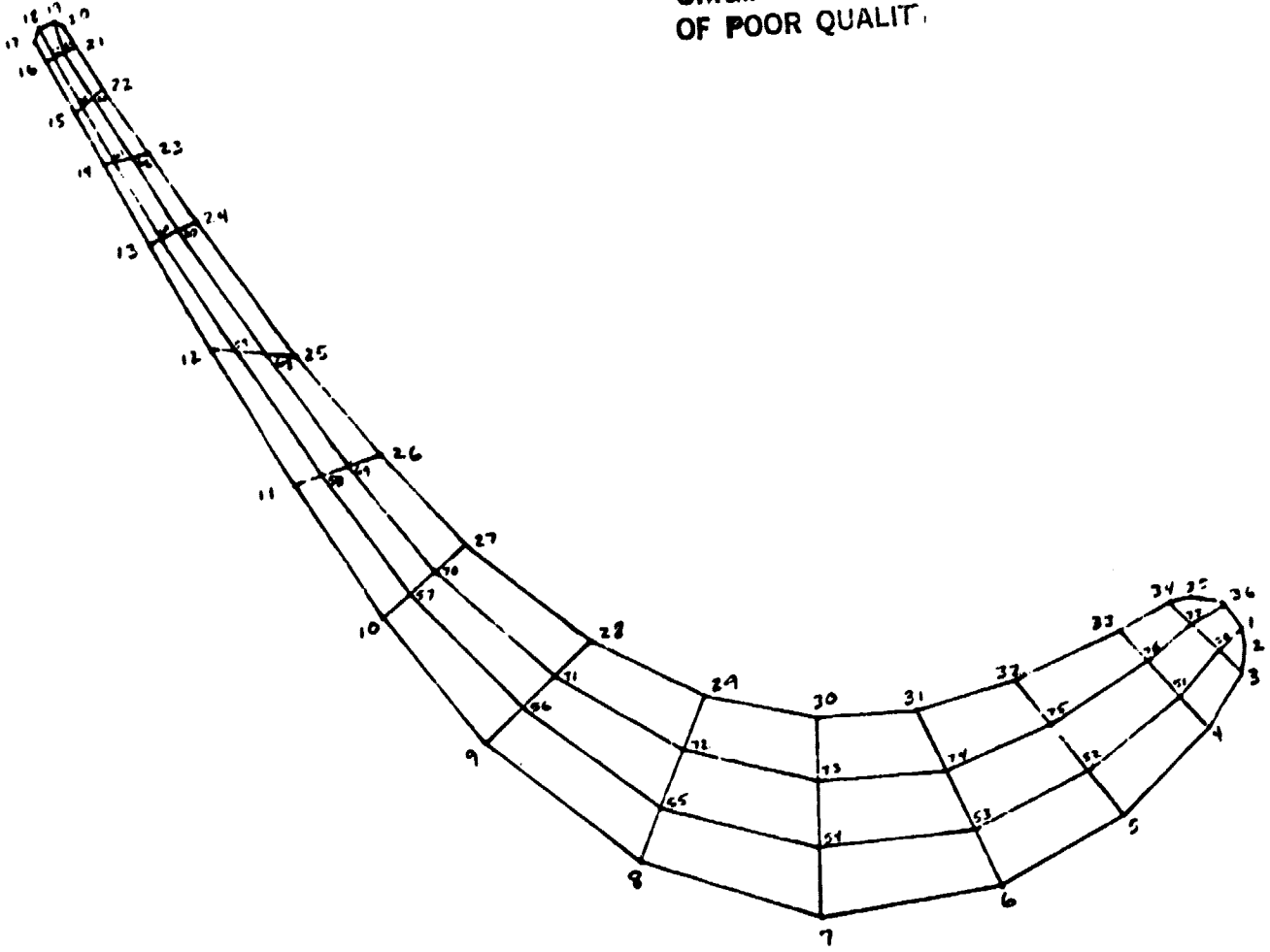

Fig. 2-1e F-1 Airfoil/Shank Grid Layout

ORIGINAL PAGE IS
OF POOR QUALITY

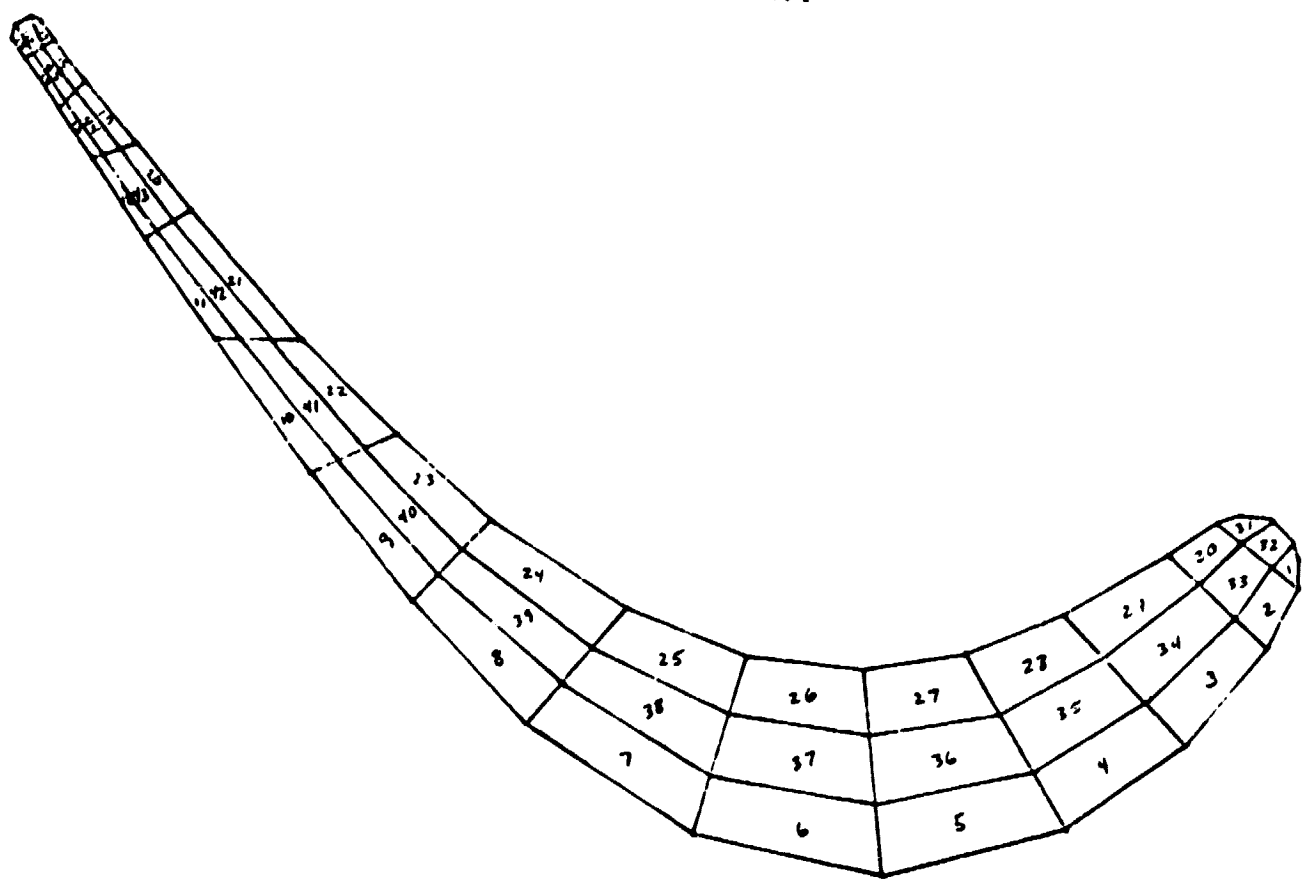

Fig. 2-1f F1 Airfoil/Shank Element Layout

ORIGINAL PAGE IS
OF POOR QUALITY

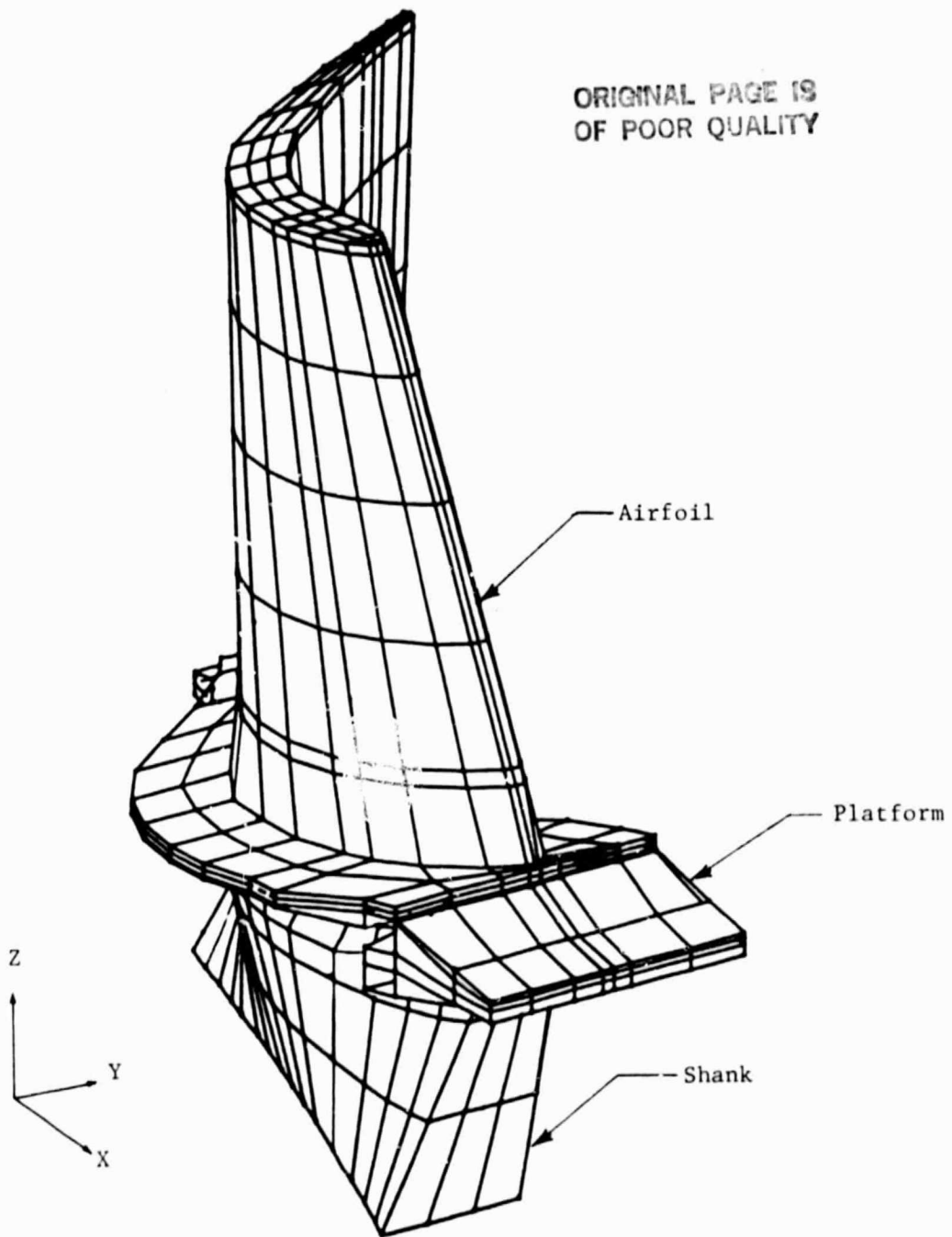

Fig. 2-2a HPFTP Second Stage Turbine Blade (F-2) NASTRAN Model
(1733 Nodes, 1185 Elements)

ORIGINAL PAGE IS
OF POOR QUALITY

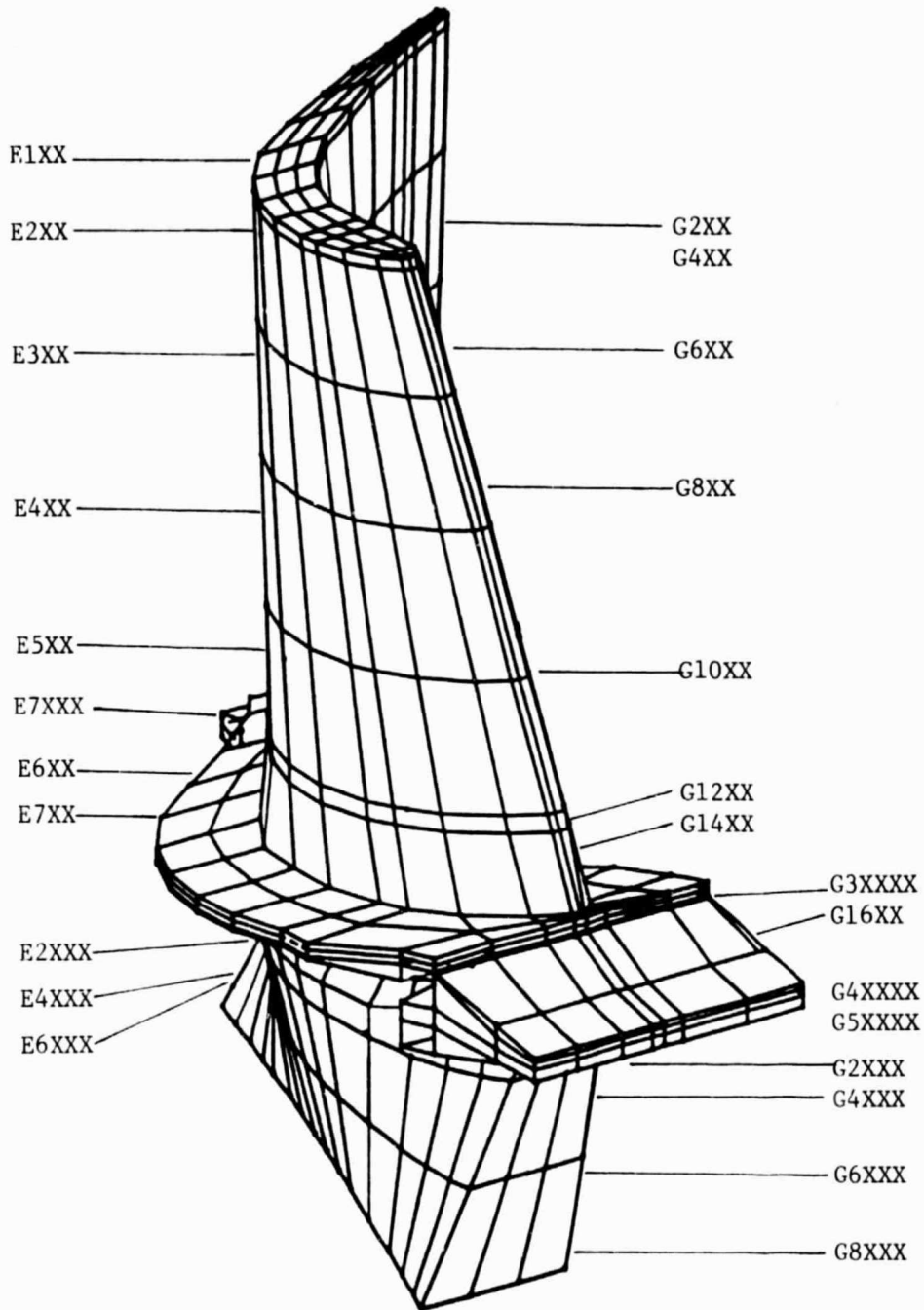

Fig. 2-2b F-2 Element and Grid Prefixes

ORIGINAL PAGE IS
OF POOR QUALITY

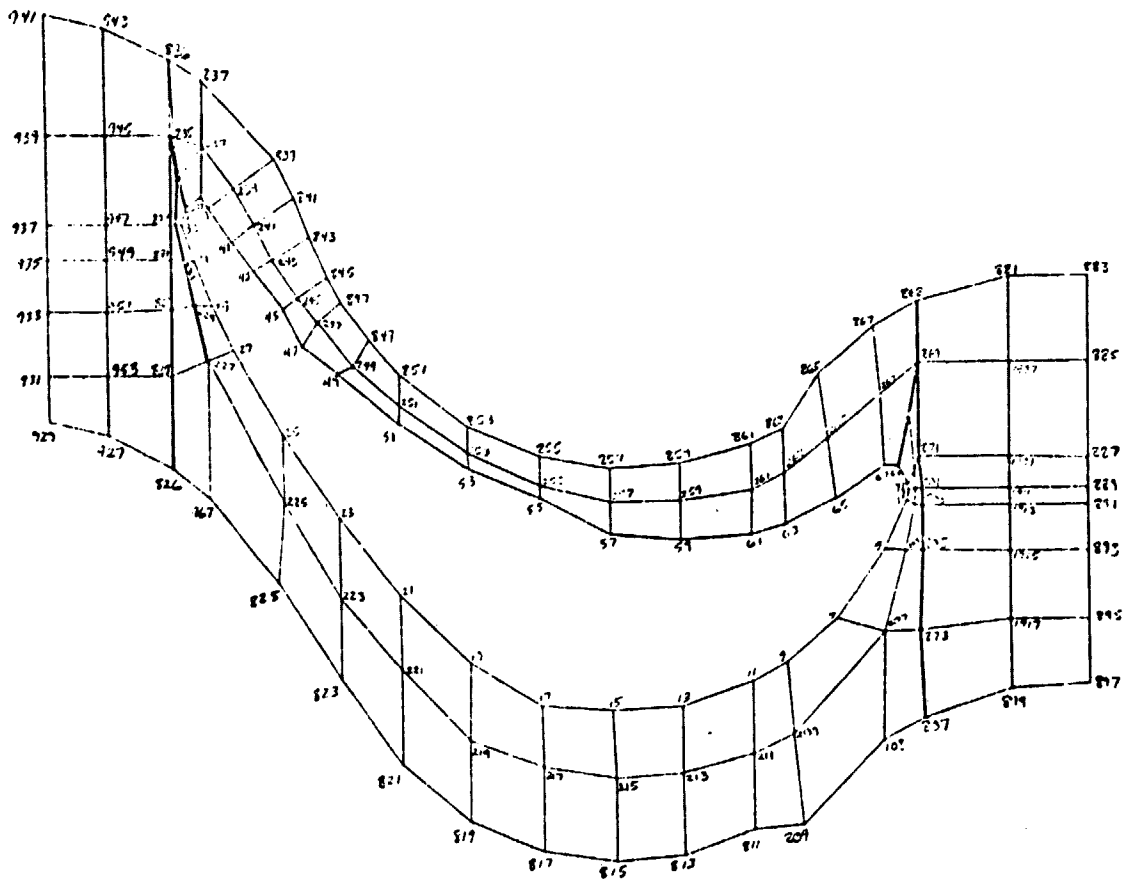

Fig. 2-2c F-2 Platform Grid Layout

ORIGINAL PAGE IS
OF POOR QUALITY

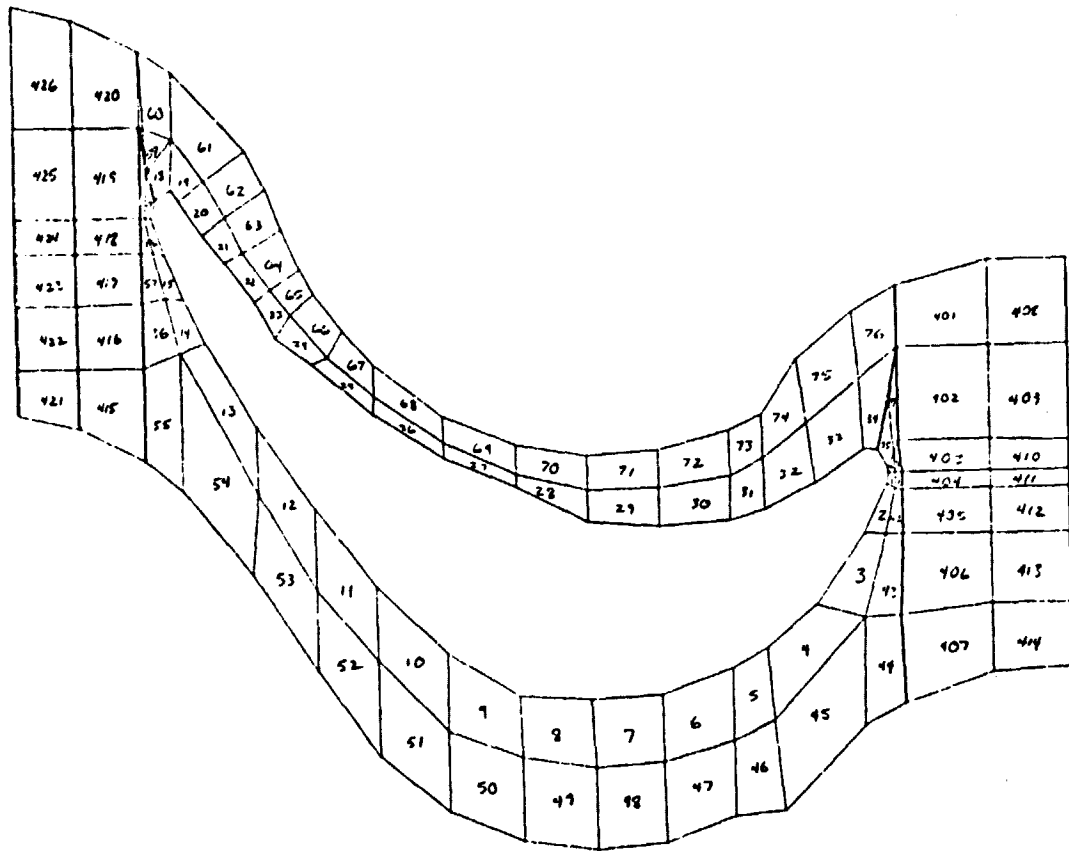

Fig. 2-2d F-2 Platform Element Layout

ORIGINAL PAGE IS
OF POOR QUALITY

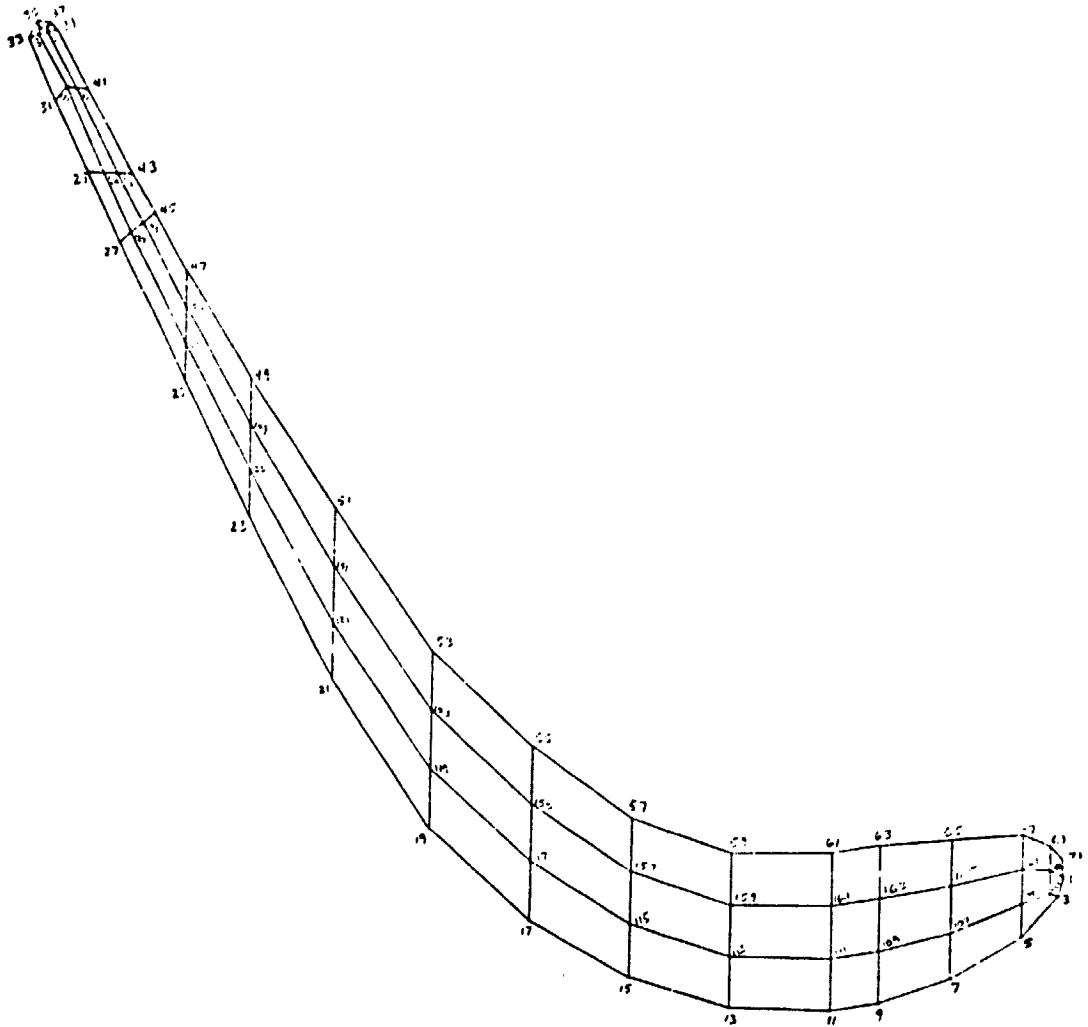

Fig. 2-2e F-2 Airfoil/Shank Grid Layout

ORIGINAL PAGE IS
OF POOR QUALITY

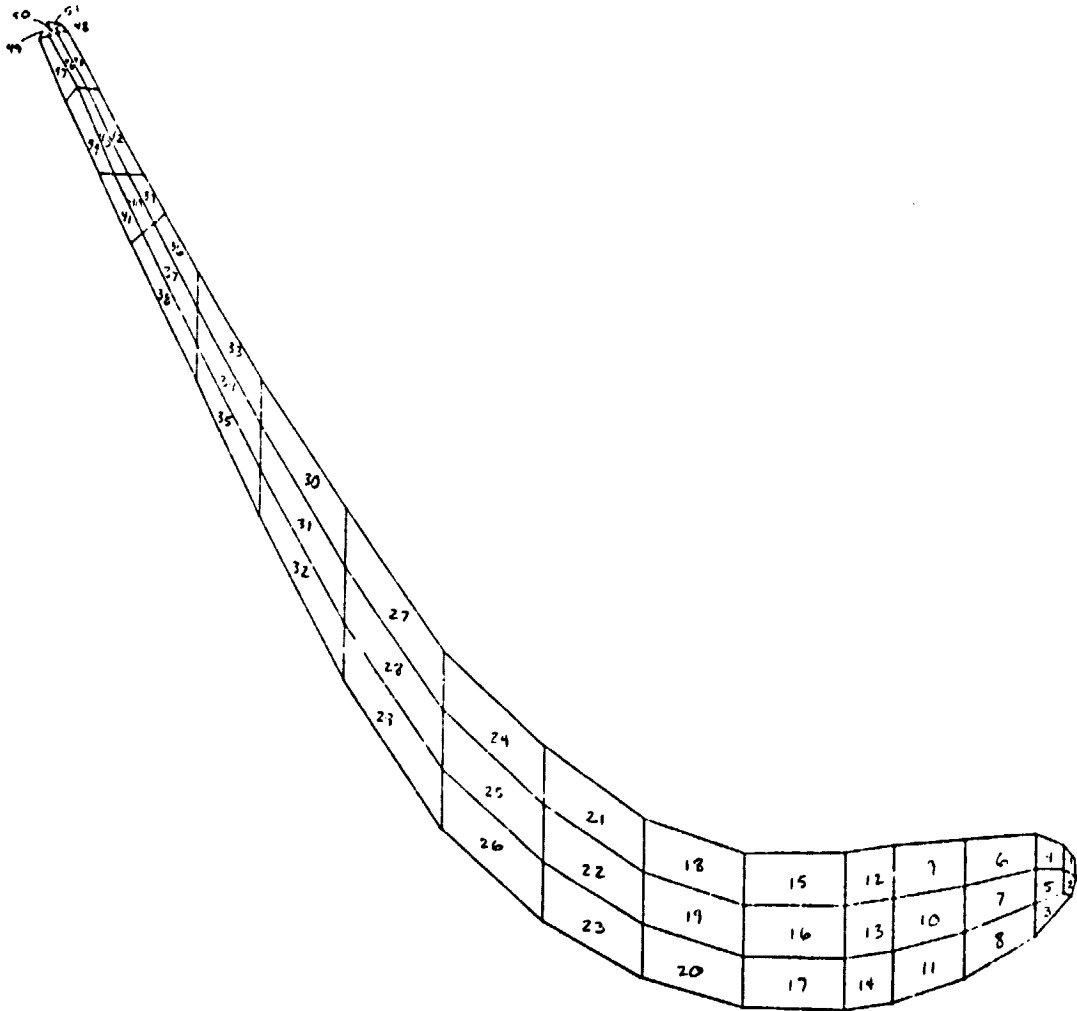

Fig. 2-2f F-2 Airfoil/Shank Element Layout

ORIGINAL PAGE IS
OF POOR QUALITY

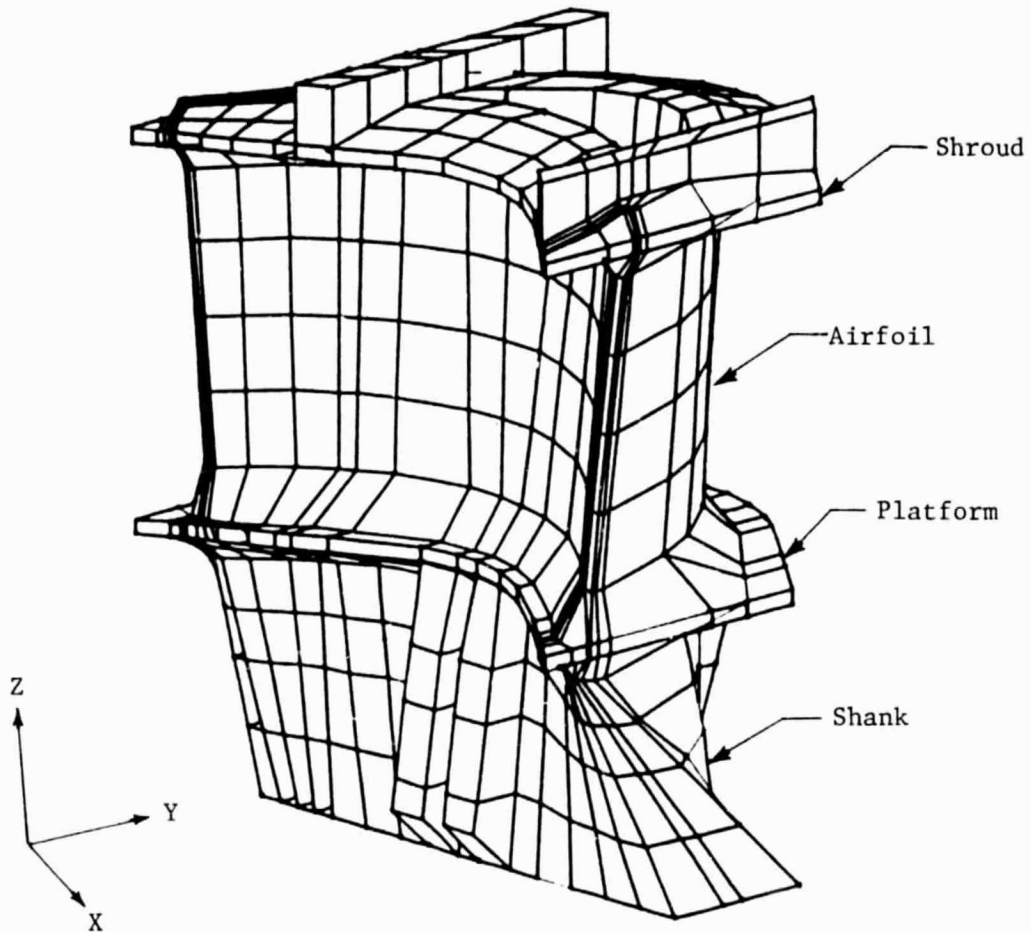

Fig. 2-3a HPOTP First Stage Turbine Blade (0-1) NASTRAN
Model (1137 Nodes, 618 Elements)

ORIGINAL PAGE IS
OF POOR QUALITY

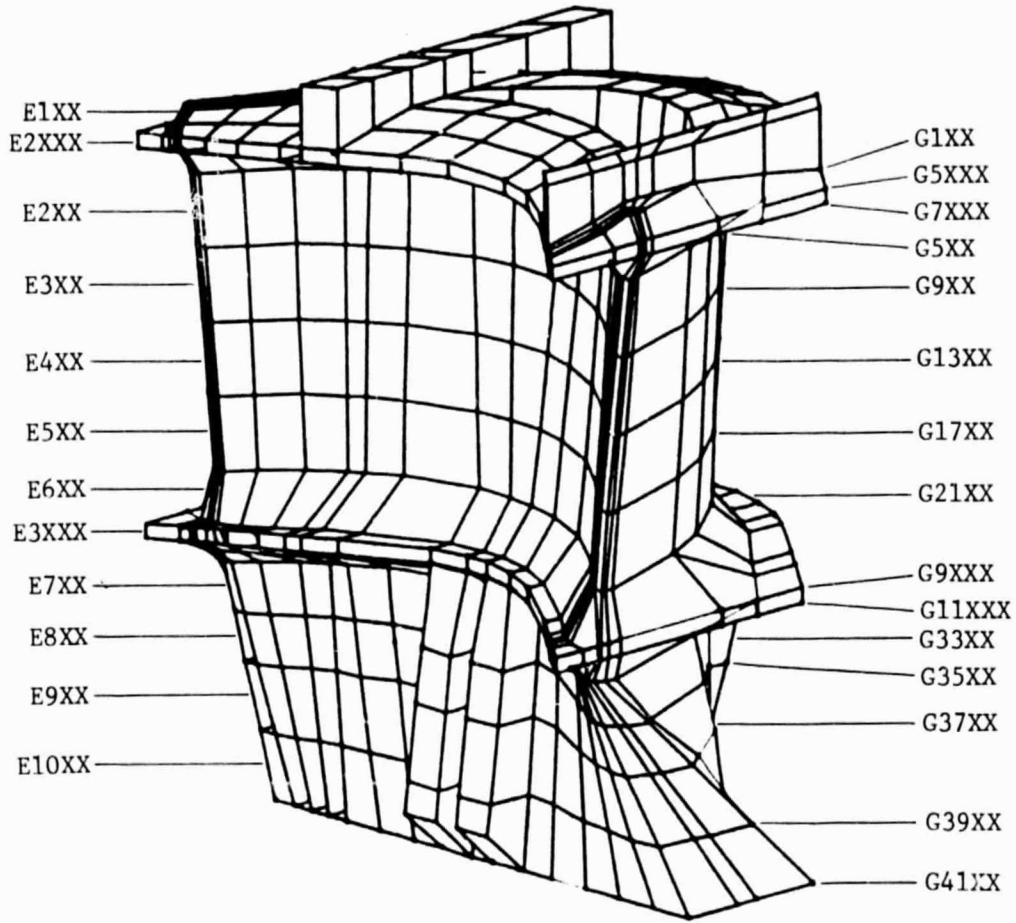

Fig. 2-3b 0-1 Element and Grid Prefixes

ORIGINAL PAGE 19
OF POOR QUALITY

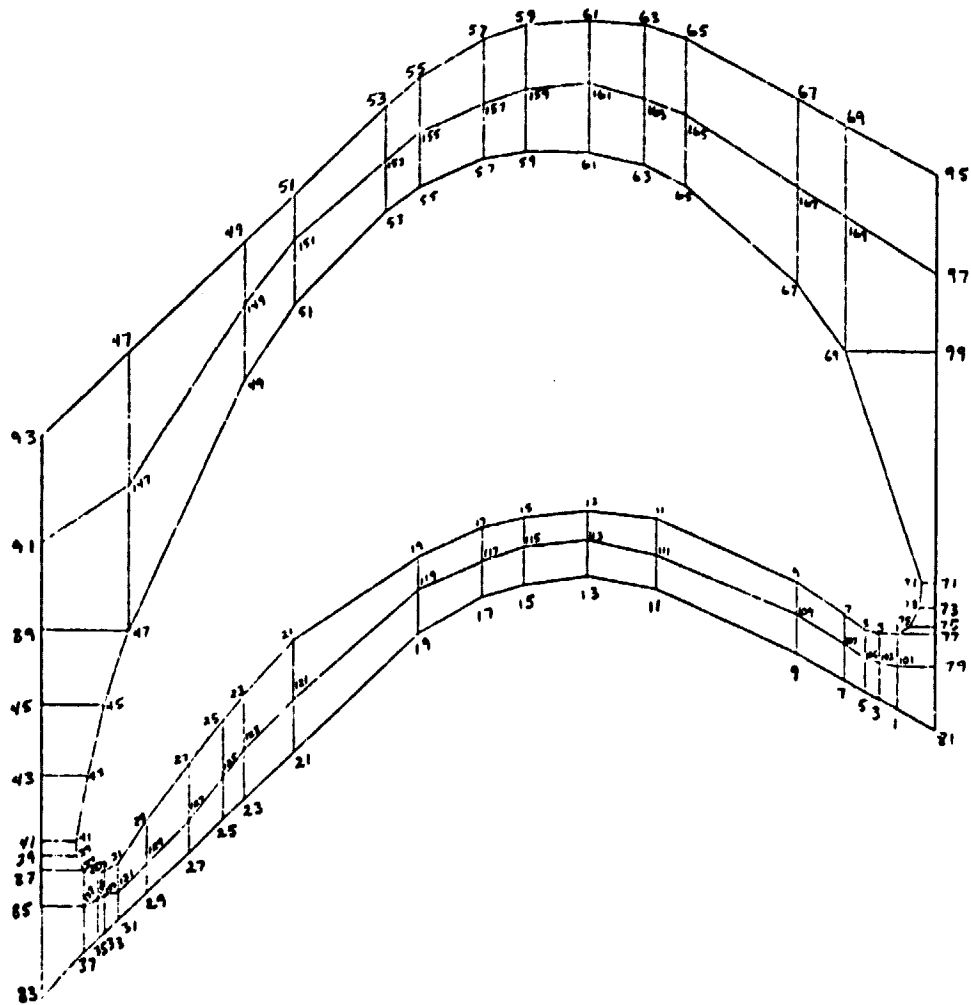

Fig. 2-3c 0-1 Shroud/Platform Grid Layout

ORIGINAL PAGE IS
OF POOR QUALITY

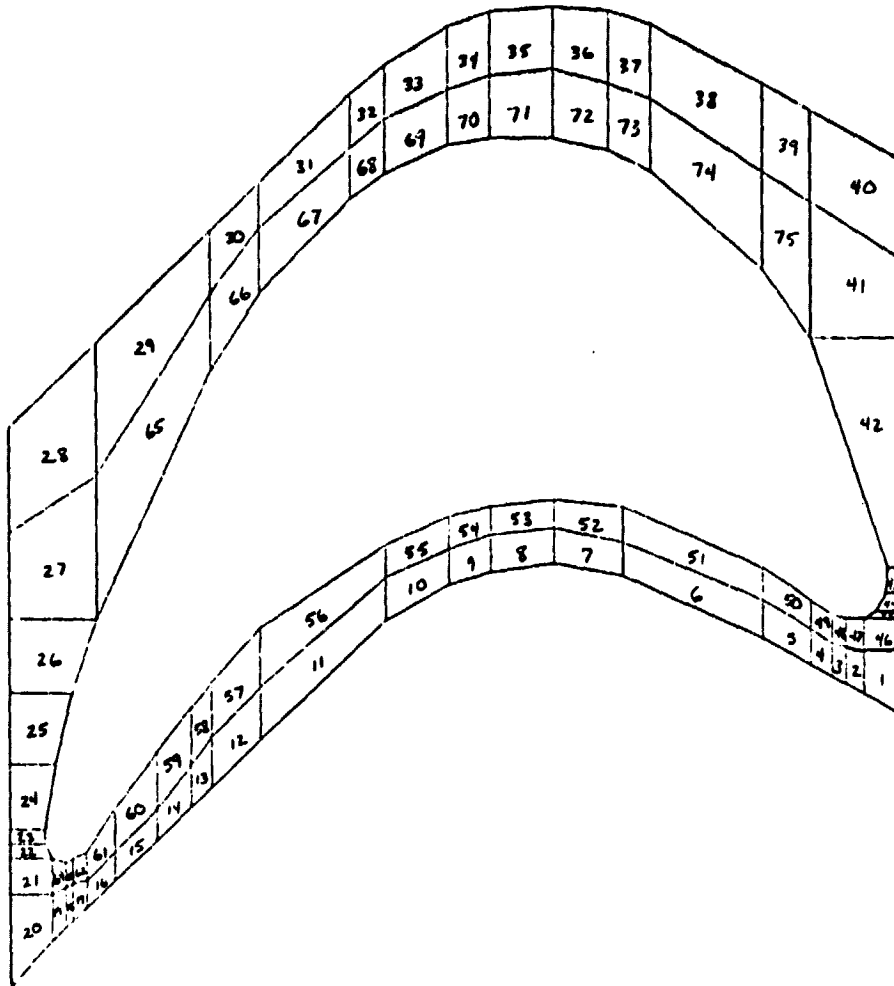

Fig. 2-3d 0-1 Shroud Platform/Element Layout

ORIGINAL PAGE 19
OF POOR QUALITY

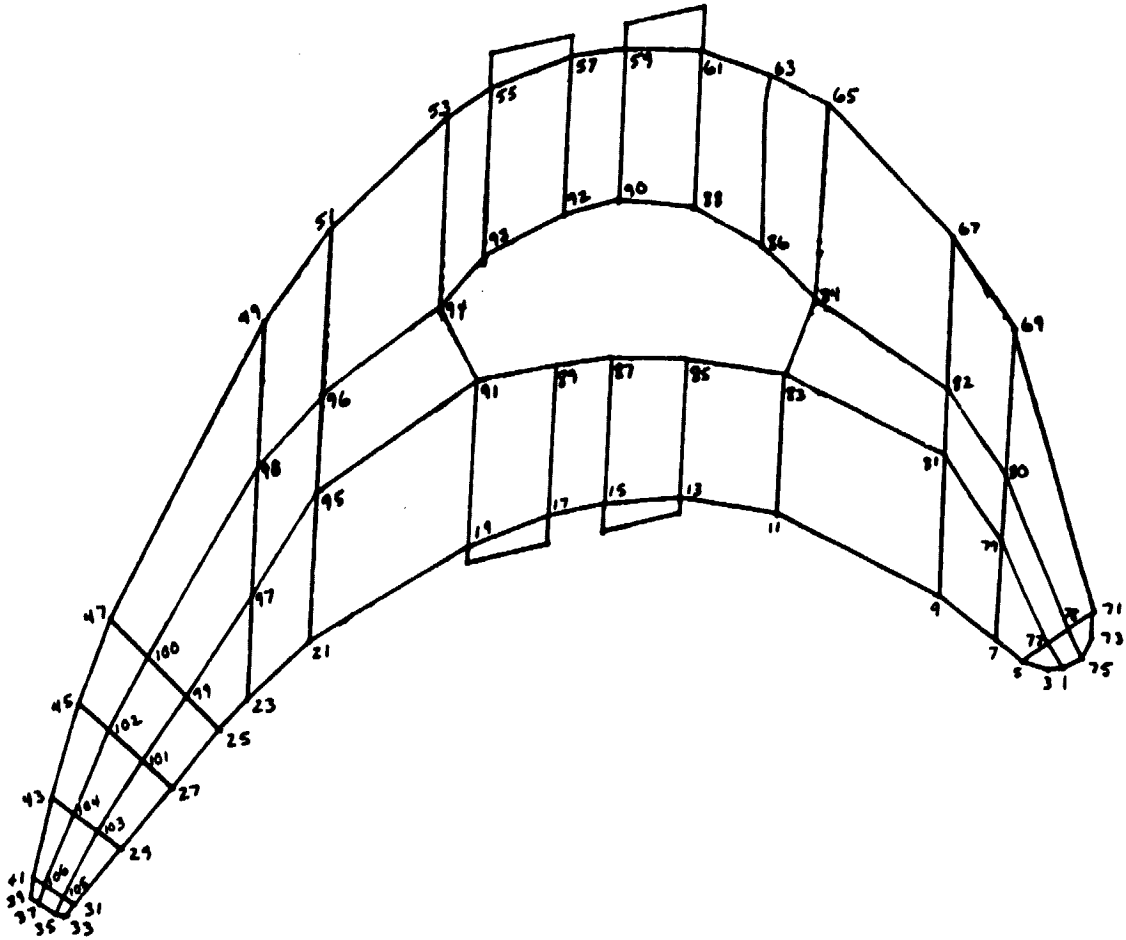

Fig. 2-3e 0-1 Airfoil/Shank Grid Layout

ORIGINAL PAGE IS
OF POOR QUALITY

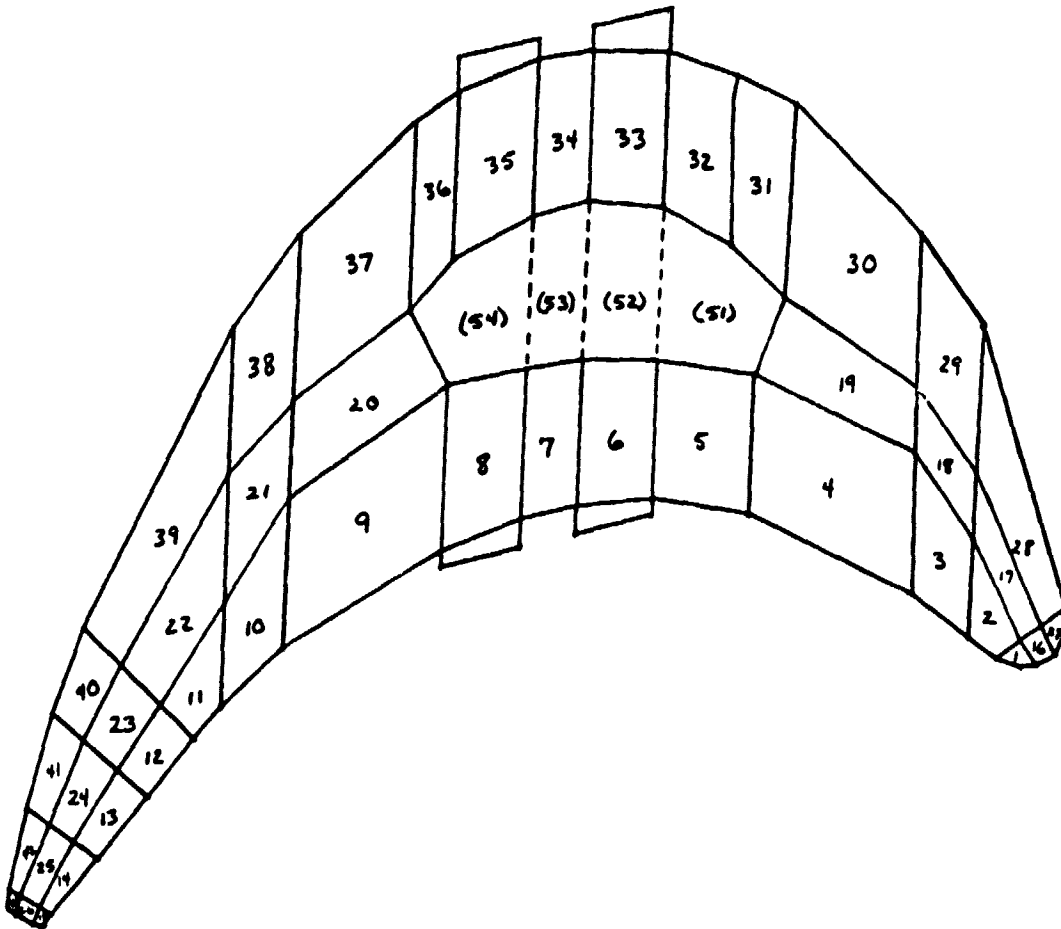

Fig. 2-3f 0-1 Airfoil/Shank Element Layout

ORIGINAL PAGE IS
OF POOR QUALITY

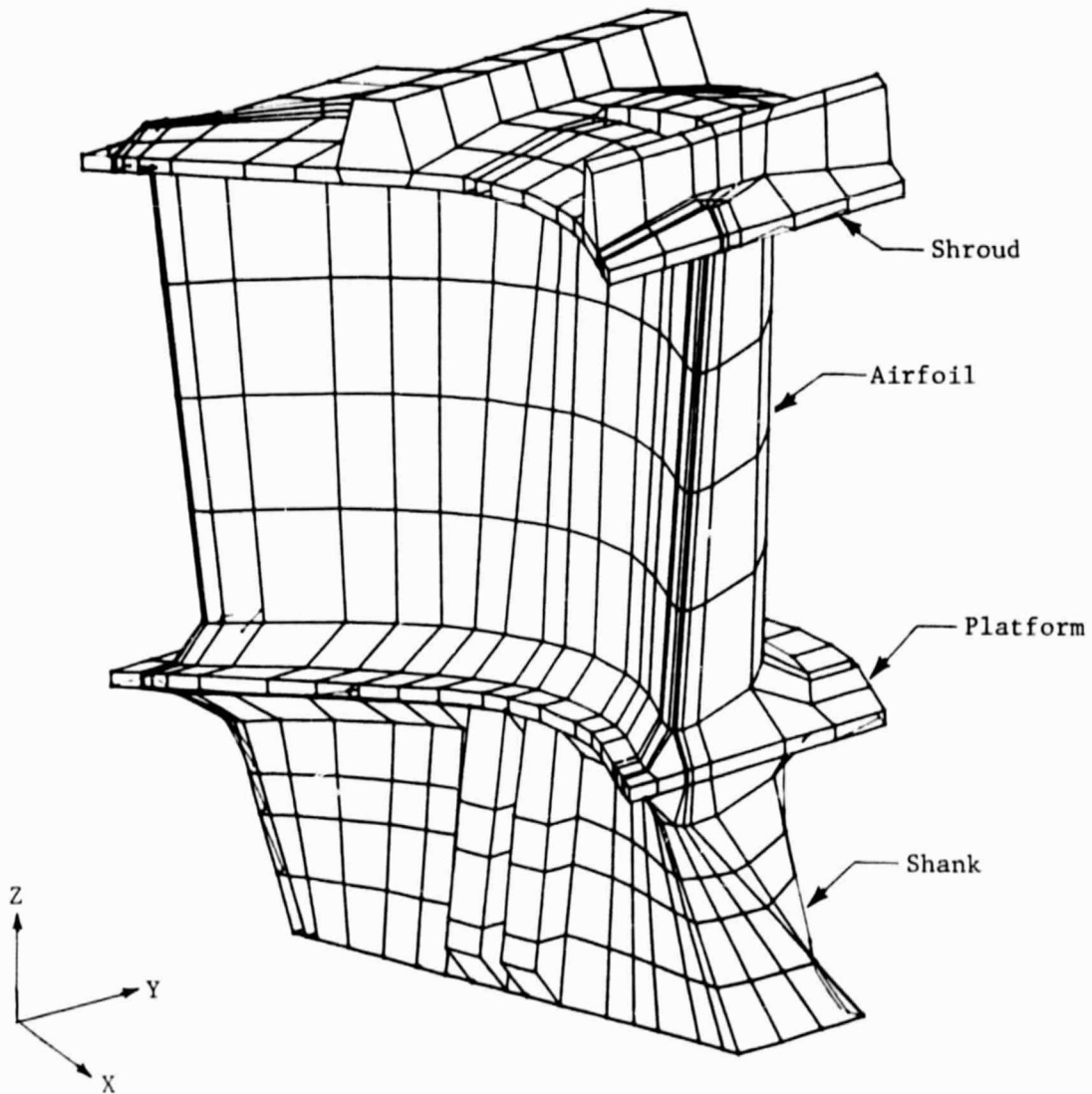

Fig. 2-4a HPOTP Stage Turbine Blade (0-2) NASTRAN Model
(1140 Nodes, 622 Elements)

ORIGINAL PAGE IS
OF POOR QUALITY

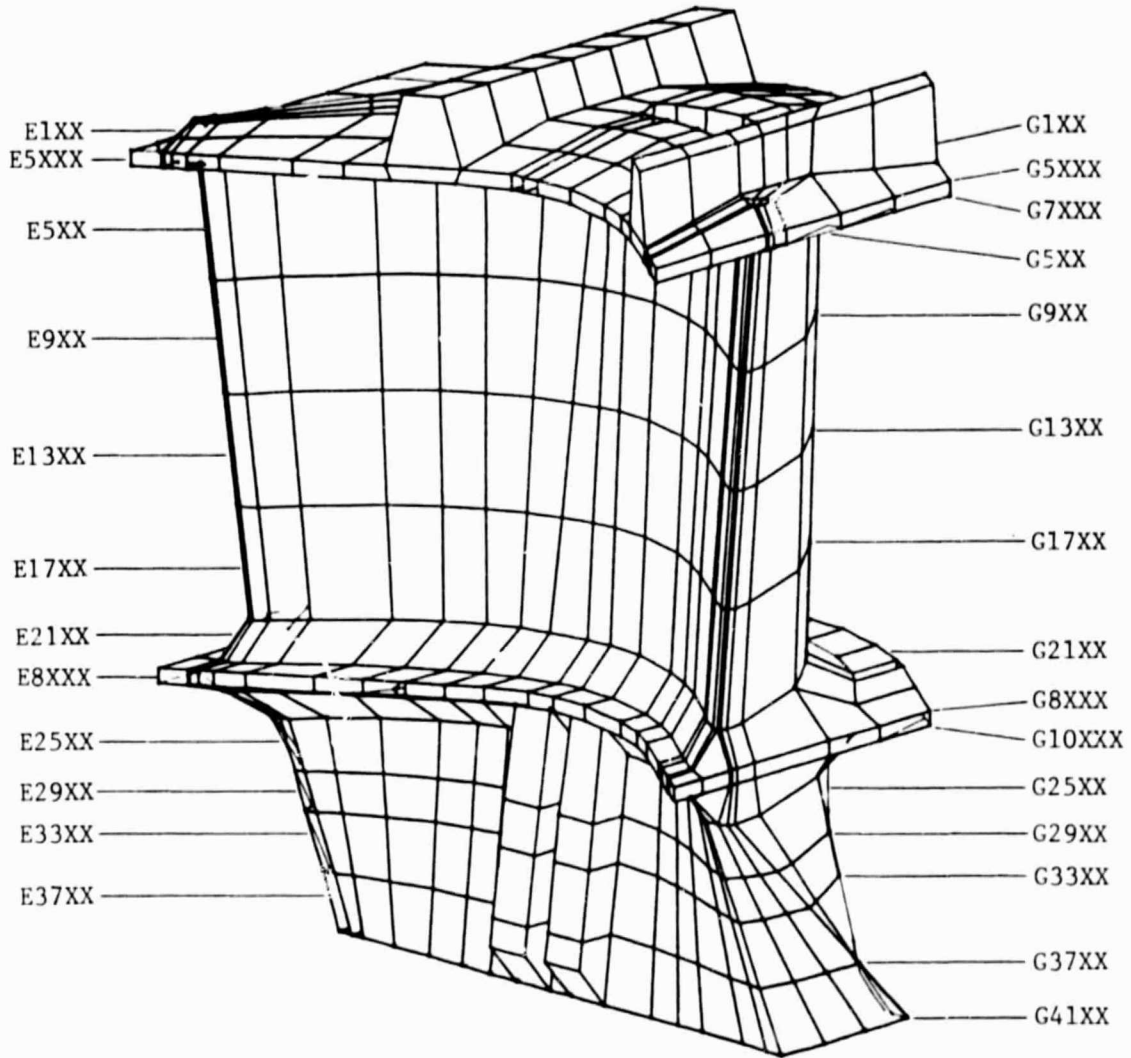

Fig. 2-4b 0-2 Element and Grid Prefixes

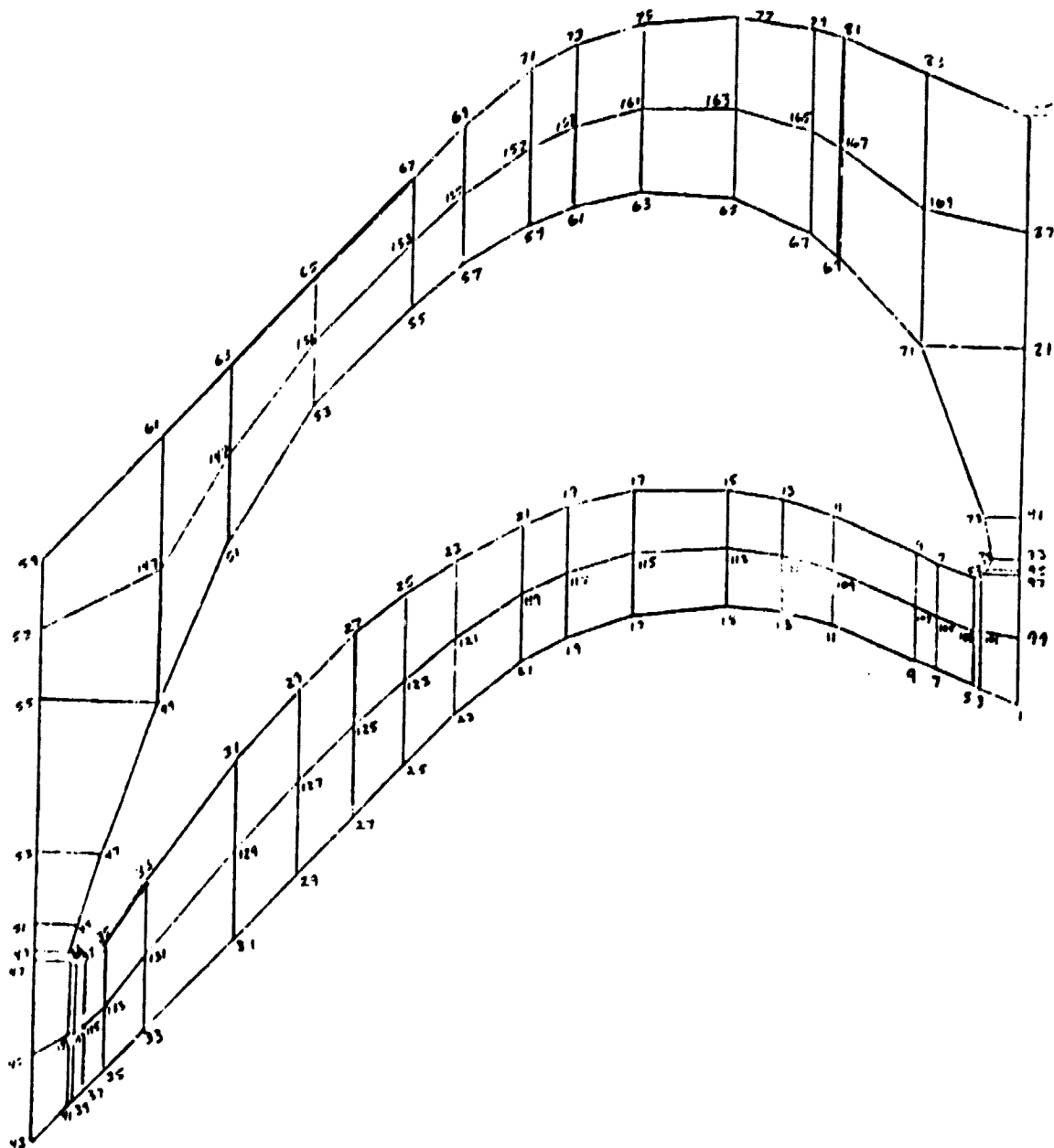

Fig. 2-4c 0-2 Shroud/Platform Grid Layout

ORIGINAL PAGE IS
OF POOR QUALITY

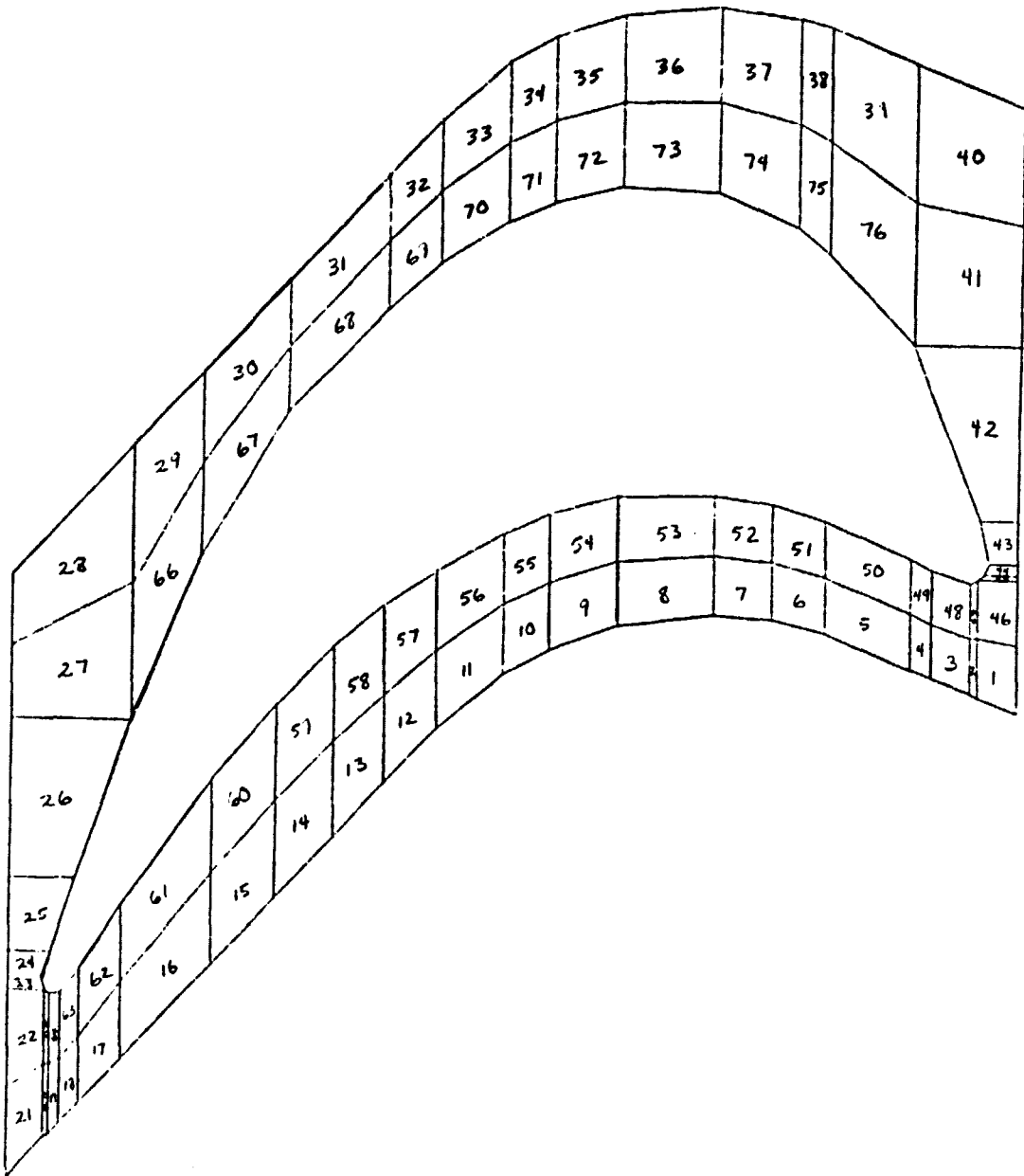

Fig. 2-4d 0-2 Shroud/Platform Element Layout

ORIGINAL PAGE 19
OF POOR QUALITY

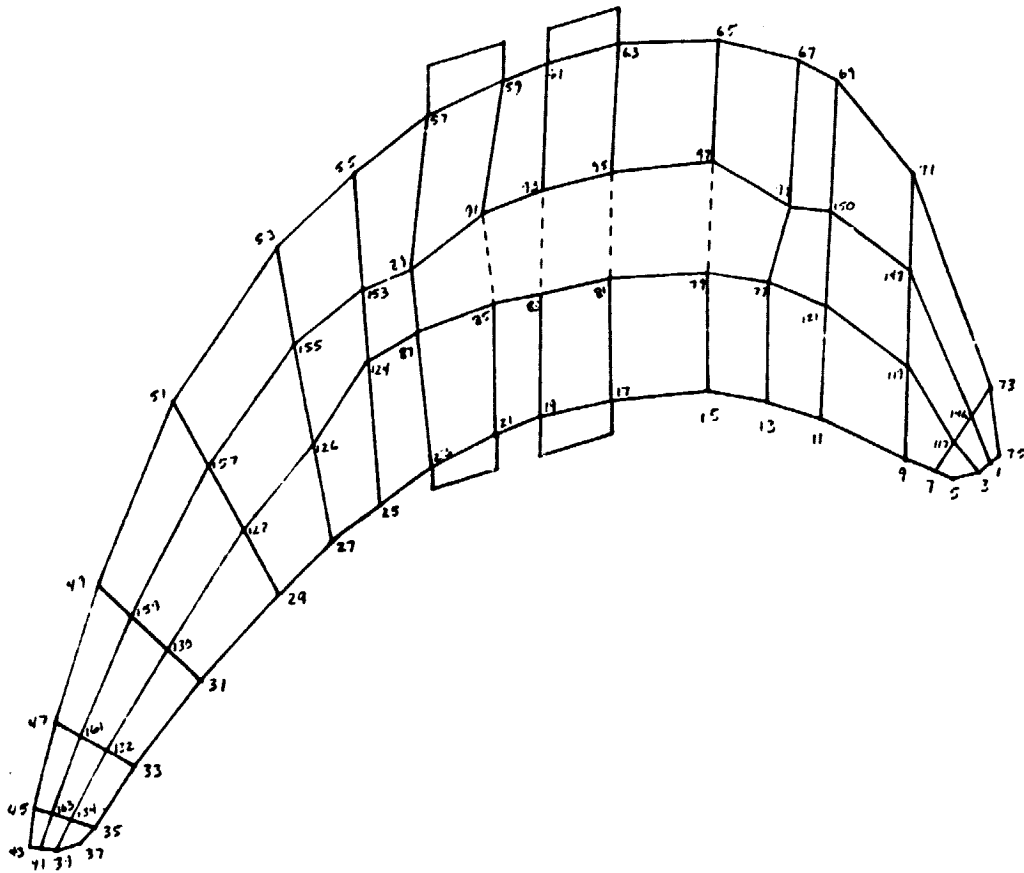

Fig. 2-4e 0-2 Airfoil/Shank Grid Layout

ORIGINAL PAGE IS
OF POOR QUALITY

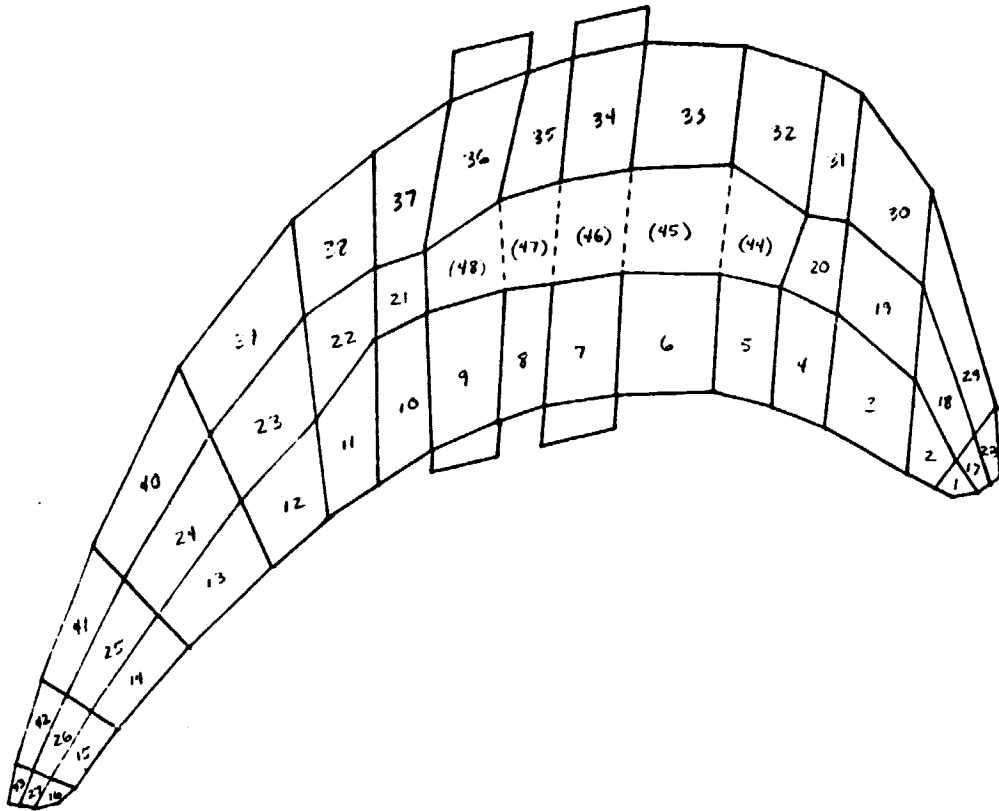

Fig. 2-4f 0-2 Airfoil/Shank Element Layout

2.2 HPFTP FIRST STAGE TURBINE BLADE DYNAMICS

The first 10 normal modes are summarized in Table 2-1 and Figs. 2-5 through 2-14. The Campbell diagram is shown in Fig. 2-15.

Table 2-1
HPFTP FIRST STAGE TURBINE BLADE NORMAL MODES

<u>Mode</u>	<u>Frequency (Hz)</u>
1	4642
2	8239
3	12186
4	15959
5	19002
6	21469
7	23099
8	27832
9	31961
10	33210

ORIGINAL PAGE IS
OF POOR QUALITY

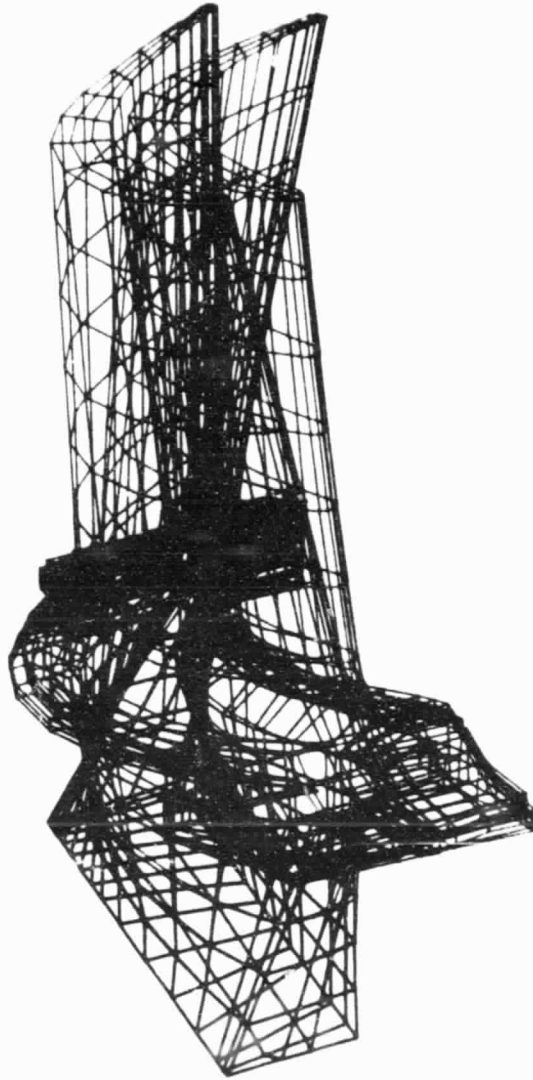

Fig. 2-5 Model F-1, Mode 1, Freq 4642

ORIGINAL PAGE IS
OF POOR QUALITY



Fig. 2-6 Model F-1, Mode 2, Freq 8239

ORIGINAL PAGE IS
OF POOR QUALITY



Fig. 2-7 Model F-1, Mode 3, Freq 12186

ORIGINAL PAGE IS
OF POOR QUALITY



Fig. 2-8 Model F-1, Mode 4, Freq 15959

ORIGINAL PAGE IS
OF POOR QUALITY

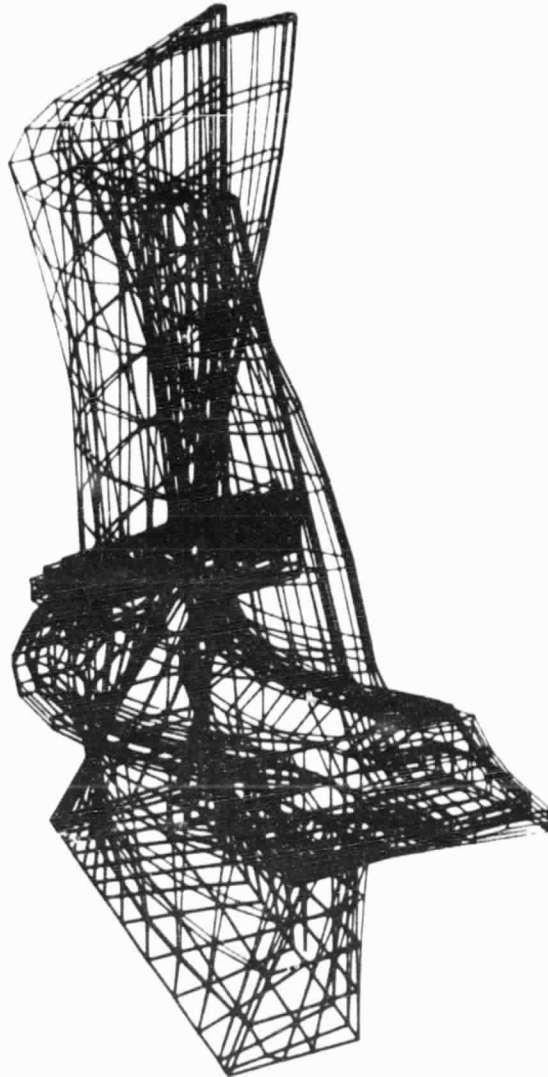

Fig. 2-9 Model F-1, Mode 5, Freq 19002

ORIGINAL PAGE 19
OF POOR QUALITY

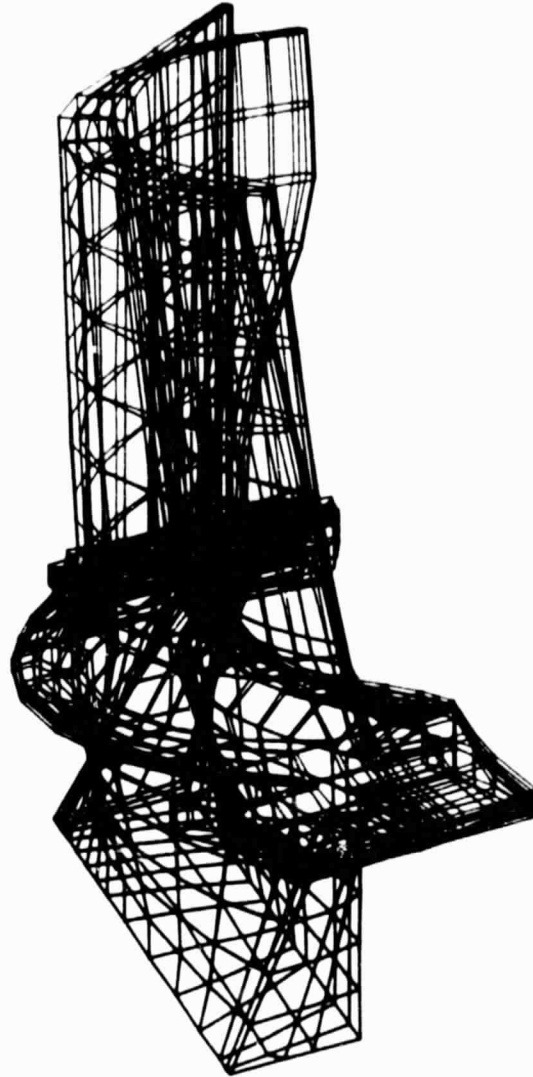

Fig. 2-10 Model F-1, Mode 6, Freq 21469

ORIGINAL PAGE 19
OF POOR QUALITY

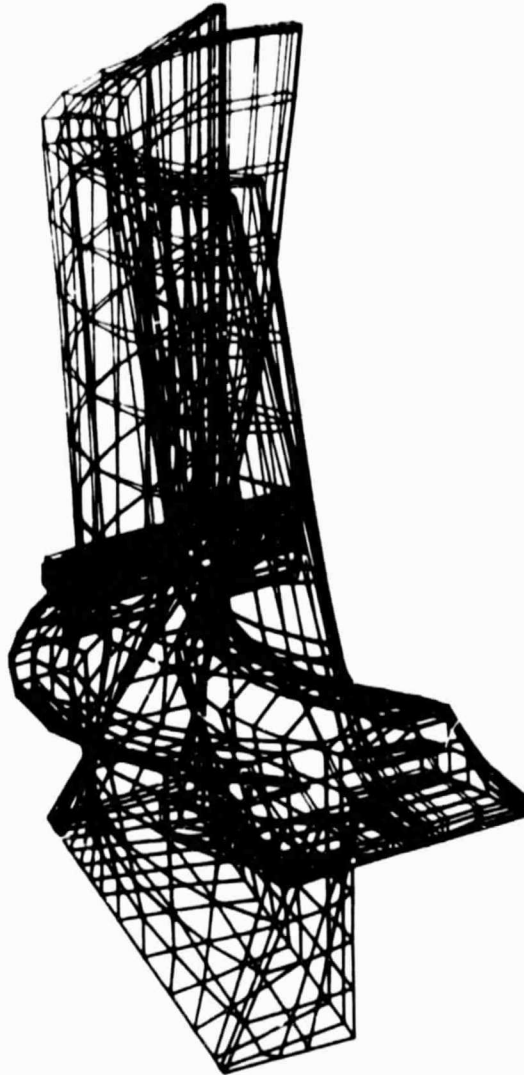

Fig. 2-11 Model F-1, Mode 7, Freq 23099

ORIGINAL PAGE IS
OF POOR QUALITY



Fig. 2-12 Model F-1, Mode 8, Freq 27832

ORIGINAL PAGE IS
OF POOR QUALITY



Fig. 2-13 Model F-1, Mode 9, Freq 31961

ORIGINAL PAGE IS
OF POOR QUALITY

LMSC-HREC TR D867333-11



Fig. 2-14 Model F-1, Mode 10, Freq 33210

ORIGINAL PAGE IS
OF POOR QUALITY

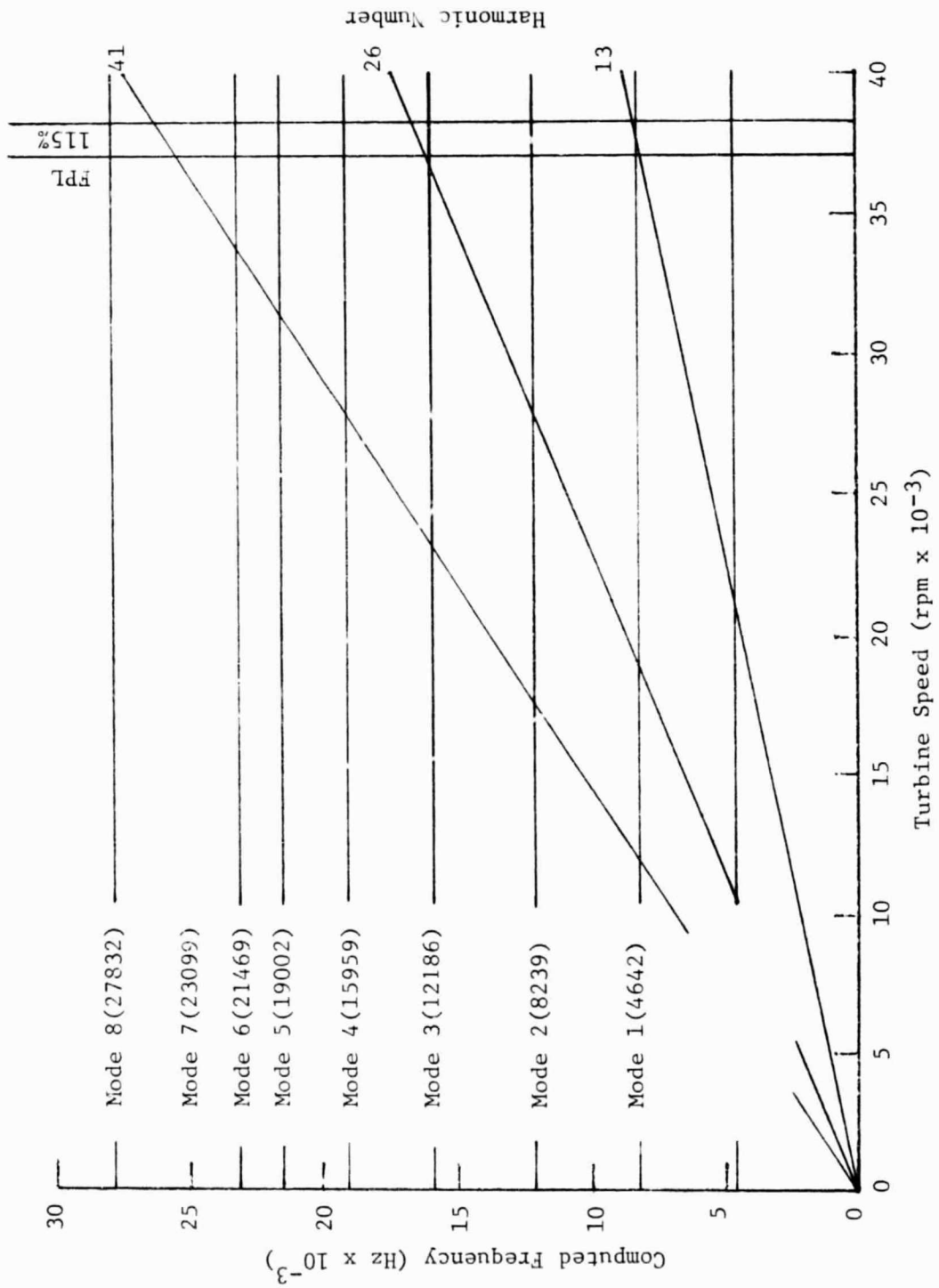

Fig. 2-15 HPFTP First Stage Turbine Blade Campbell Diagram

2.3 HPFTP SECOND STAGE TURBINE BLADE DYNAMICS

The first ten normal modes are summarized in Table 2-2 and Figs. 2-16 through 2-25. The Campbell diagram is shown in Fig. 2-26

Table 2-2
HPFTP FIRST STAGE TURBINE BLADE NORMAL MODES

<u>Mode</u>	<u>Frequency (Hz)</u>
1	4495
2	7815
3	11670
4	16625
5	19189
6	24720
7	29160
8	29760
9	32209
10	32773

ORIGINAL PAGE IS
OF POOR QUALITY

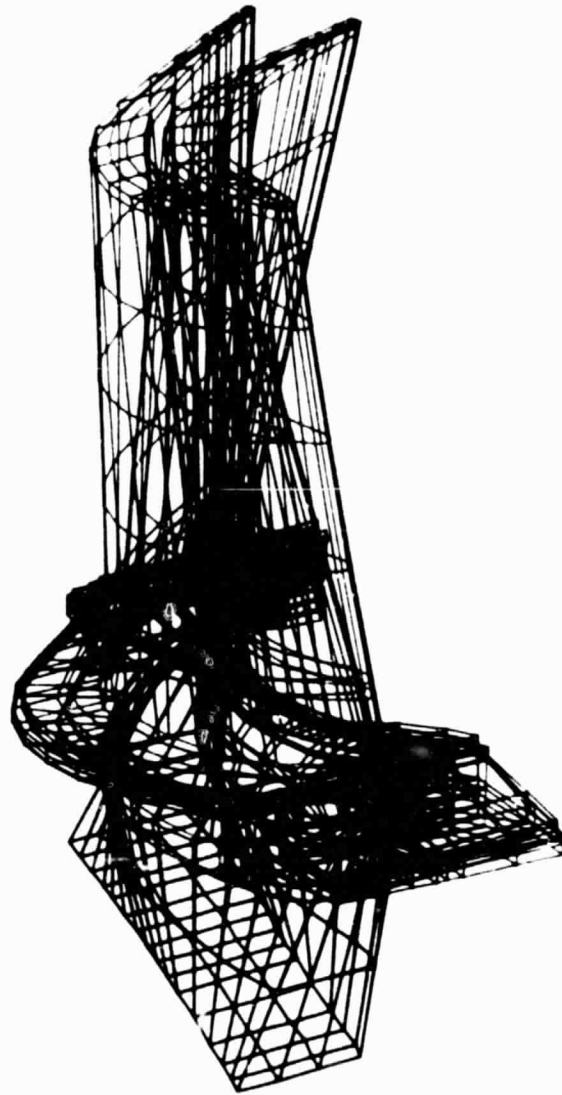

Fig. 2-16 Model F-2, Mode 1, Freq 4495

ORIGINAL PAGE IS
OF POOR QUALITY

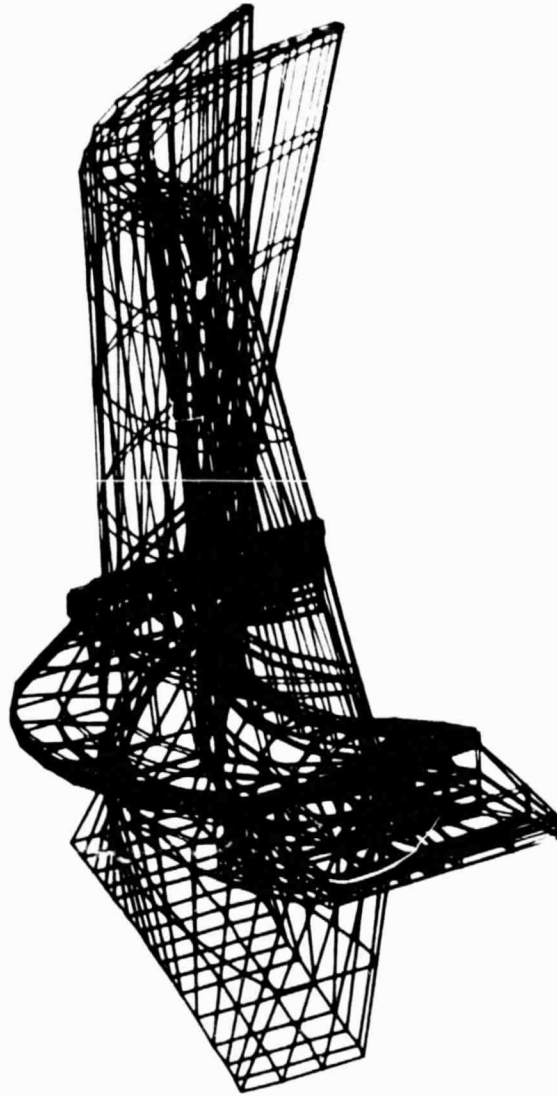

Fig. 2-17 Model F-2, Mode 2, Freq 7815

ORIGINAL PAGE IS
OF POOR QUALITY



Fig. 2-18 Model F-2, Mode 3, Freq 11670

ORIGINAL PAGE IS
OF POOR QUALITY

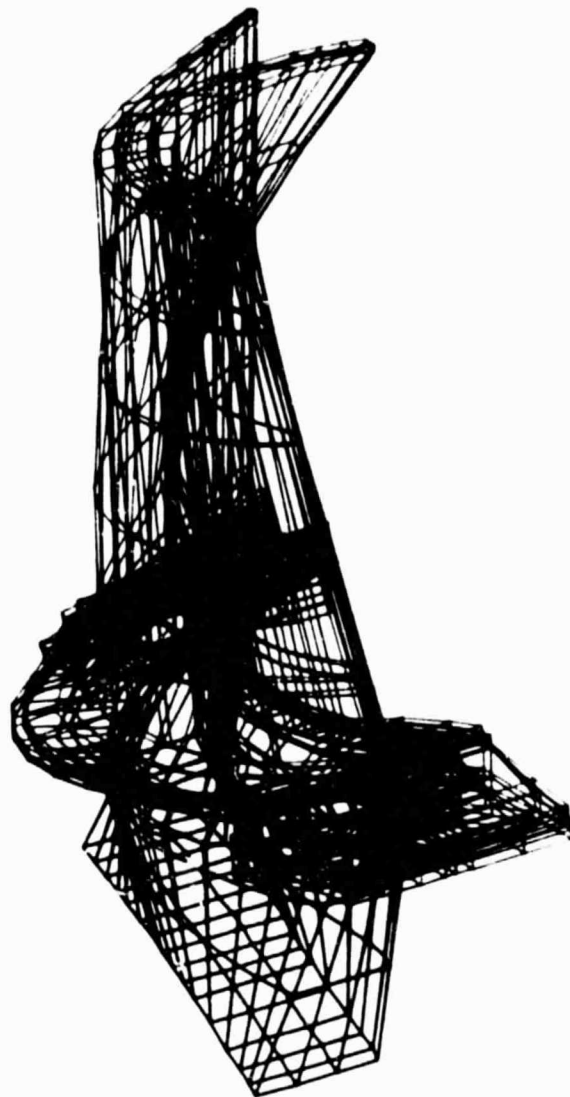

Fig. 2-19 Model F-2, Mode 4, Freq 16625

ORIGINAL PAGE IS
OF POOR QUALITY

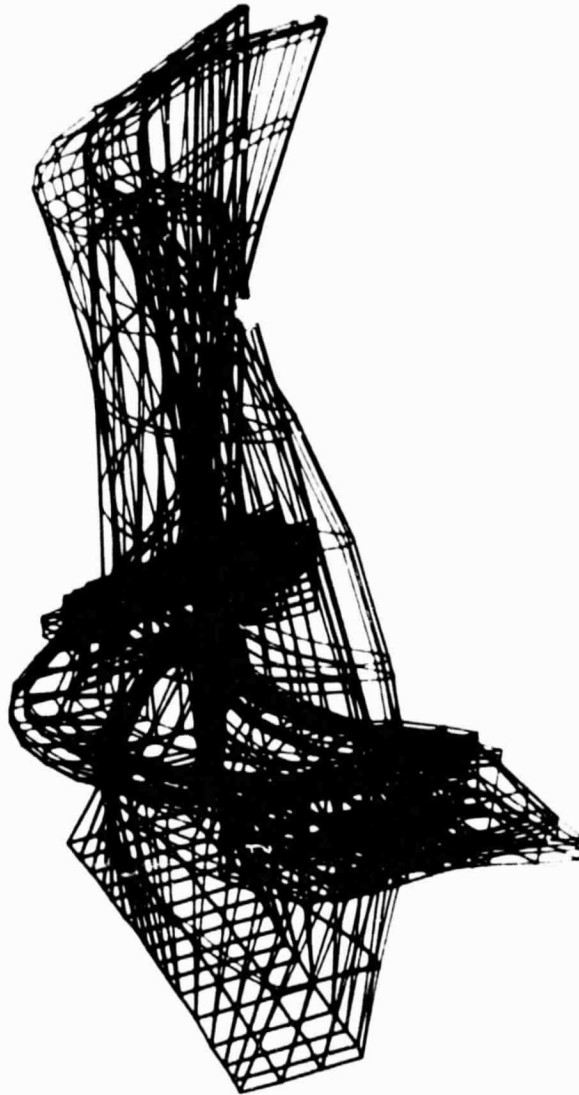

Fig. 2-20 Model F-2, Mode 5, Freq 19189

ORIGINAL PAGE IS
OF POOR QUALITY.



Fig. 2-21 Model F-2, Mode 6, Freq 24720

ORIGINAL COPY IS
OF POOR QUALITY

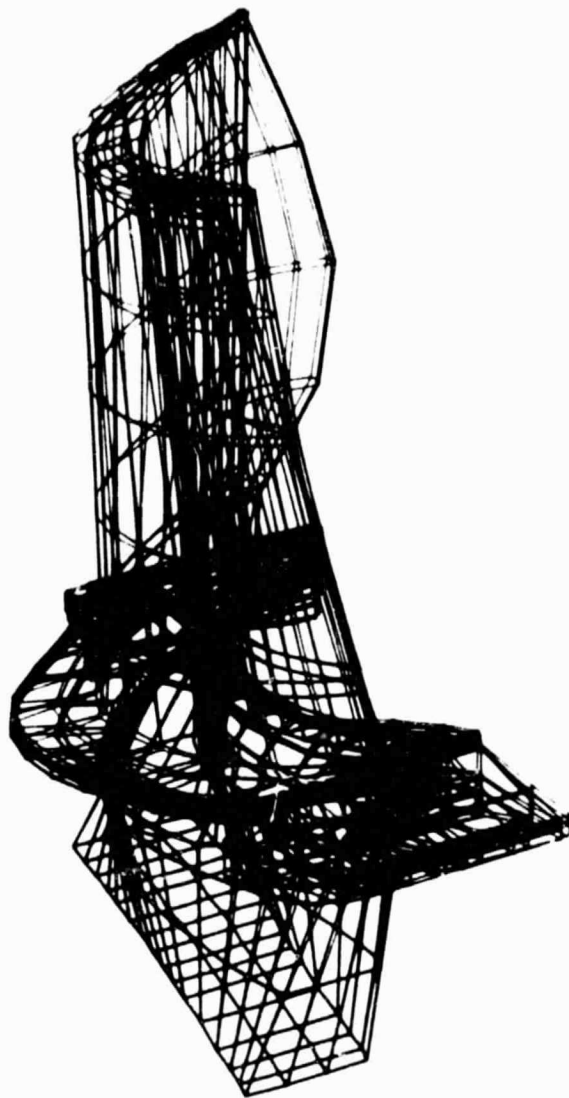

Fig. 2-22 Model F-2, Mode 7, Freq 29160

ORIGINAL PAGE IS
OF POOR QUALITY



Fig. 2-23 Model F-2, Mode 8, Freq 29760

ORIGINAL PAGE IS
OF POOR QUALITY

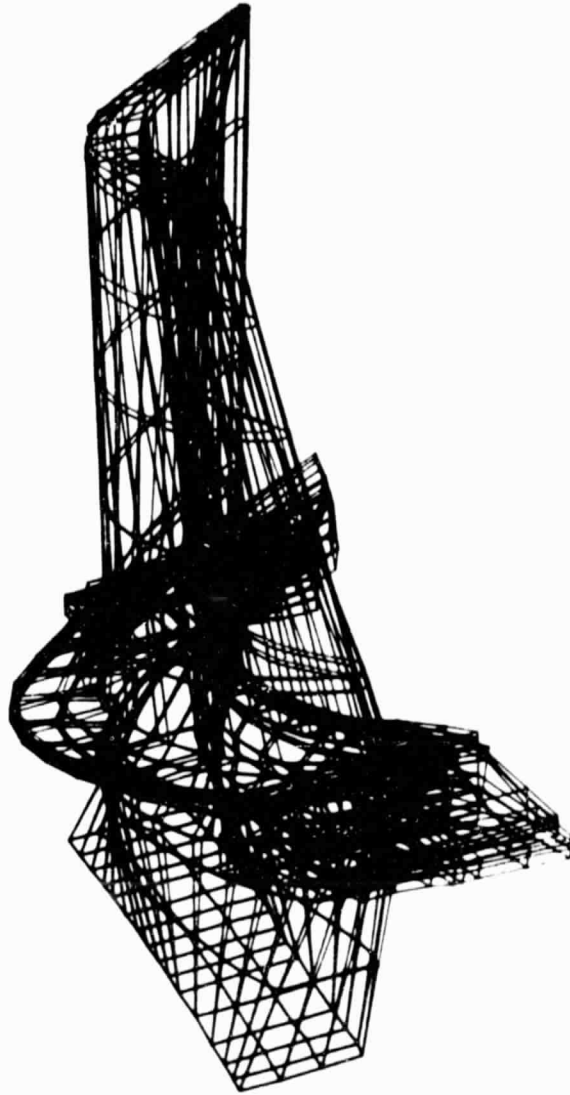

Fig. 2-24 Model F-2, Mode 9, Freq 32209

ORIGINAL PAGE IS
OF POOR QUALITY

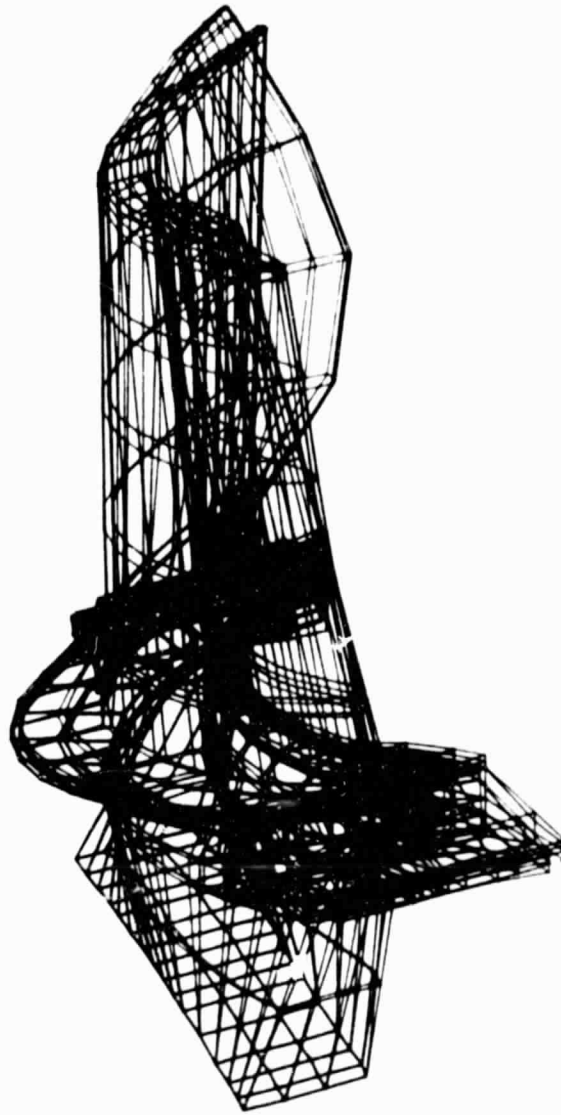

Fig. 2-25 Model F-2, Mode 10, Freq 32773

ORIGINAL PAGE IS
OF POOR QUALITY

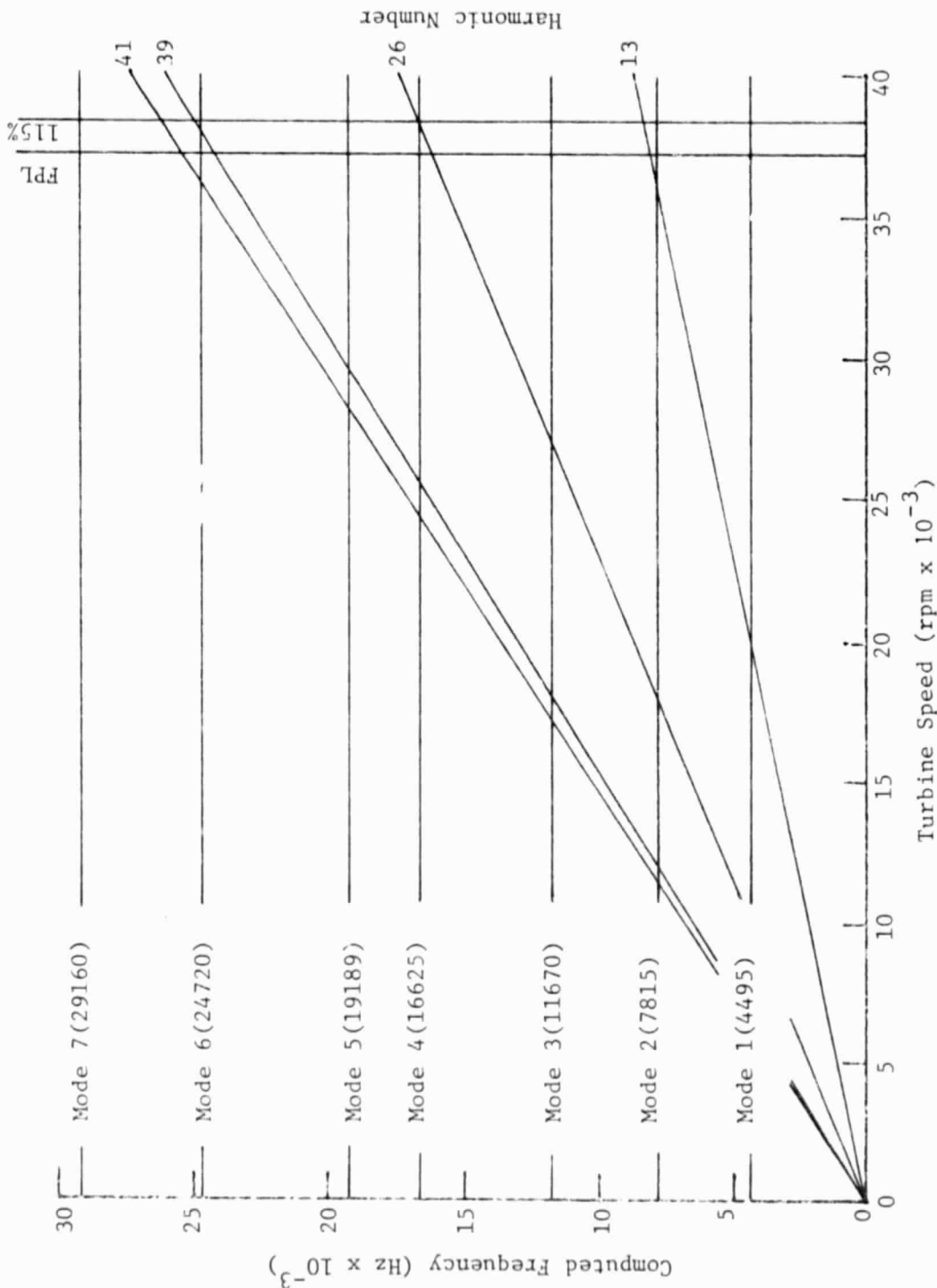

Fig. 2-26 HPFTP Second Stage Turbine Blade Campbell Diagram

2.4 HPOTP FIRST STAGE TURBINE BLADE DYNAMICS

The first ten normal modes are summarized in Table 2-3 and Figs. 2-27 through 2-37.

Table 2-3
HPOTP FIRST STAGE TURBINE BLADE NORMAL MODES

<u>Mode</u>	<u>Frequency (Hz)</u>
1	6626
2	12335
3	14848
4	29902
5	35521
6	41743
7	43037
8	51516
9	60815
10	62167

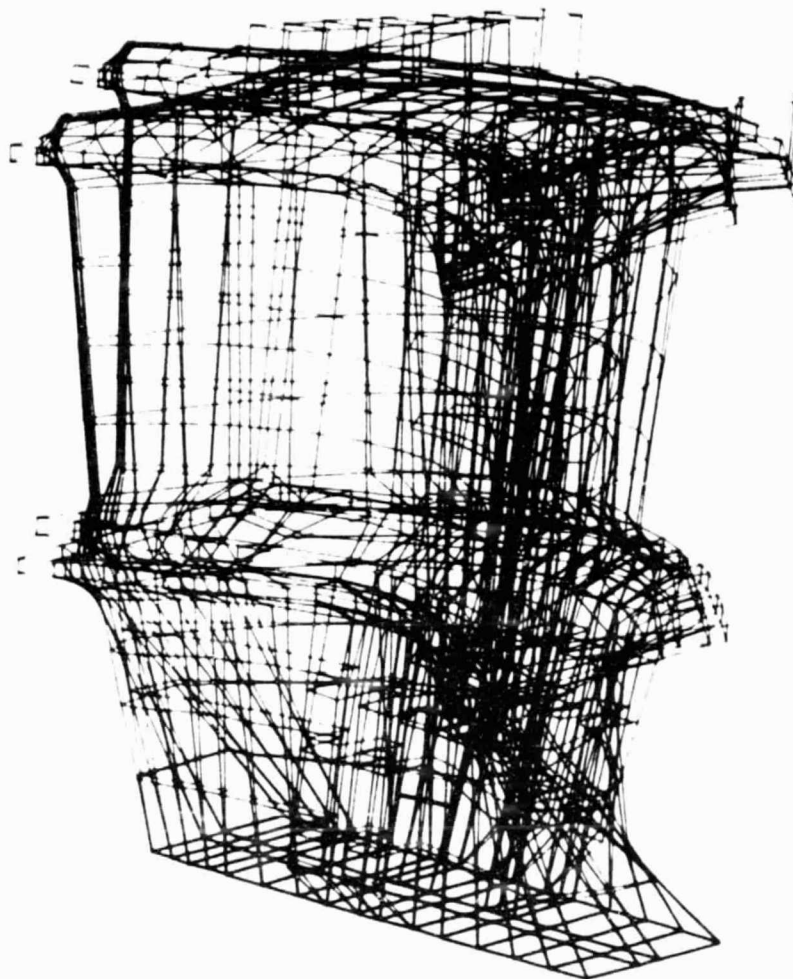

Fig. 2-27 Model 0-1, Mode 1, Freq 6626

ORIGINAL PAGE IS
OF POOR QUALITY

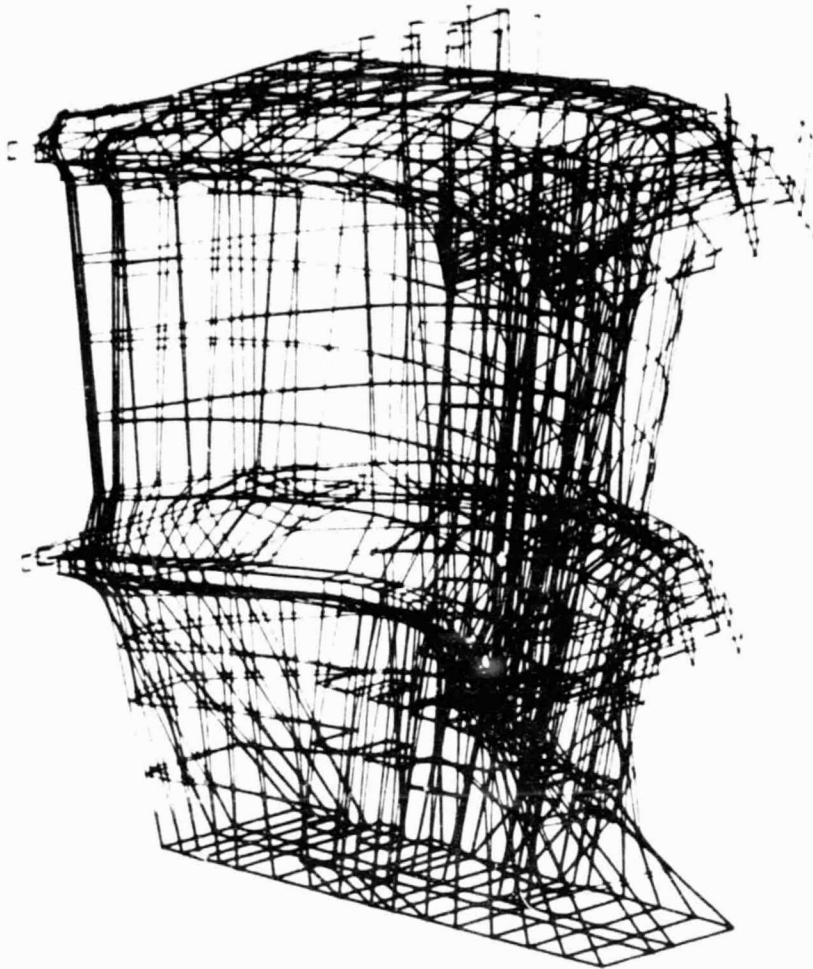

Fig. 2-28 Model 0-1, Mode 2, Freq 12335

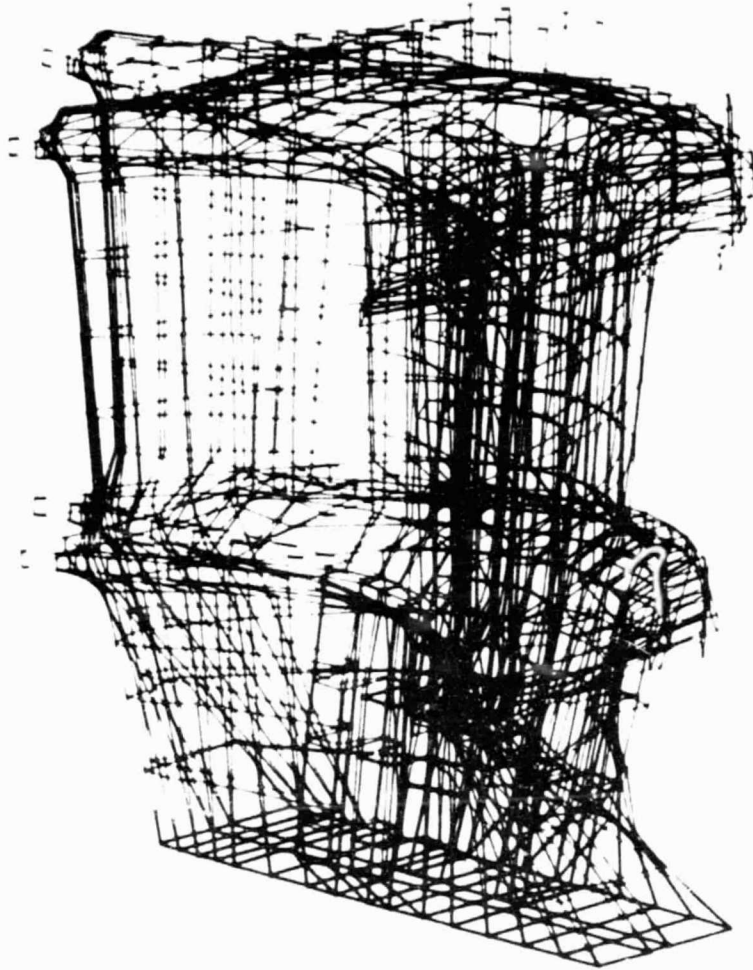

Fig. 2-29 Model 0-1, Mode 3, Freq 14848

ORIGINAL PAGE IS
OF POOR QUALITY

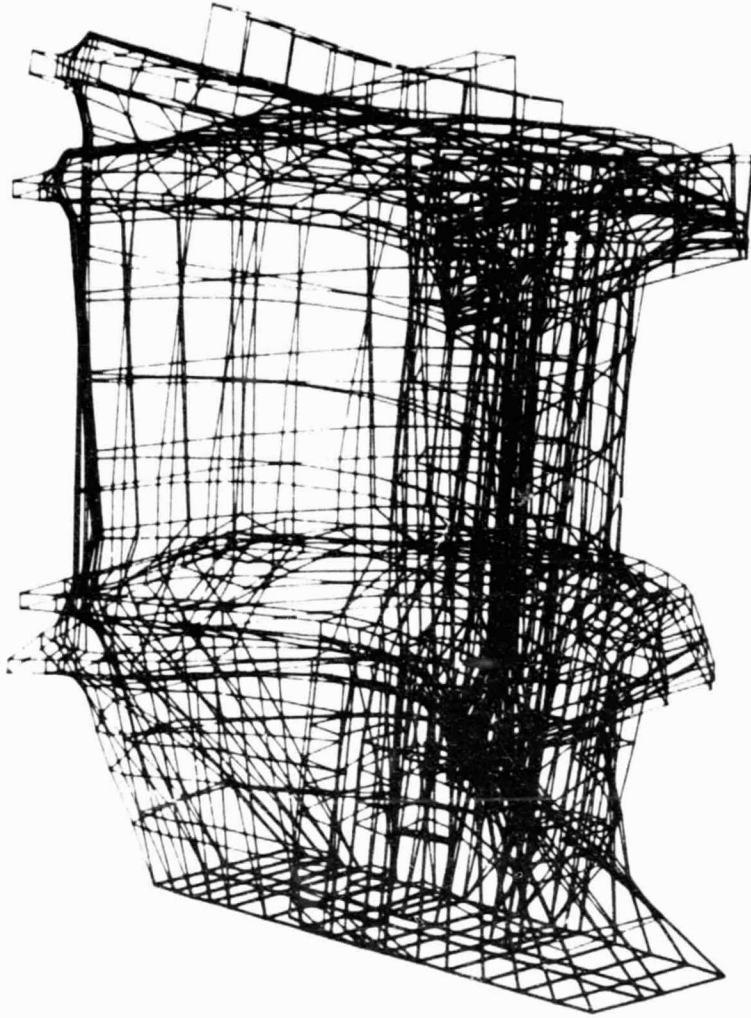

Fig. 2-30 Model 0-1, Mode 4, Freq 29902

ORIGINAL PAGE IS
OF POOR QUALITY

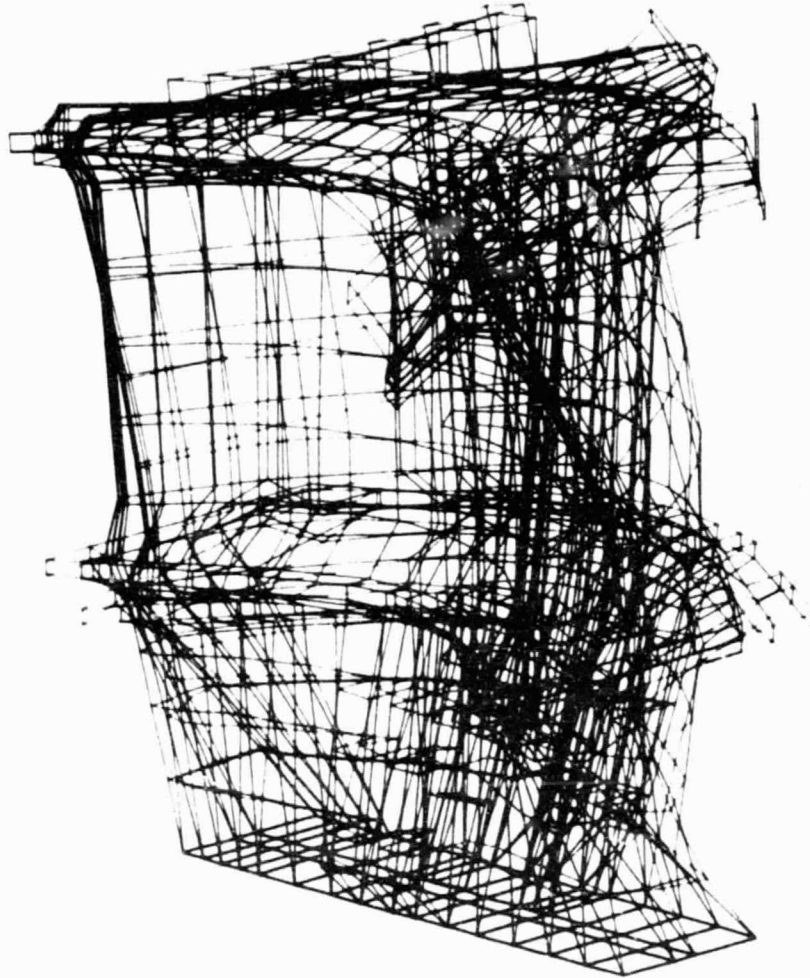

Fig. 2-31 Model 0-1, Mode 5, Freq 35521

ORIGINAL PAGE IS
OF POOR QUALITY

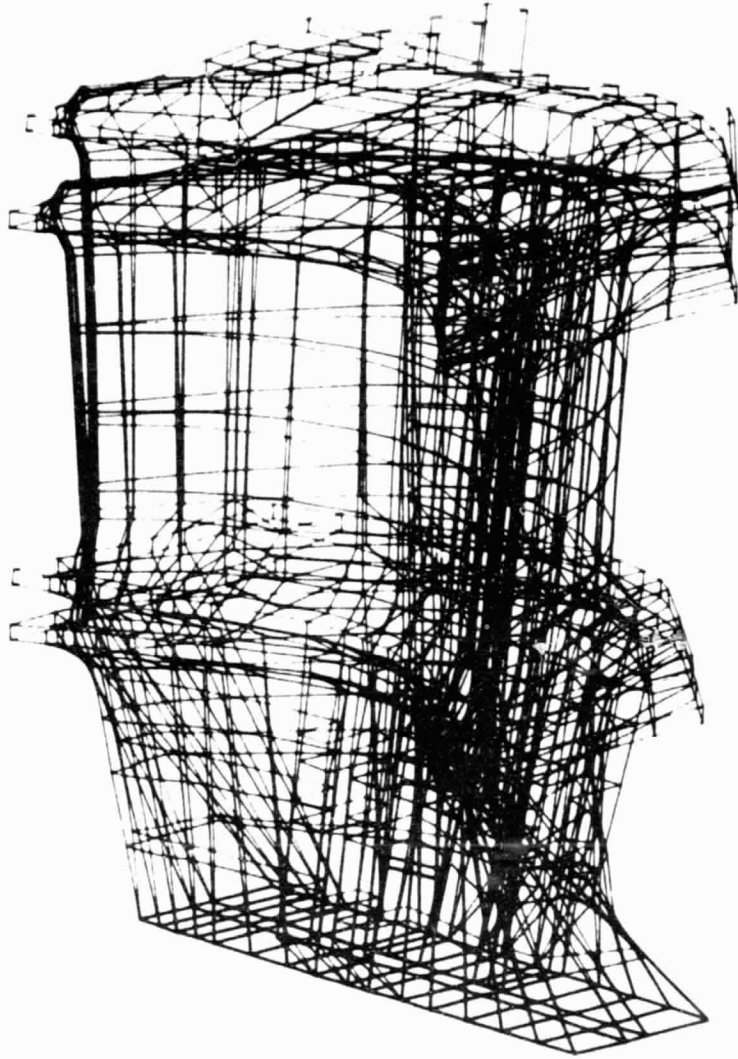

Fig. 2-32 Model 0-1, Mode 6, Freq 41743

ORIGINAL PAGE IS
OF POOR QUALITY.

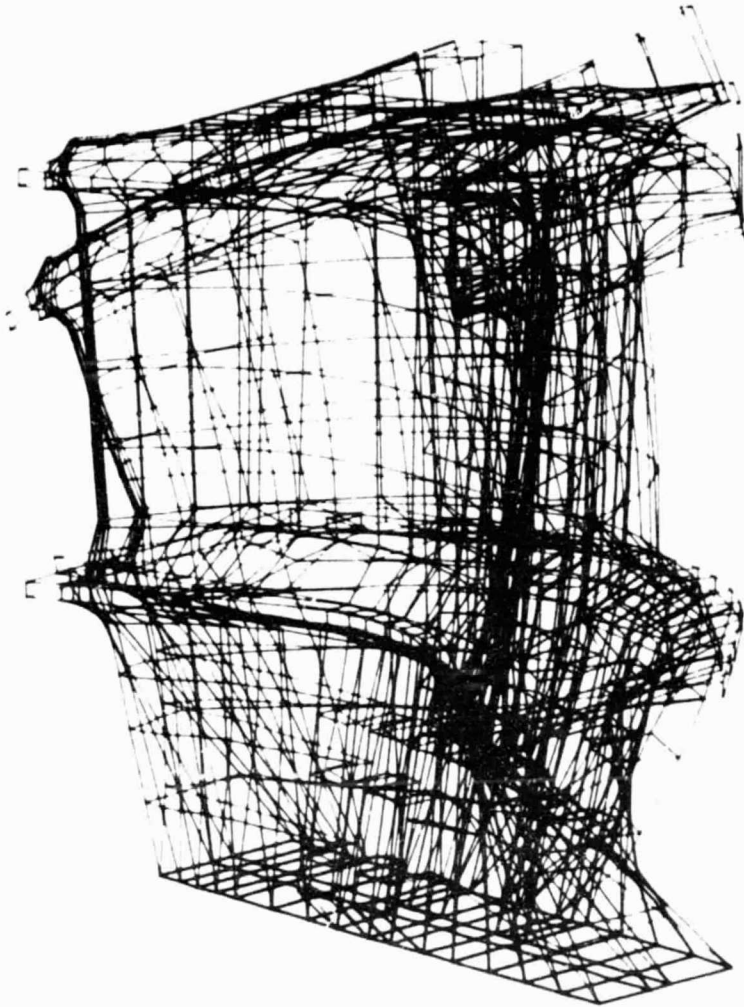

Fig. 2-33 Model 0-1, Mode 7, Freq 43037

ORIGINAL PAGE IS
OF POOR QUALITY

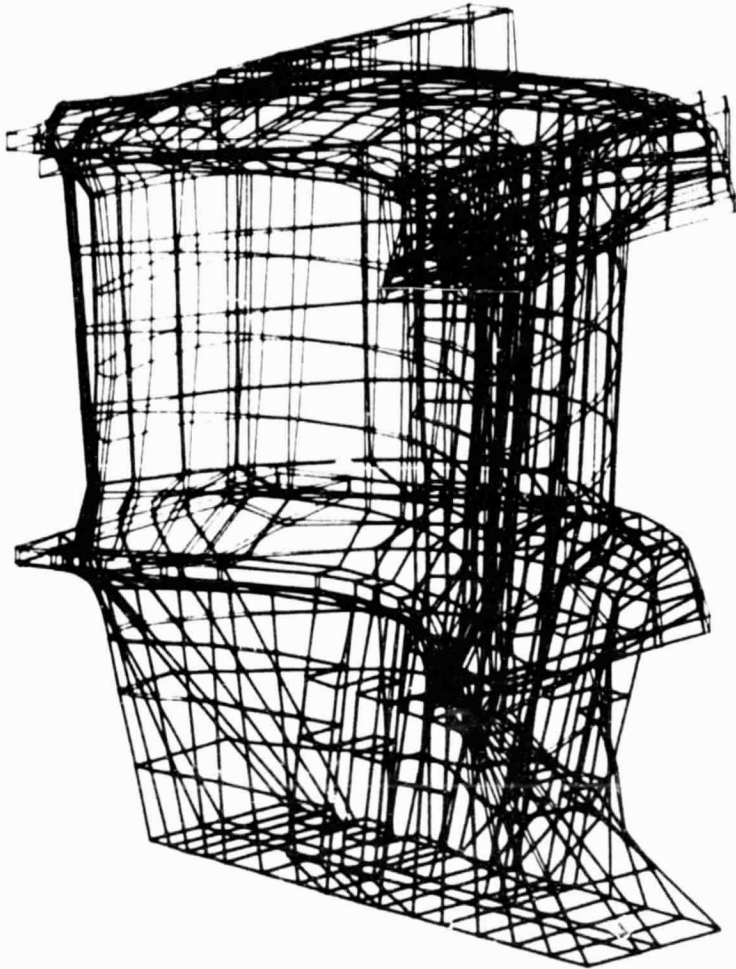

Fig. 2-34 Model 0-1, Mode 8, Freq 51516

ORIGINAL PAGE IS
OF POOR QUALITY

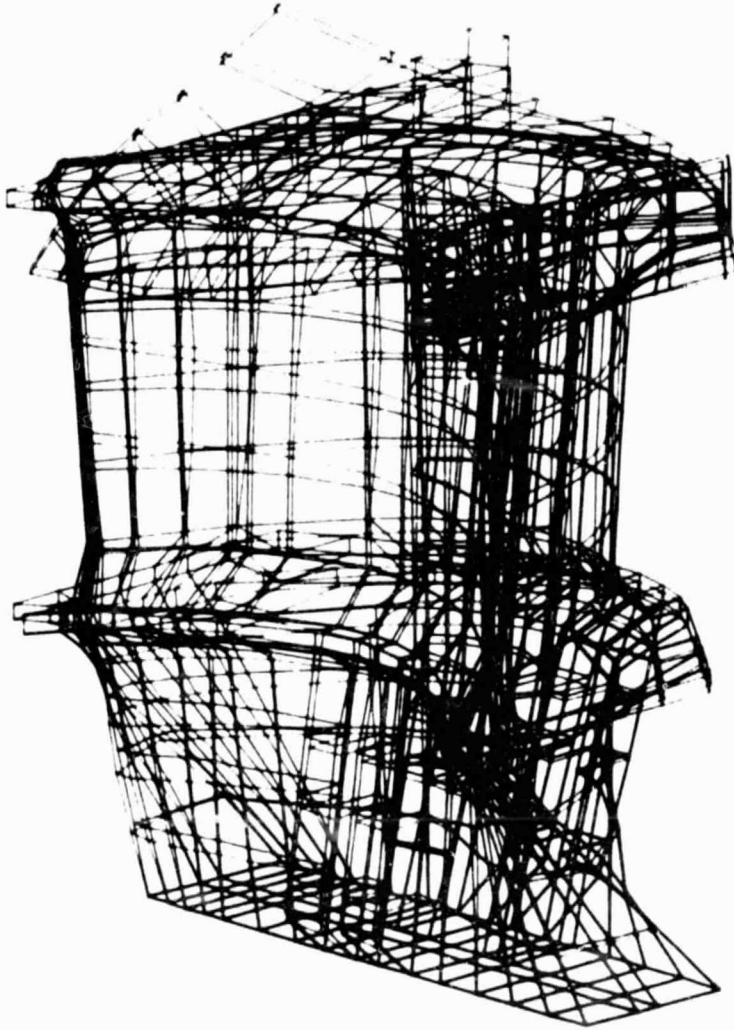

Fig. 2-35 Model 0-1, Mode 9, Freq 60815

ORIGINAL PAGE IS
OF POOR QUALITY

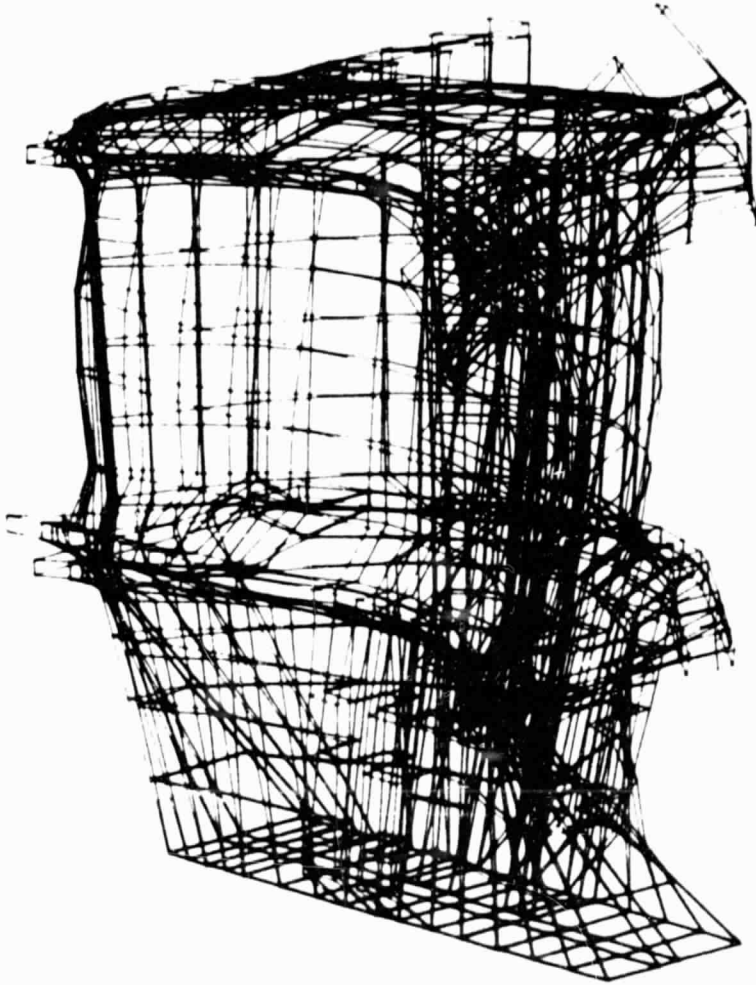

Fig. 2-36 Model 0-1, Mode 10, Freq 62167

ORIGINAL DRAWING
OF POOR QUALITY

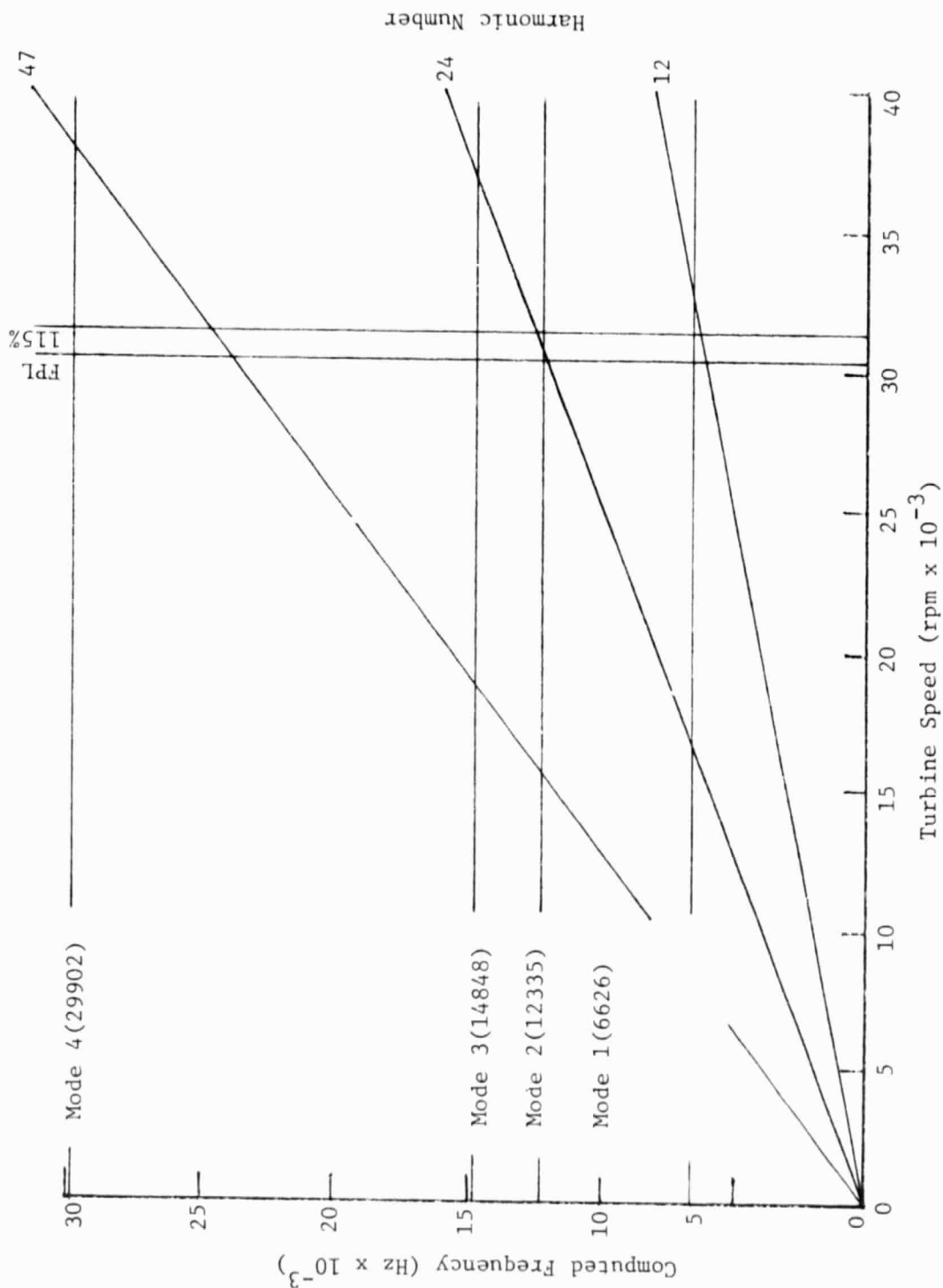

Fig. 2-37 HPOTP First Stage Turbine Blade Campbell Diagram

2.5 HPOTP SECOND STAGE TURBINE BLADE DYNAMICS

The first ten normal modes are summarized in Table 2-4 and Figs. 2-38 through 2-47. The Campbell diagram is shown in Fig. 2-48.

Table 2-4
HPOTP SECOND STAGE TURBINE BLADE NORMAL MODES

<u>Mode</u>	<u>Frequency (Hz)</u>
1	4478
2	9049
3	11124
4	21677
5	26700
6	33982
7	35694
8	41182
9	46274
10	47398

ORIGINAL PAGE IS
OF POOR QUALITY

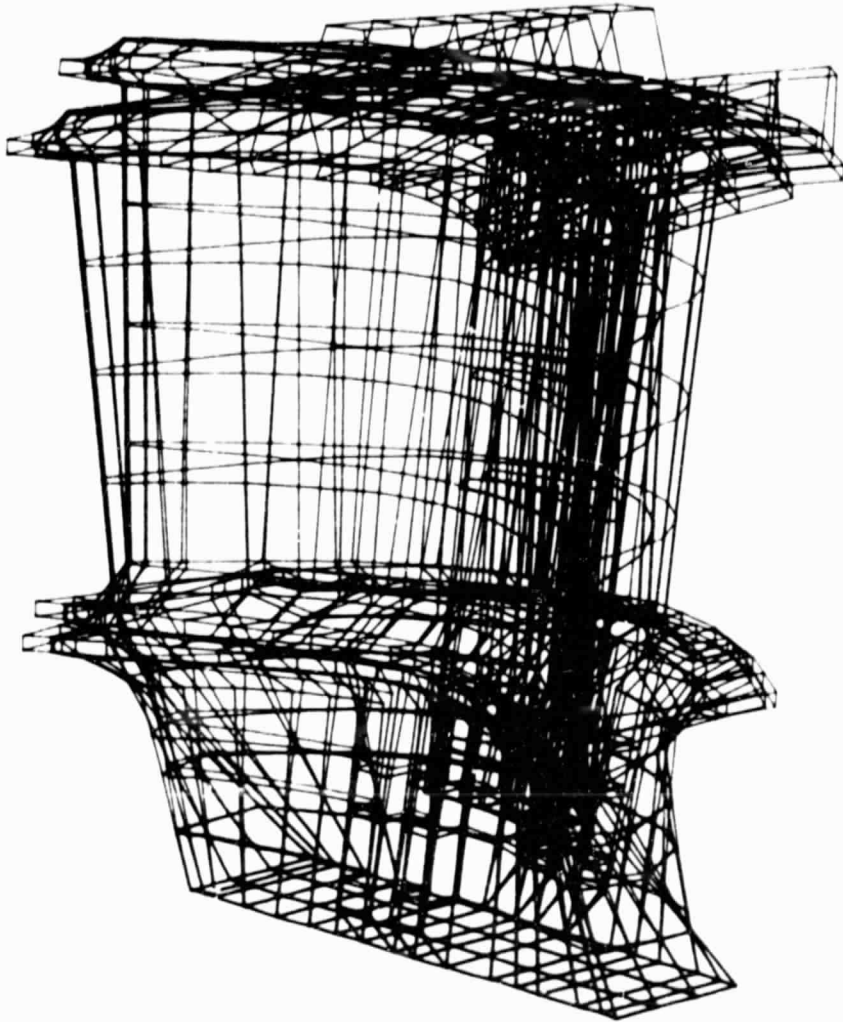

Fig. 2-38 Model O-2, Mode 1, Freq 4478

ORIGINAL PAGE IS
OF POOR QUALITY

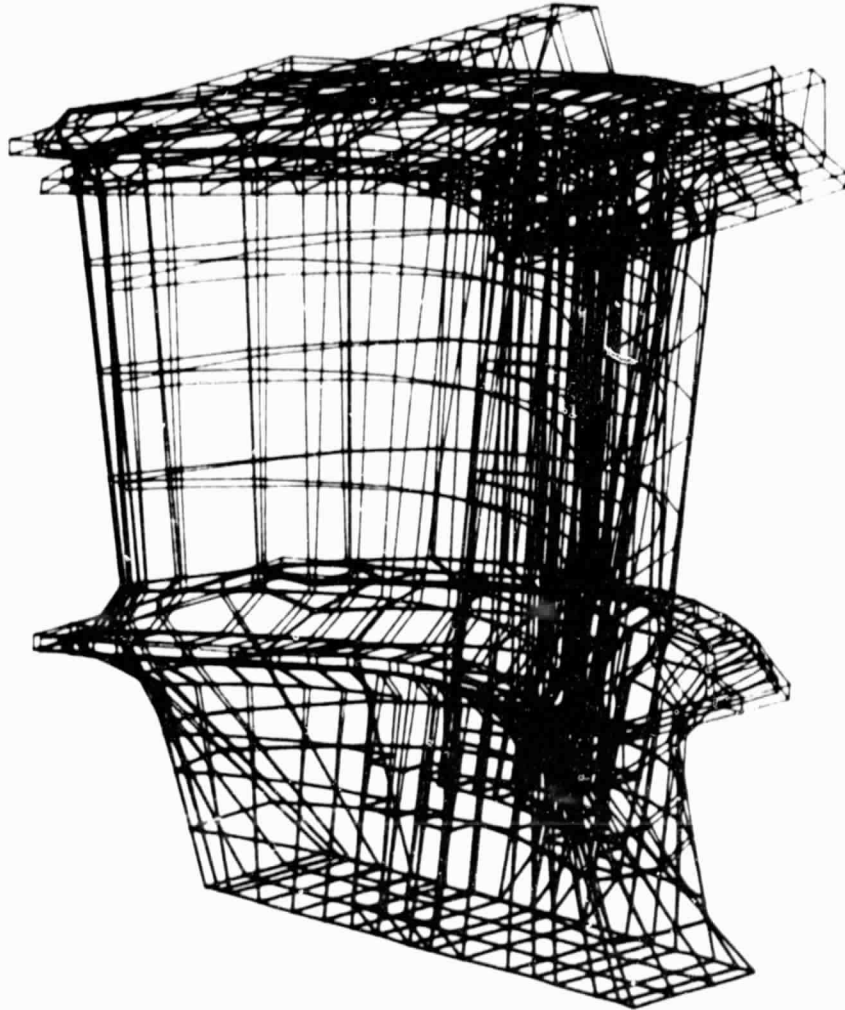

Fig. 2-39 Model O-2, Mode 2, Freq 9049

ORIGINAL PAGE IS
OF POOR QUALITY

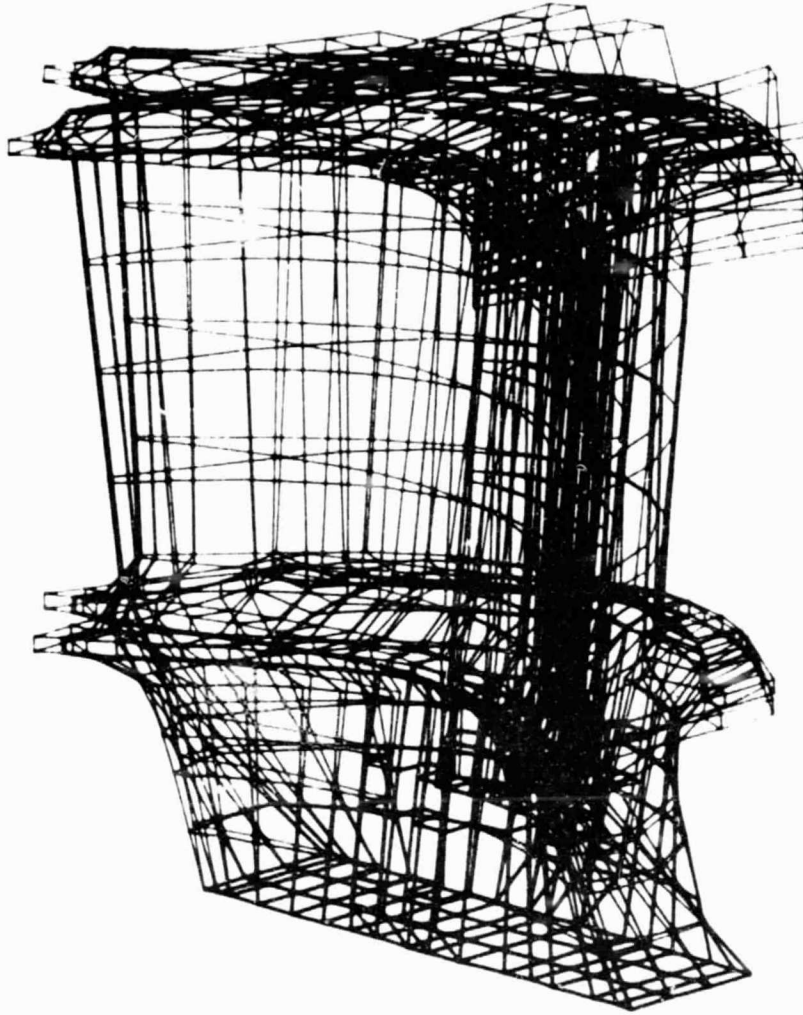

Fig. 2-40 Model O-2, Mode 3, Freq 11124

ORIGINAL PAGE IS
OF POOR QUALITY

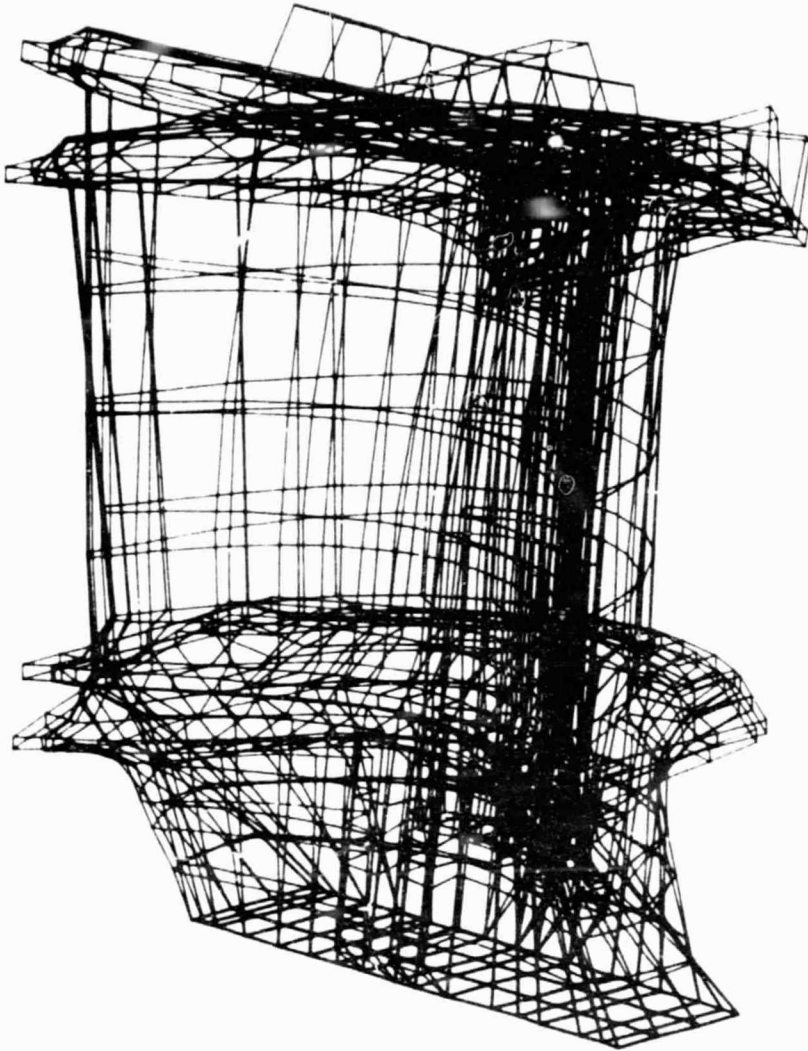

Fig. 2-41 Model 0-2, Mode 4, Freq 21677

ORIGINAL PAGE IS
OF POOR QUALITY

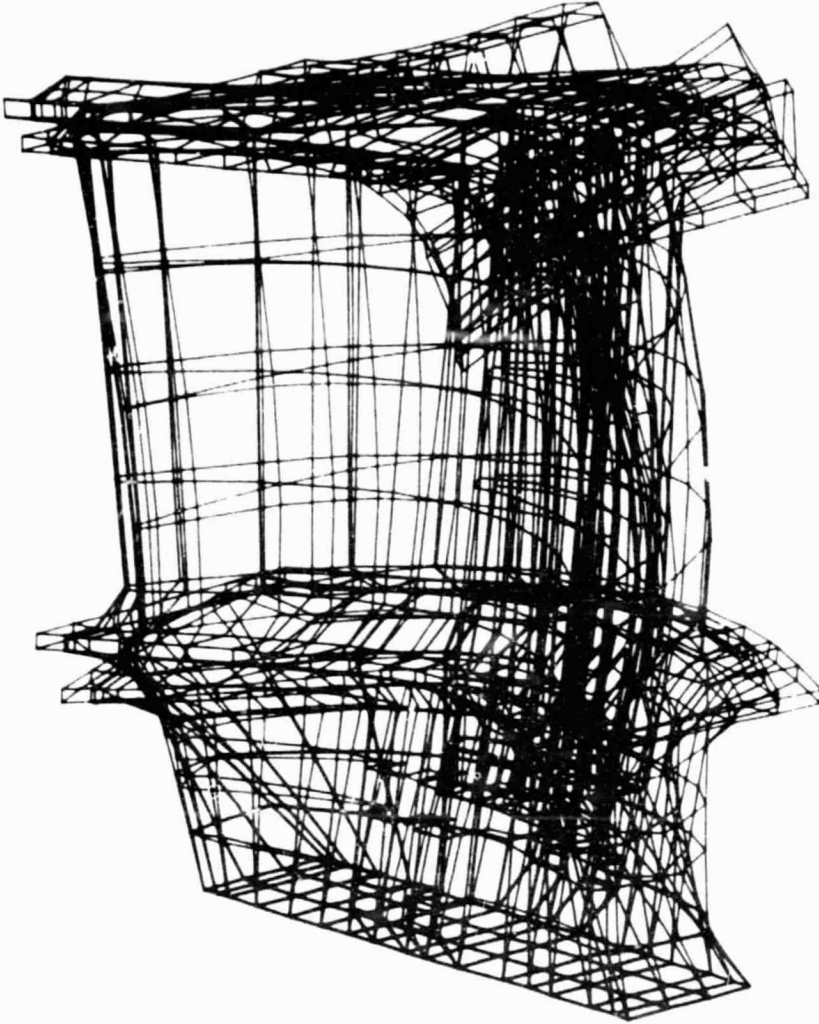

Fig. 2-42 Model 0-2, Mode 5, Freq 26700

ORIGINAL PAGE IS
OF POOR QUALITY.

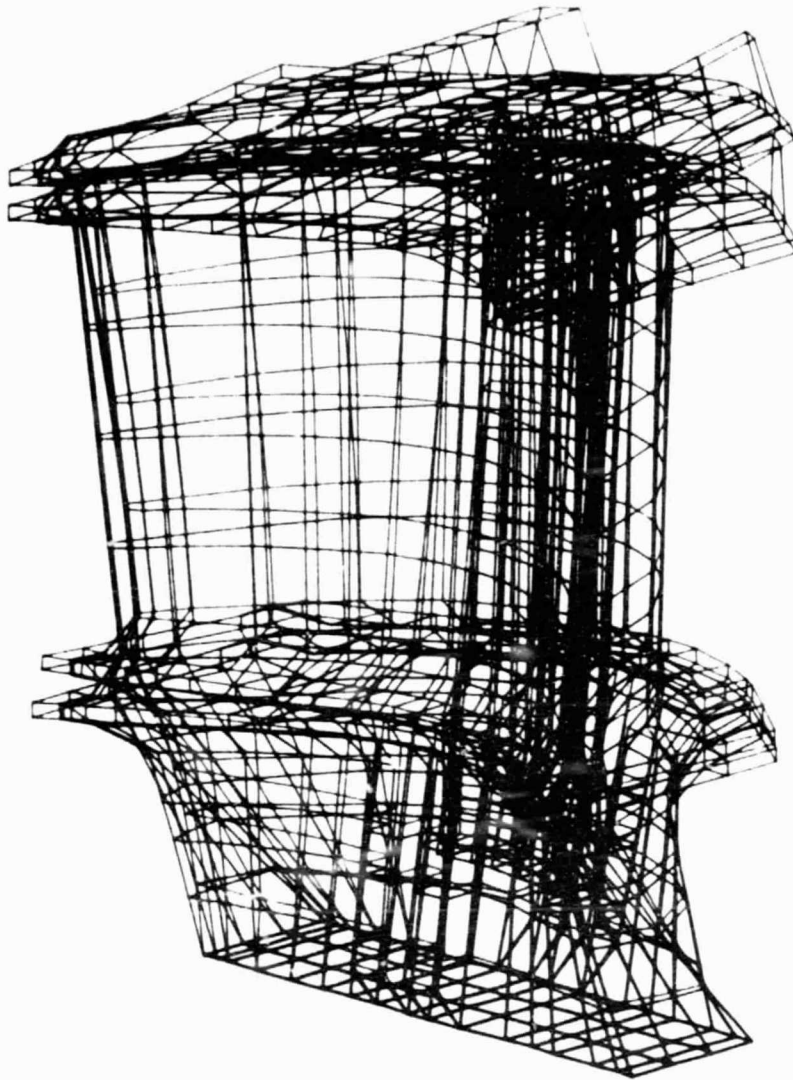

Fig. 2-43 Model 0-2, Mode 6, Freq 33982

ORIGINAL PAGE IS
OF POOR QUALITY

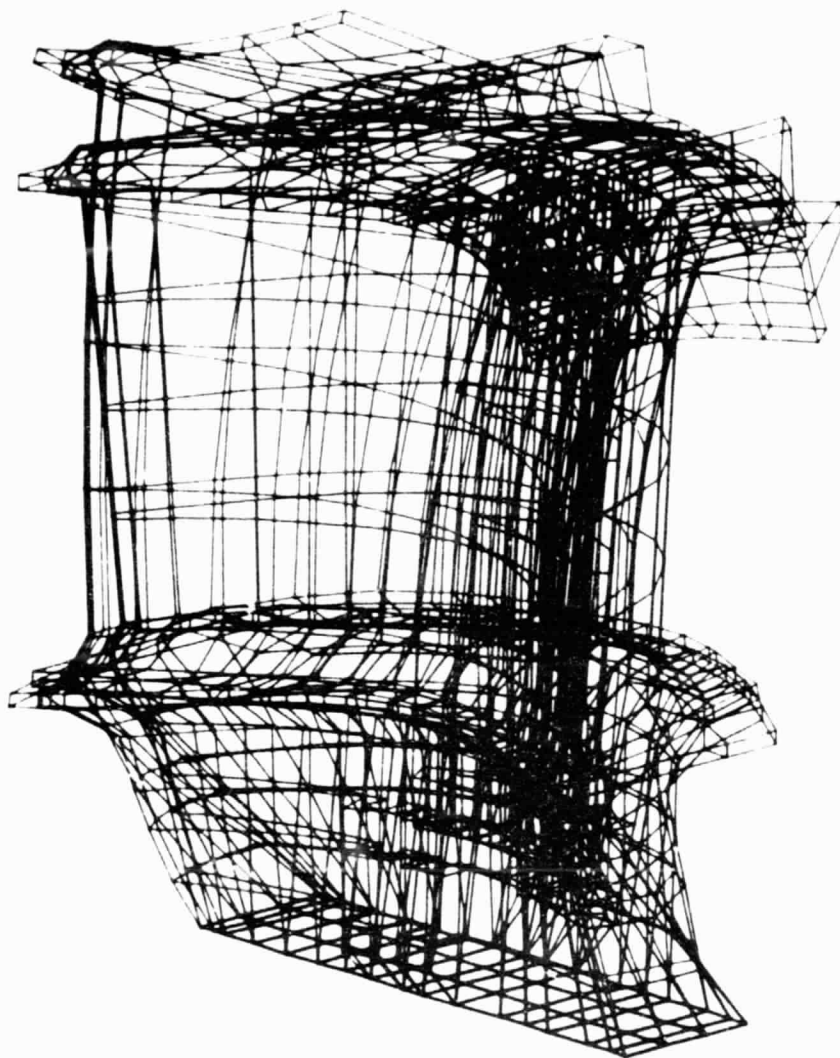

Fig. 2-44 Model O-2, Mode 7, Freq 35694

ORIGINAL PAGE IS
OF POOR QUALITY.

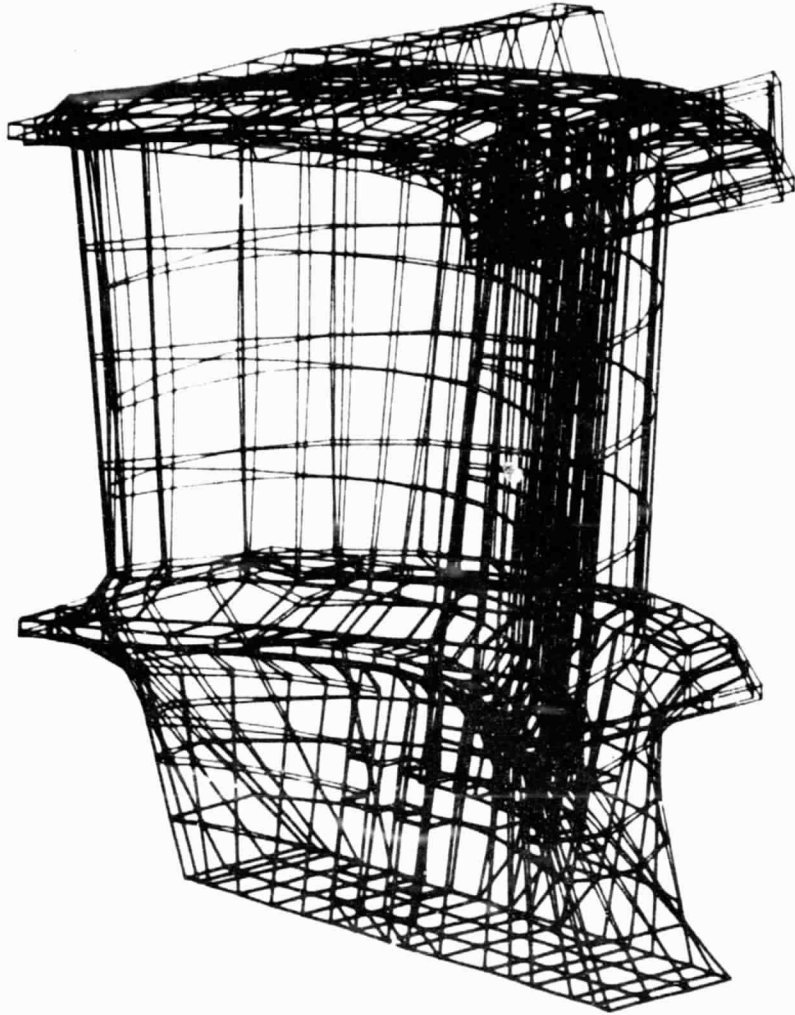

Fig. 2-45 Model 0-2, Mode 8, Freq 41182

ORIGINAL PAGE 19
OF POOR QUALITY

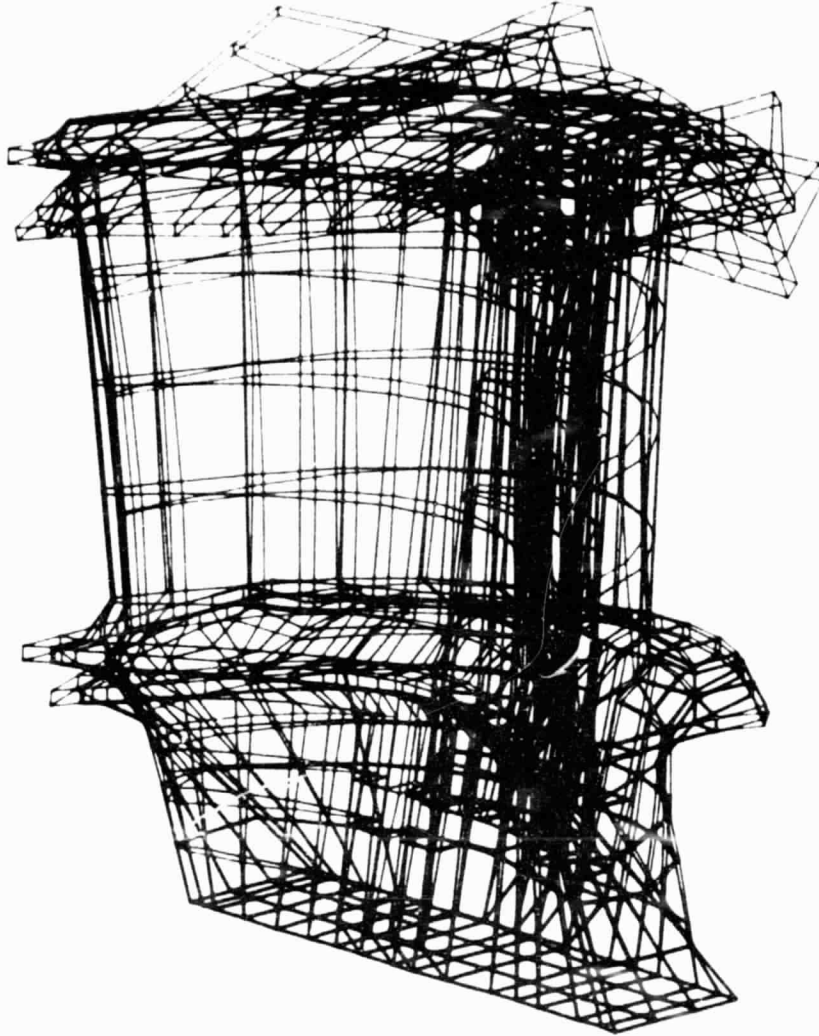

Fig. 2-46 Model 0-2, Mode 9, Freq 46274

ORIGINAL PAGE IS
OF POOR QUALITY

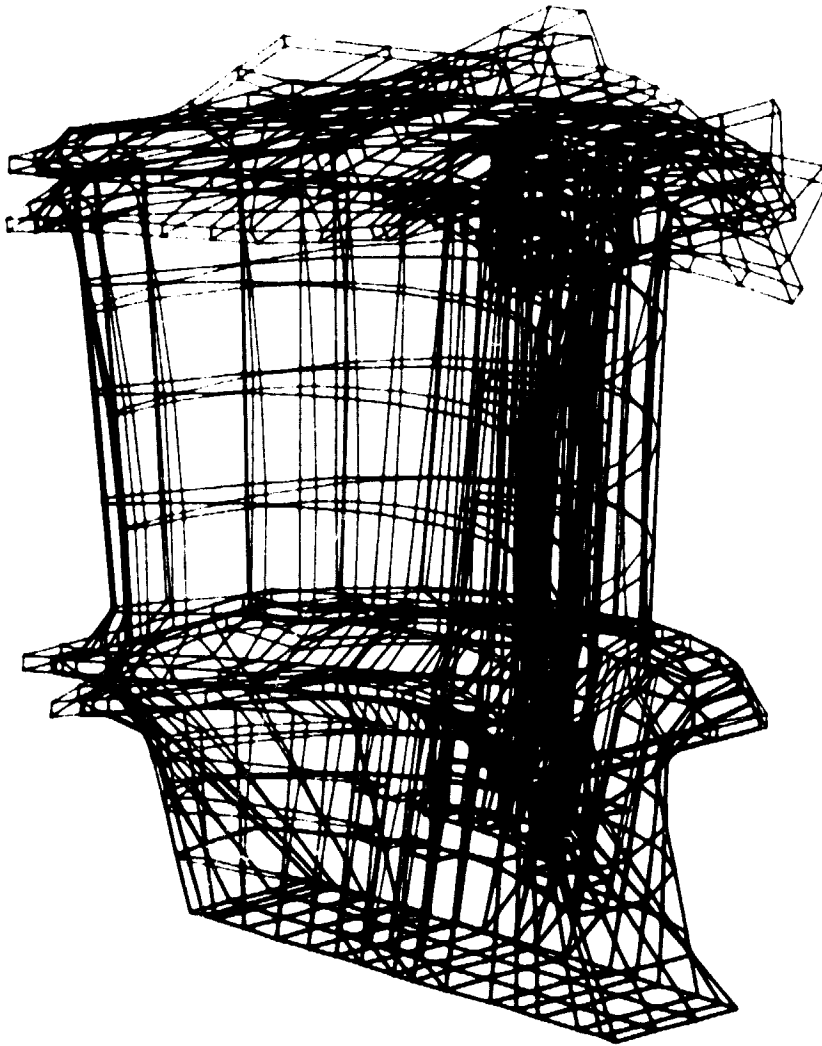

Fig. 2-47 Model 0-2, Mode 10, Freq 47398

ORIGINAL PAGE IS
OF POOR QUALITY

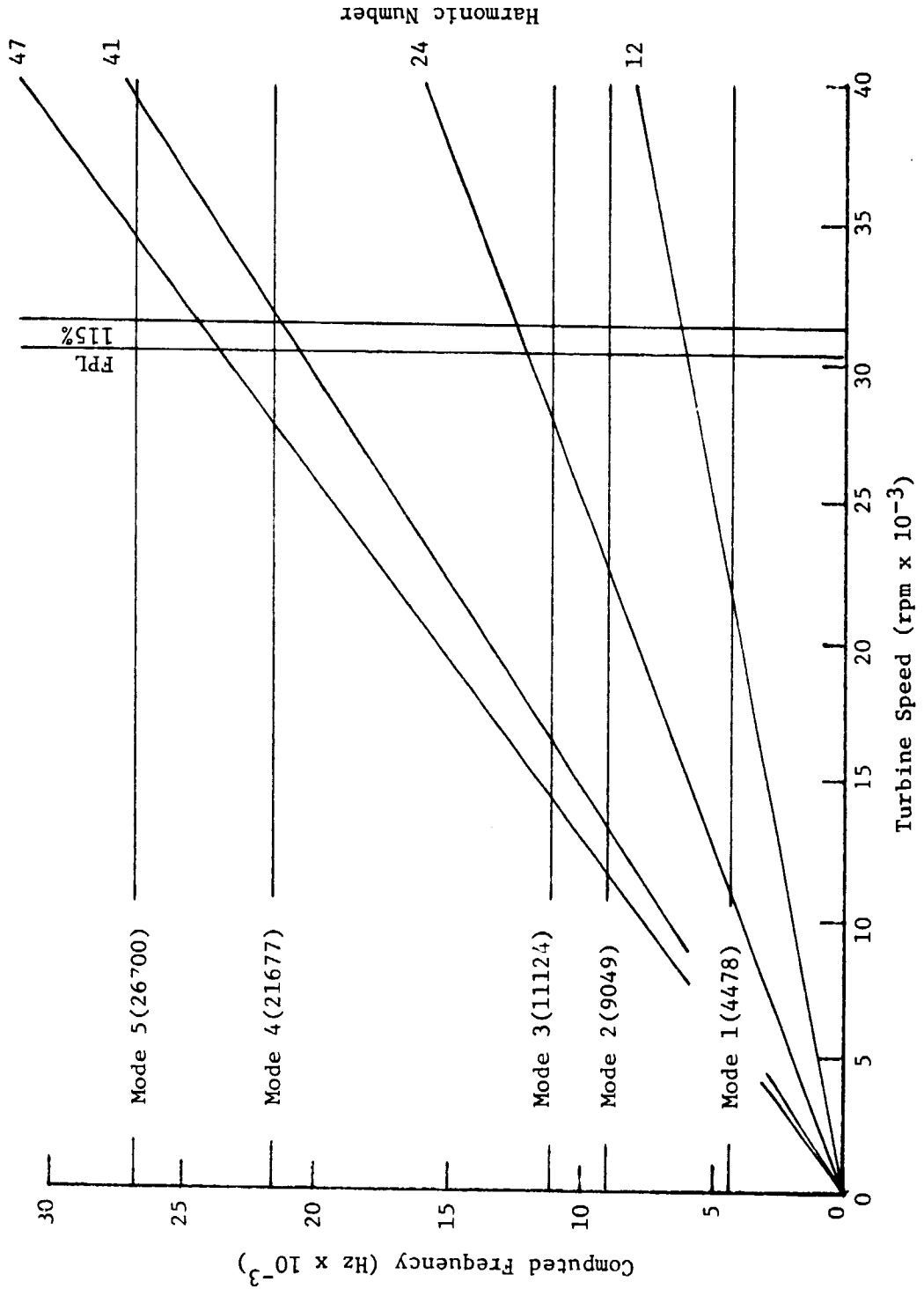

Fig. 2-48 HPOTP Second Stage Turbine Blade Campbell Diagram

3. SSME NOZZLE DYNAMICS

The lower modes of the nozzles are summarized in Table 3-1 and Figs. 3-14 through 3-56. For brevity, the components are identified in tables and figures as follows:

- F1 - First Stage Fuel Nozzle
- F2 - Second Stage Fuel Nozzle
- O1 - First Stage Oxygen Nozzle
- O2 - Second Stage Oxygen Nozzle

No Campbell diagrams are presented due to lack of definition of potential driver. We recognize that further work on these nozzles is desirable to lead to a good knowledge of their dynamics, and recommend that it be performed in the future. This analysis does, however, provide a basis for that projected work and points the direction it should follow.

3.1 SSME NOZZLES - MODEL DESCRIPTION AND SUMMARY OF RESULTS

Four NASTRAN nozzle models were made to simulate airfoil blade segments of the first and second stage HPFTP (F1 and F2 models) and first and second stage HPOTP (O1 and O2 models). The general approach to all four models is the same. Figure 3-1 shows a typical complete nozzle casting.

The grids are defined in rectangular coordinate systems with the Z axis radially outward and with the X axis in the direction of gas flow. The exception is model F2 which has the Y axis in the direction of gas flow. The displacement coordinate system is cylindrical. Fig. 3-2 presents the typical coordinate system arrangement. Figure 3-3 gives the model F2 coordinate system.

Boundary conditions applied to the modeled segments are as follows: constraints on rigid body movement of the whole assembly are placed on the casting support points as shown in Fig. 3-4. Constraints are also made on each point of one cut surface such that it translates equally with its corresponding point on the opposite cut surface. This ensures that the segment acts symmetrically with its implied adjacent segments (Fig. 3-5).

The four models use primarily CIHEX1 elements with CWEDGE and CTETRA elements as required. Grid and element ID number prefixes increase with increasing radius in levels as shown in Figs. 3-5, 3-8, 3-10 and 3-12. Plots showing elements and grids at representative levels follow each figure given.

After the models were executed for normal modes, a processor was run to generate very thin (1×10^{-6} in.) CQUAD1 elements over all exposed surfaces. The grids defining these elements were used to interpolate thermal and pressure data from load source models. The CQUAD1 elements are also used for stress contour plots at each major surface.

Table 3-1
NOZZLE MODEL NORMAL MODES SUMMARY

Mode	Model F1 (Hz)	Model F2 (Hz)	Model O1 (Hz)	Model O2 (Hz)
1	3466	2726	3262	3634
2	5599	3371	5445	5006
3	11978	6104	10777	6204
4	13948	14698	11049	7562
5	19017	15955	14505	9176
6	20148	18375	21274	10146
7	26149	21334	23895	11748
8	28266	26211	28514	15554
9	29037	27225	34686	20837
10	-	30403	35871	24911
11	-	-	39171	25737
12	-	-	41348	26562
13	-	-	42090	30007

ORIGINAL DRAWING
OF POOR QUALITY

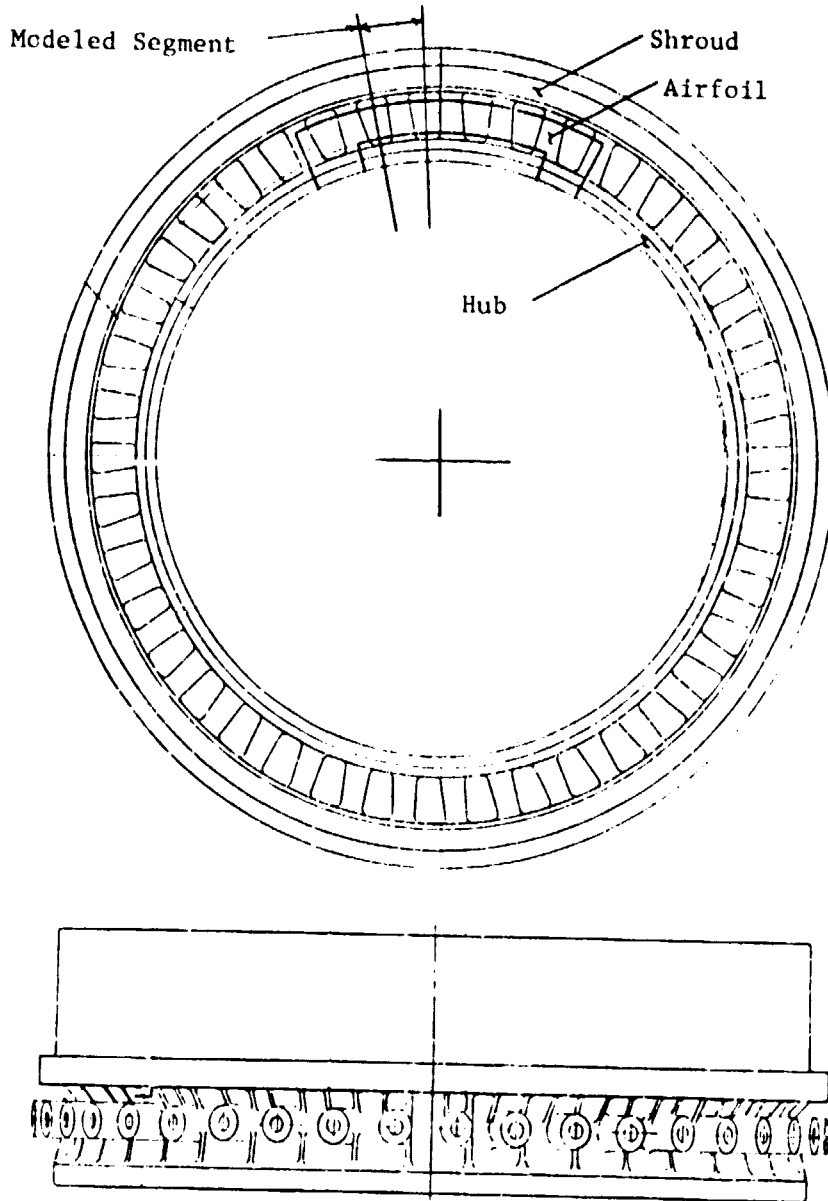

Fig. 3-1 Typical Nozzle Casting Showing Modeled Segment

ORIGINAL PAGE IS
OF POOR QUALITY

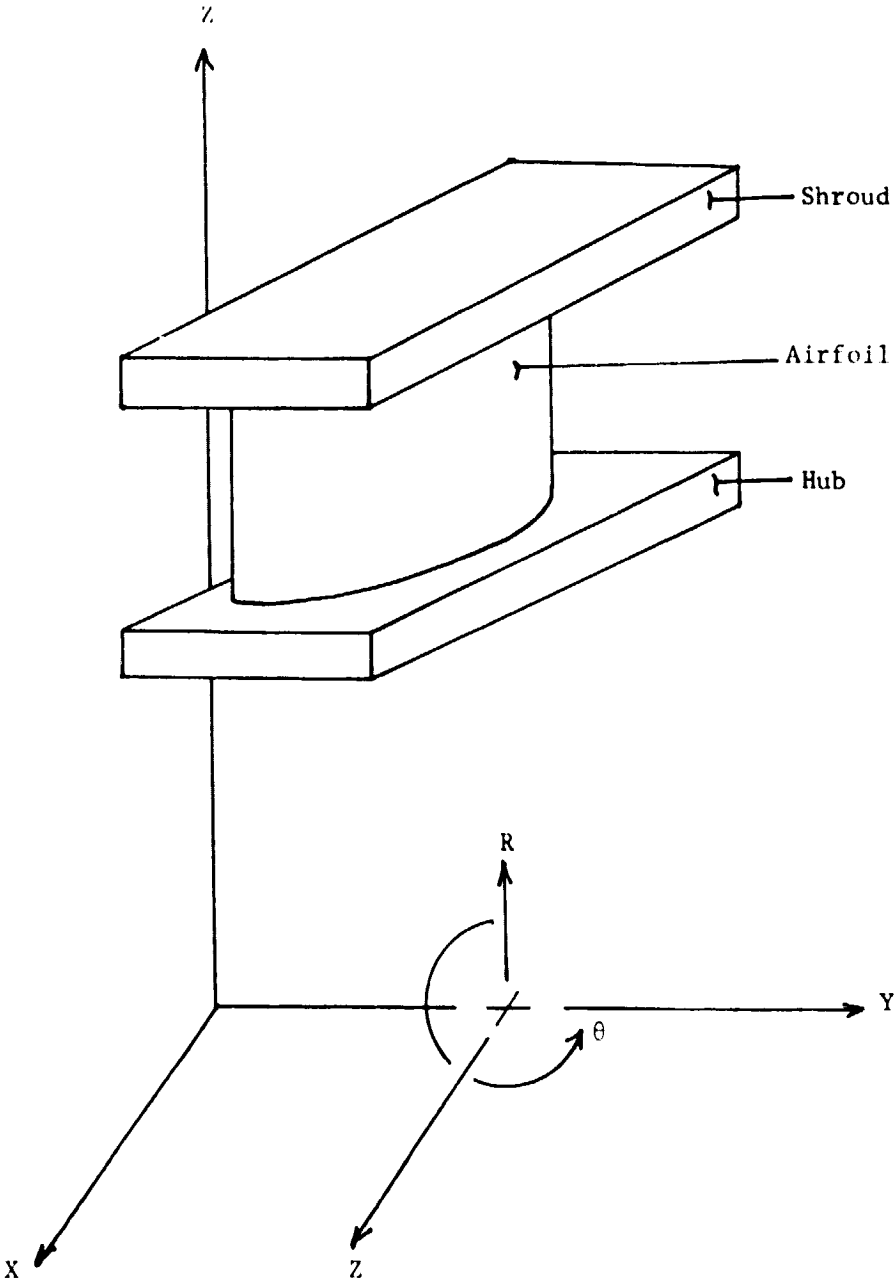

Fig. 3-2 Coordinate Systems for Models F1, O1, and O2

ORIGINAL COPY OF
OF POOR QUALITY

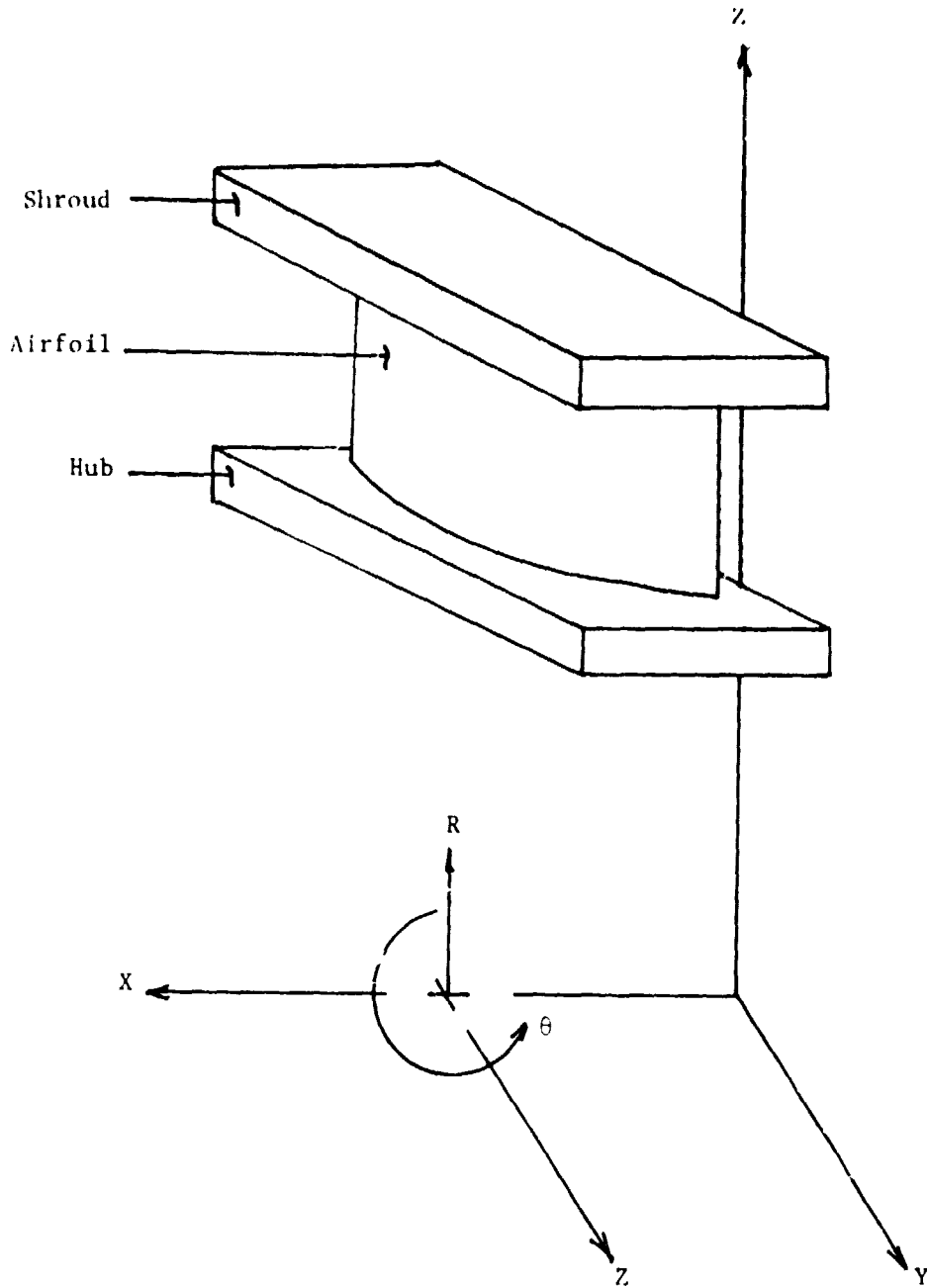

Fig. 3-3 Coordinate System for Model F2

ORIGINAL DRAWING
OF POOR QUALITY

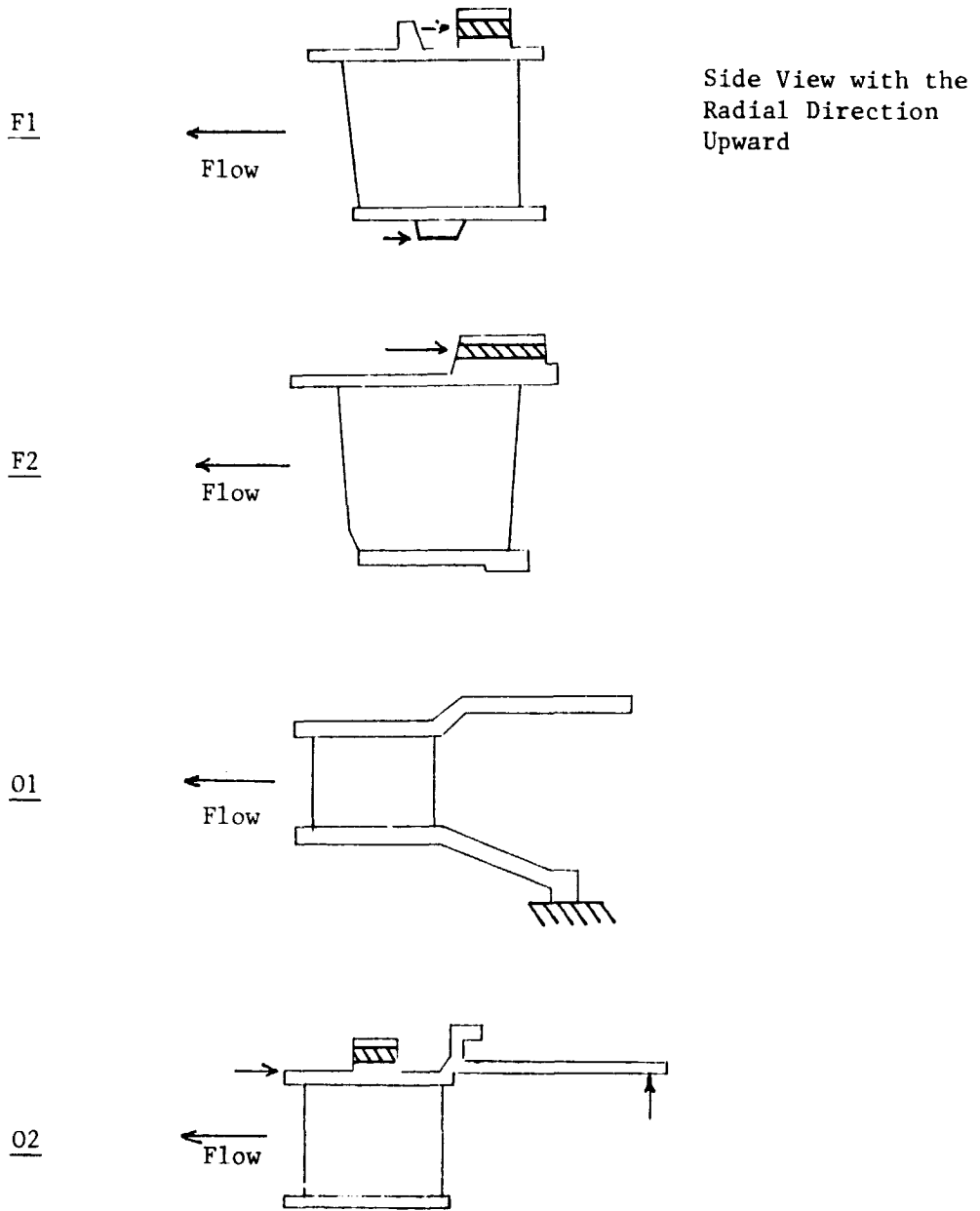
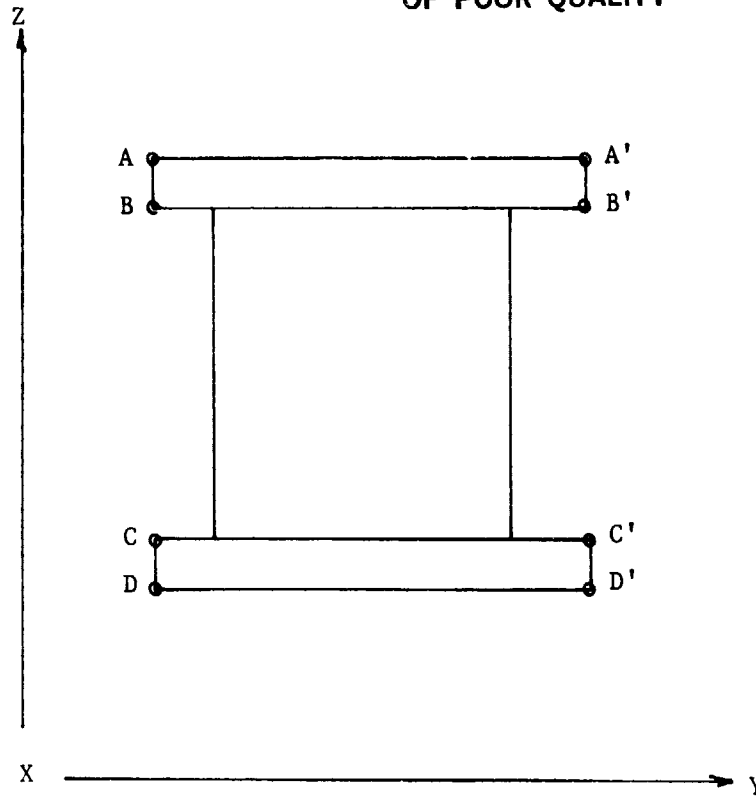

Fig. 3-4 Rigid Body Support Points

ORIGINAL PAGE IS
OF POOR QUALITY



$$\begin{array}{ll}
 C_{AX} = C_{A'X} & C_{BX} = C_{B'} \\
 C_{AY} = C_{A'Y} & C_{BY} = C_{B'} \\
 C_{AZ} = C_{A'Z} & C_{BZ} = C_{B''} \\
 \\
 C_{CX} = C_{C'X} & C_{DX} = C_{D'} \\
 C_{CY} = C_{C'Y} & C_{DY} = C_{D'} \\
 C_{CZ} = C_{C'Z} & C_{DZ} = C_{D'}
 \end{array}$$

Fig. 3-5 Coupled Constraints Between Cut Surfaces

ORIGINAL PAGE IS
OF POOR QUALITY

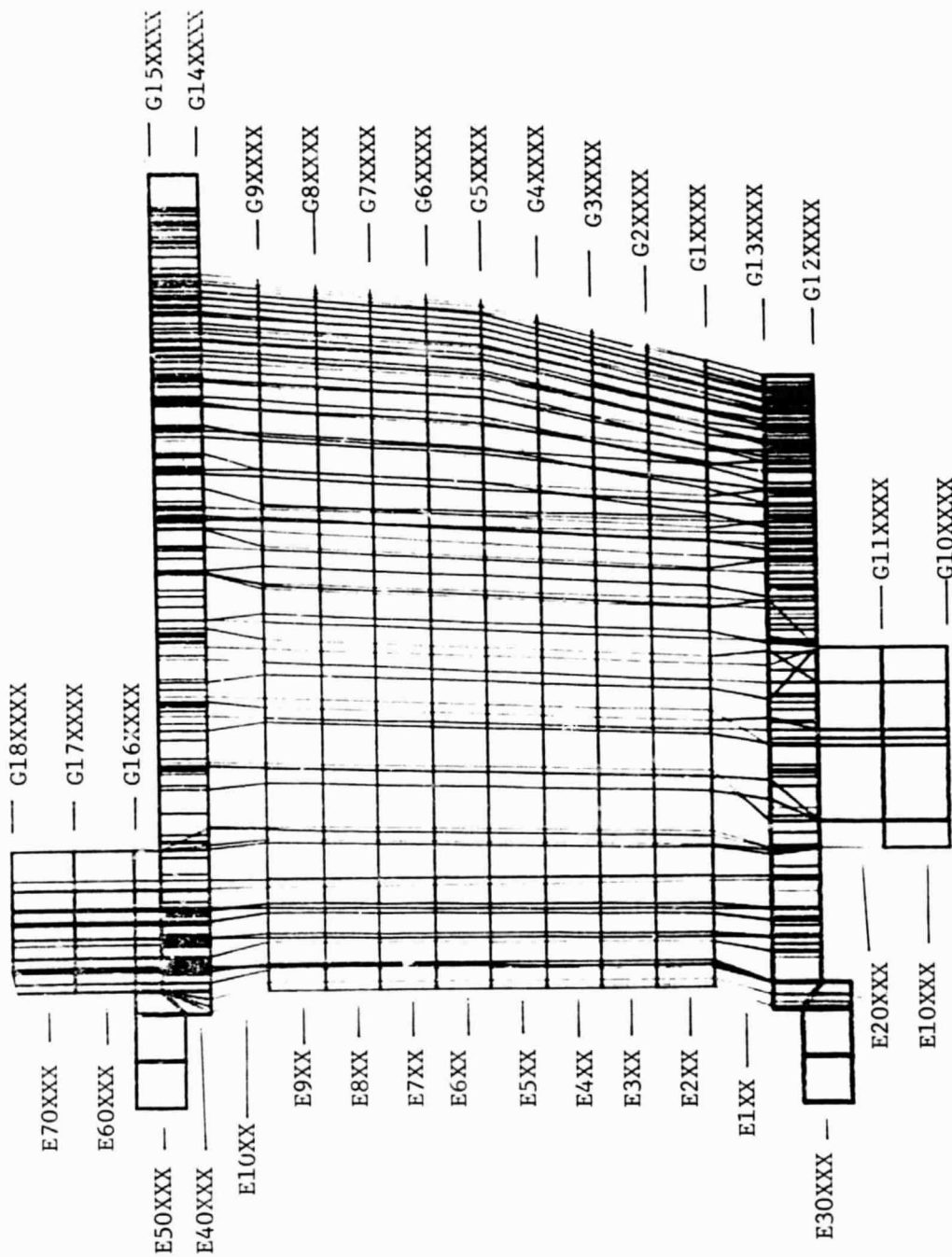

Fig. 3-6 F1 Model Element and Grid Prefixes

ORIGINAL PAGE IS
OF POOR QUALITY

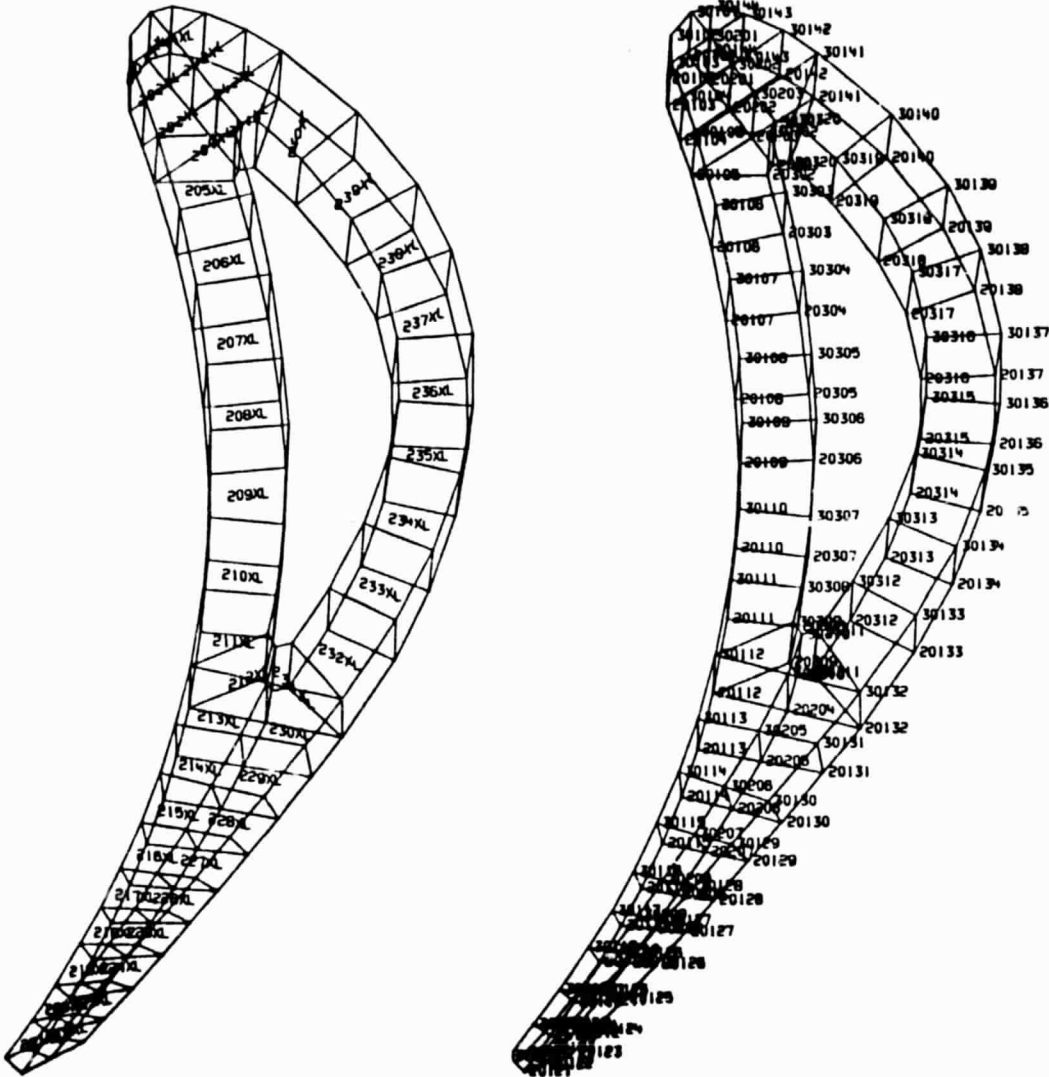

Fig. 3-7 F1 Model Representative Airfoil Section

ORIGINAL PAGE IS
OF POOR QUALITY

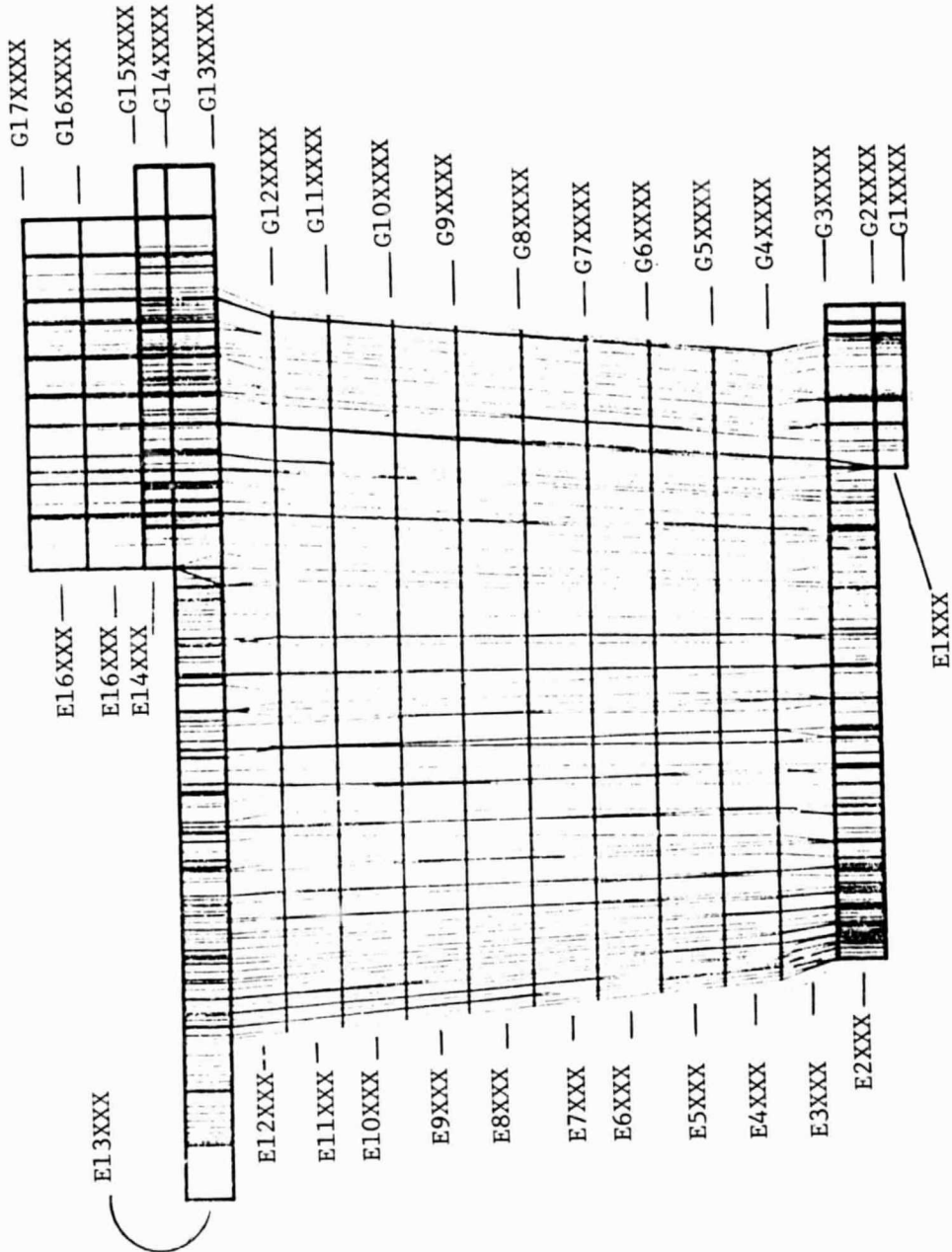

Fig. 3-8 F2 Model Element and Grid ID Prefixes

ORIGINAL PAGE IS
OF POOR QUALITY

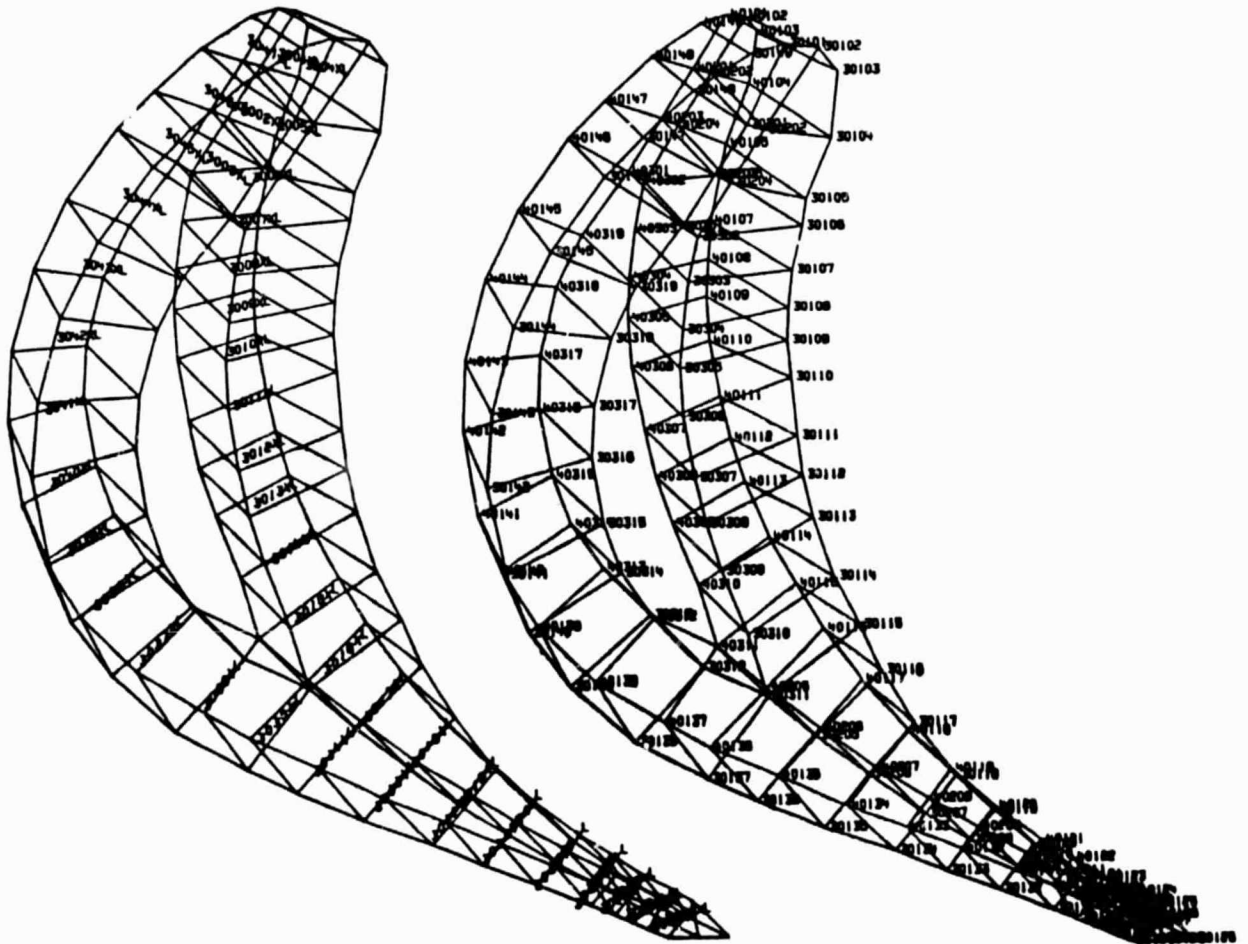

Fig. 3-9 F-2 Model Representative Airfoil Section

ORIGINAL PAGE IS
OF POOR QUALITY

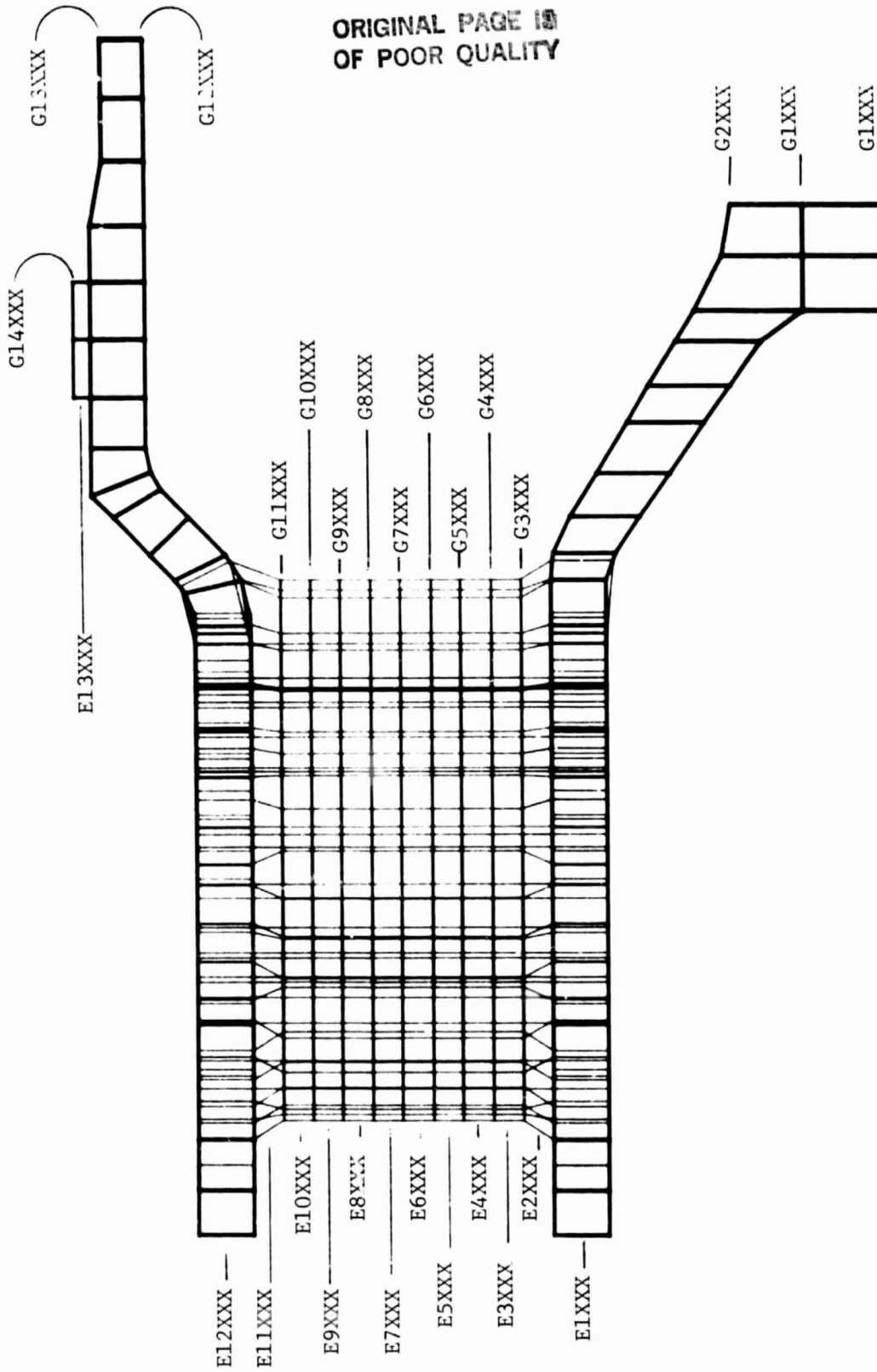

Fig. 3-10 01 Model Element and Grid Prefixes

ORIGINAL PAGE IS
OF POOR QUALITY

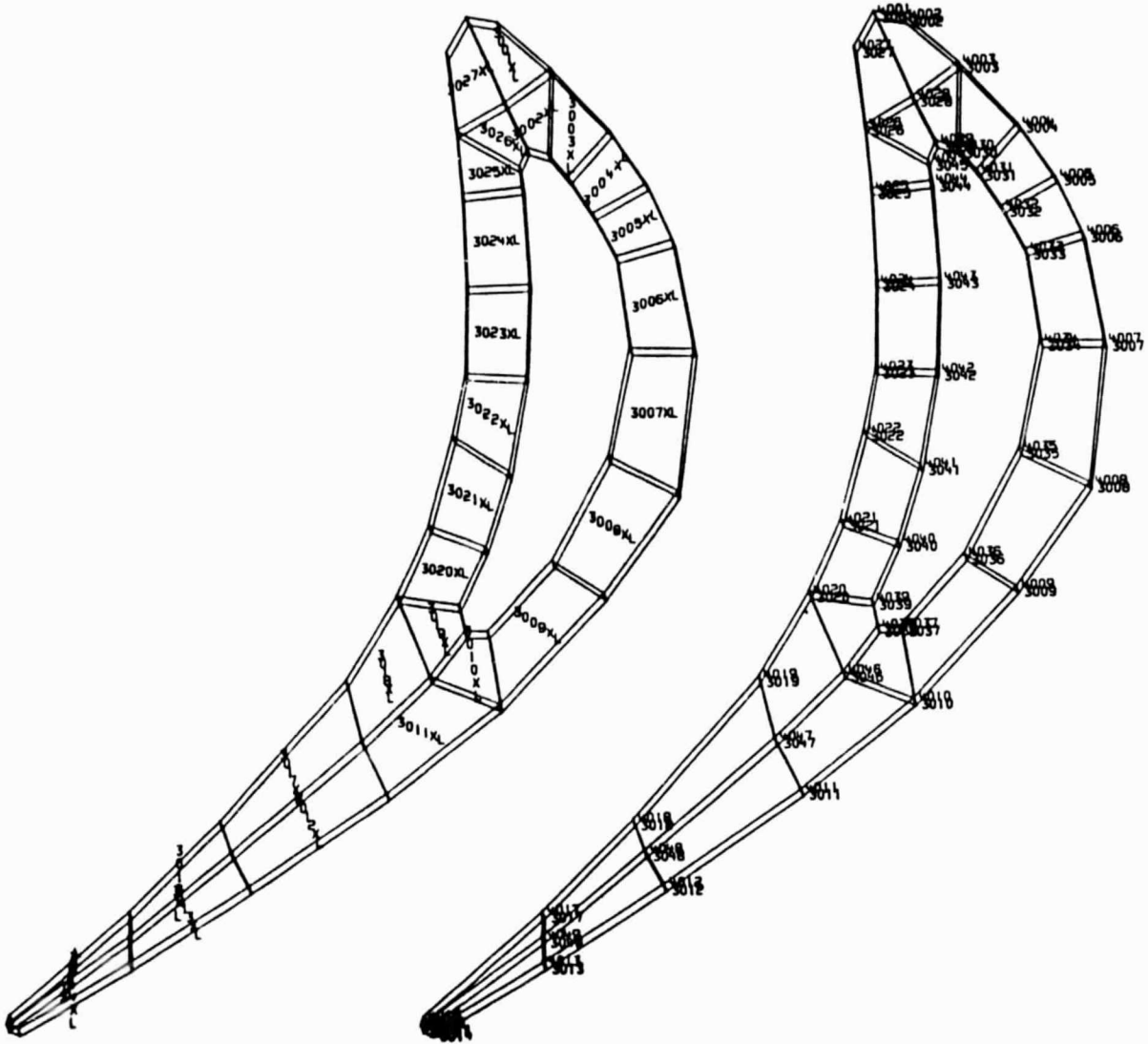

Fig. 3-11 O1 Model Representative Section

ORIGINAL PAGE IS
OF POOR QUALITY

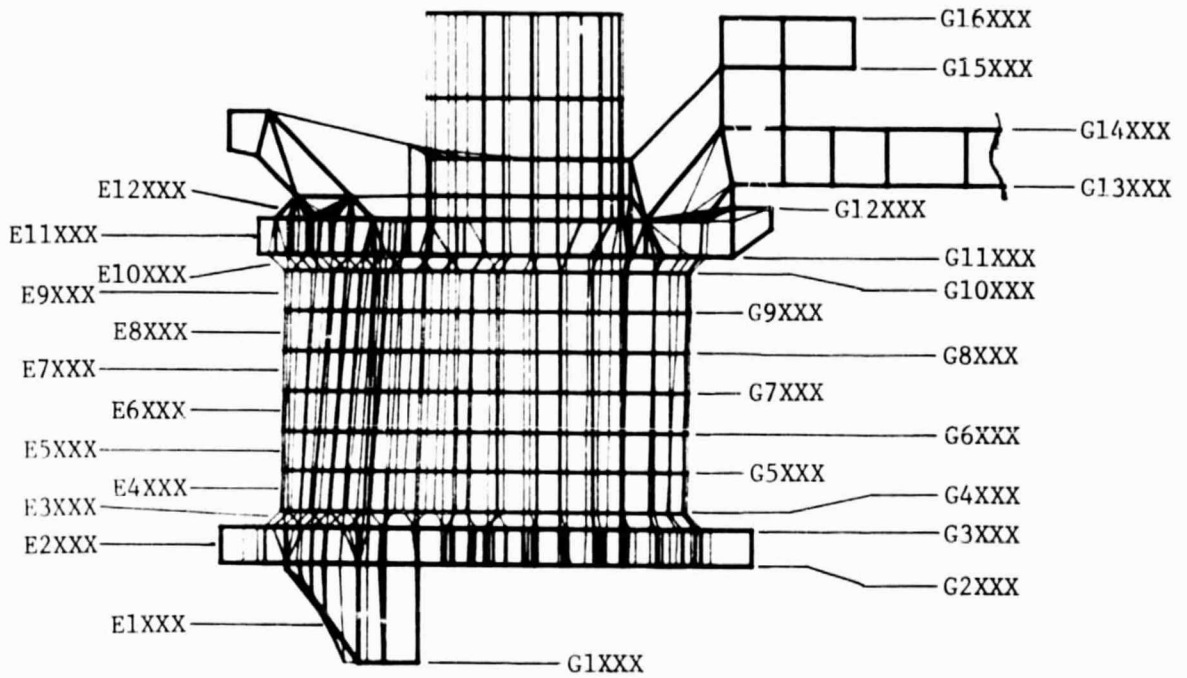

Fig. 3-12 02 Model Element and Grid Prefixes

ORIGINAL PAGE IS
OF POOR QUALITY

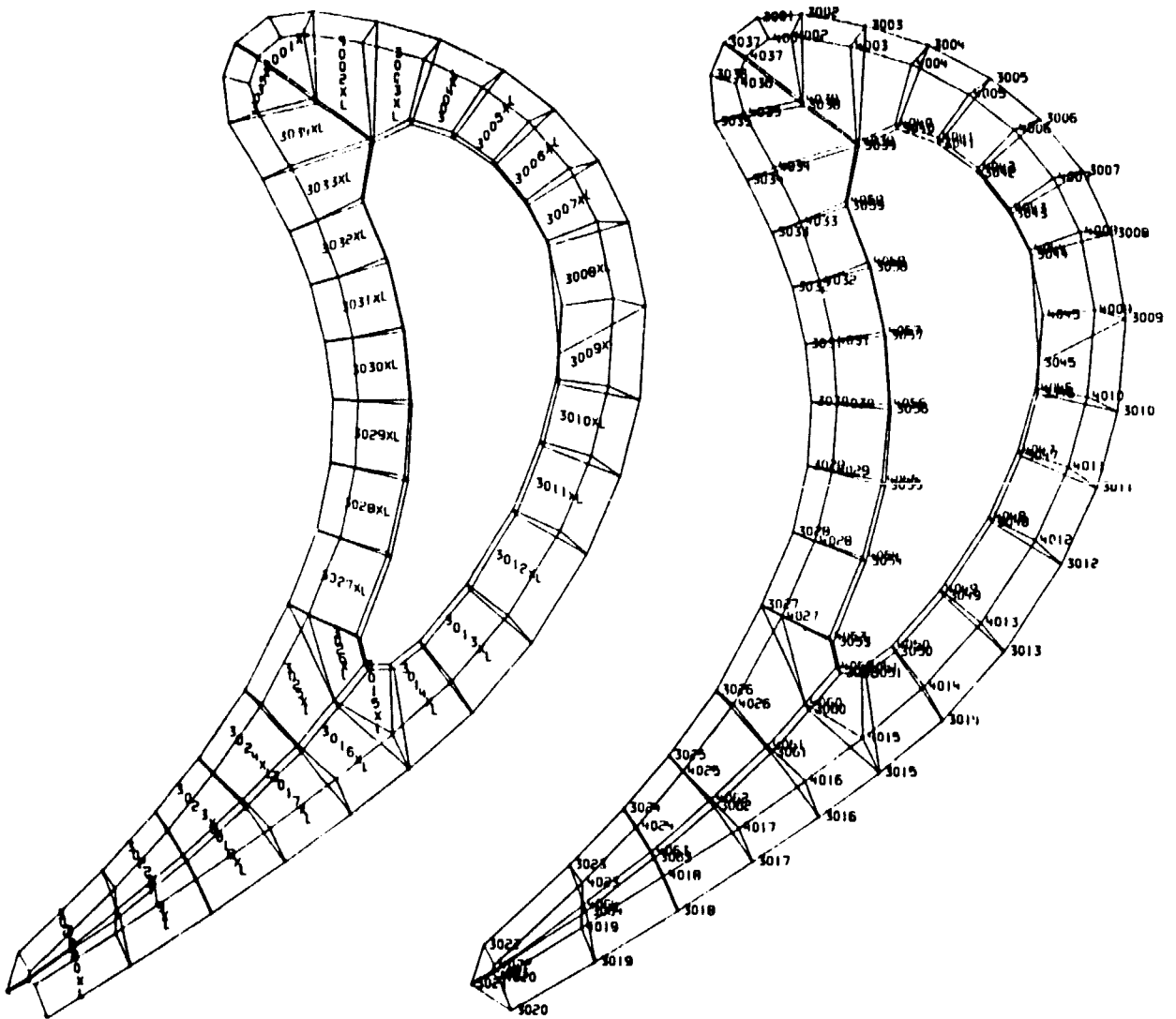

Fig. 3-13 02 Model Representative Section

ORIGINAL PAGE IS
OF POOR QUALITY

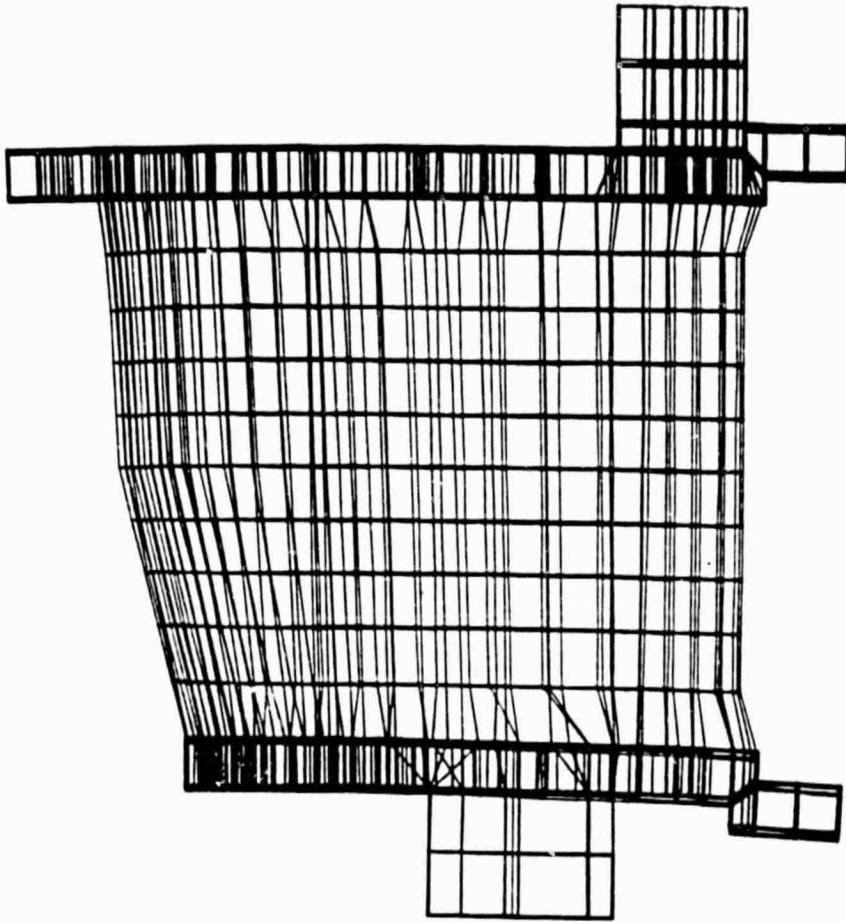

Fig. 3-14 Model F1, Mode 1, Freq 3467

ORIGINAL PAGE IS
OF POOR QUALITY

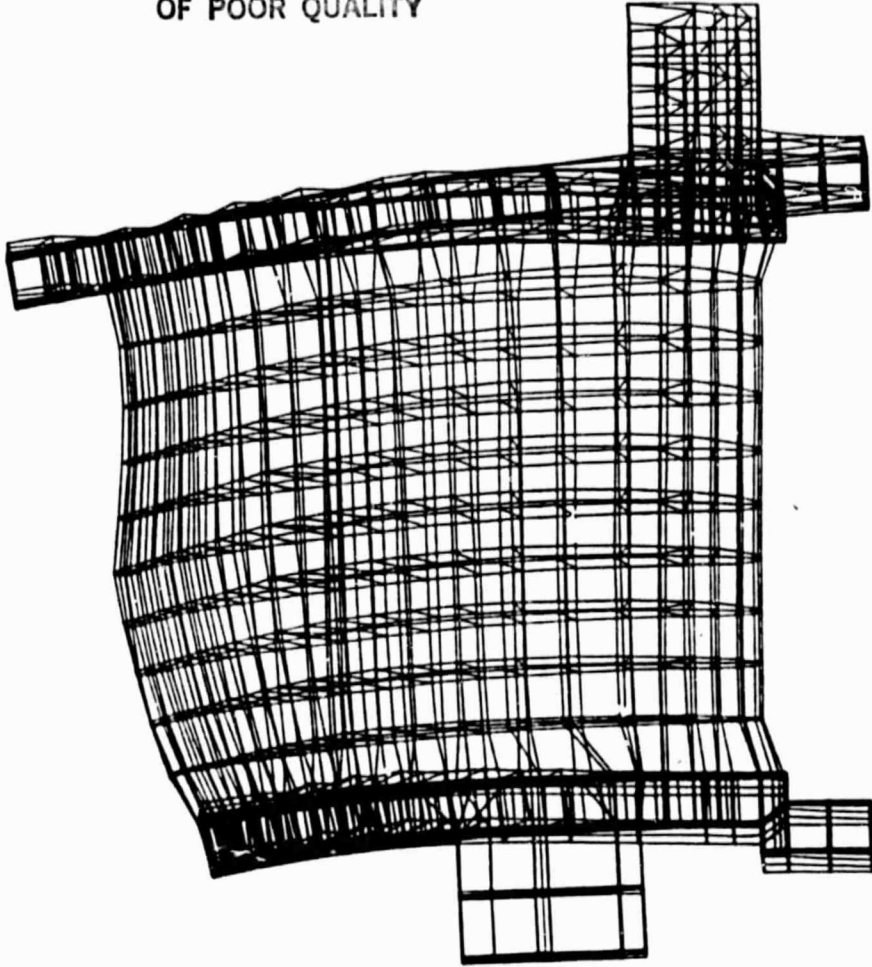

Fig. 3-15 Model F1, Mode 2, Freq 5599

ORIGINAL PAGE IS
OF POOR QUALITY

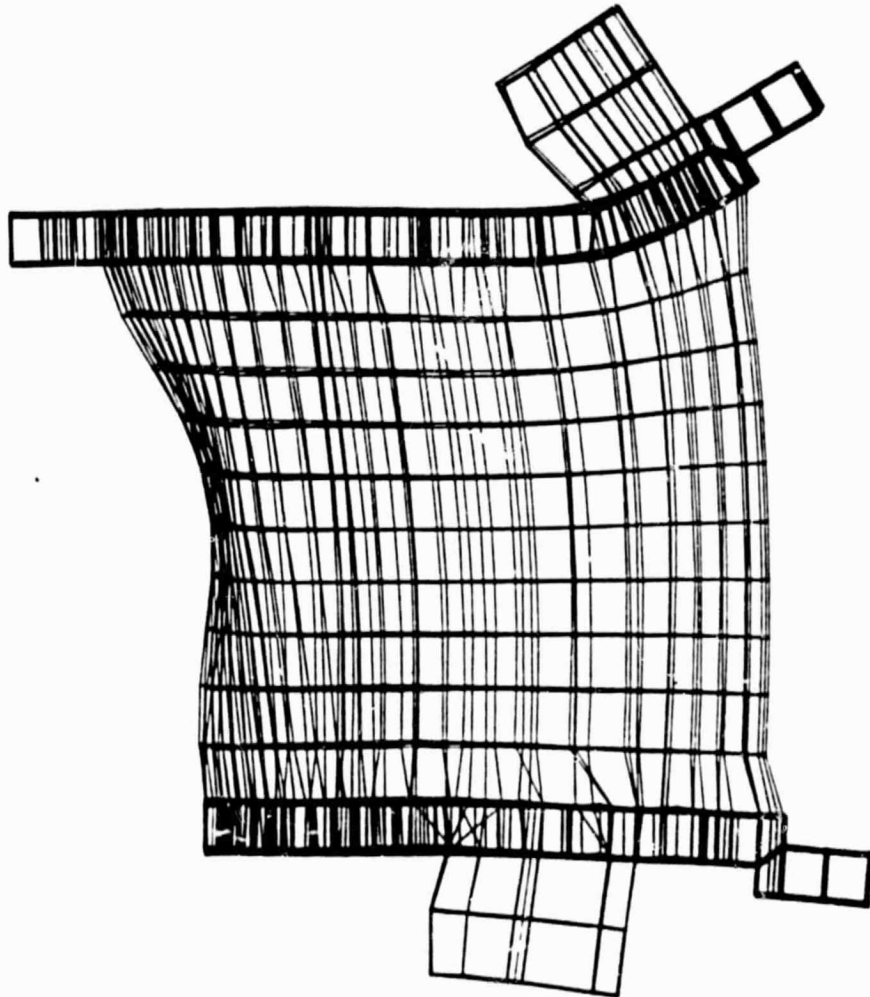

Fig. 3-16 Model F1, Mode 3, Freq 11987

ORIGINAL PAGE IS
OF POOR QUALITY

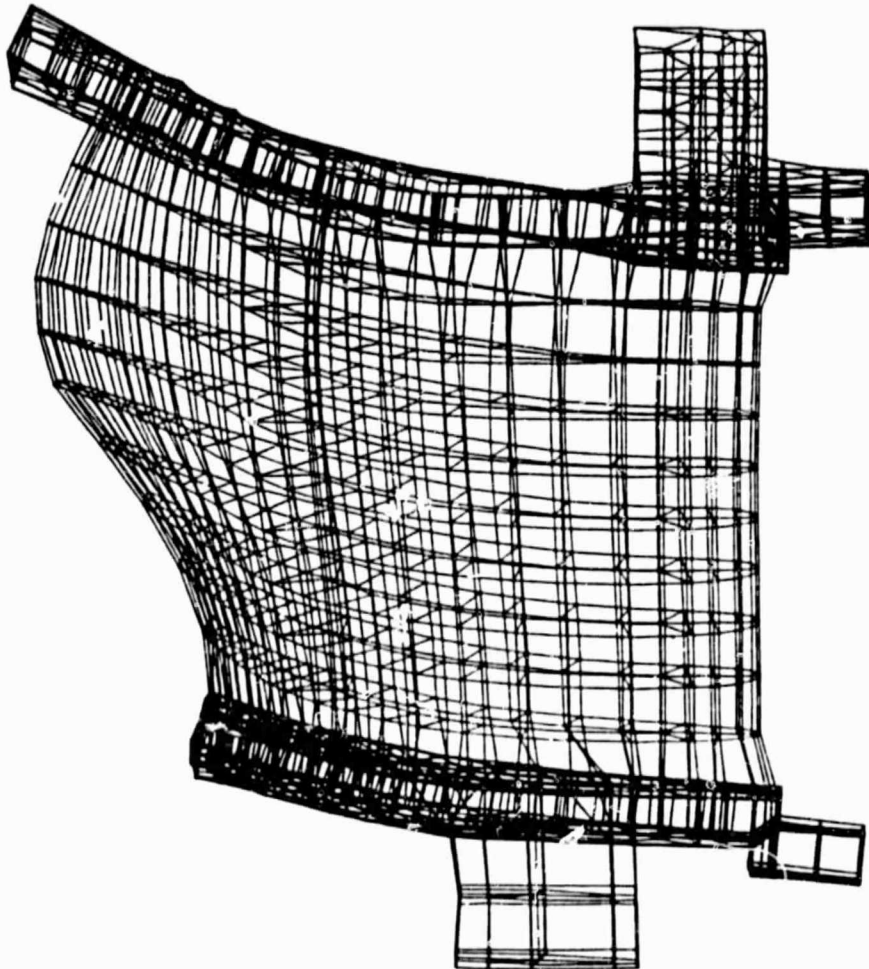

Fig. 3-17 Model F1, Mode 4, Freq 13948

ORIGINAL PAGE IS
OF POOR QUALITY

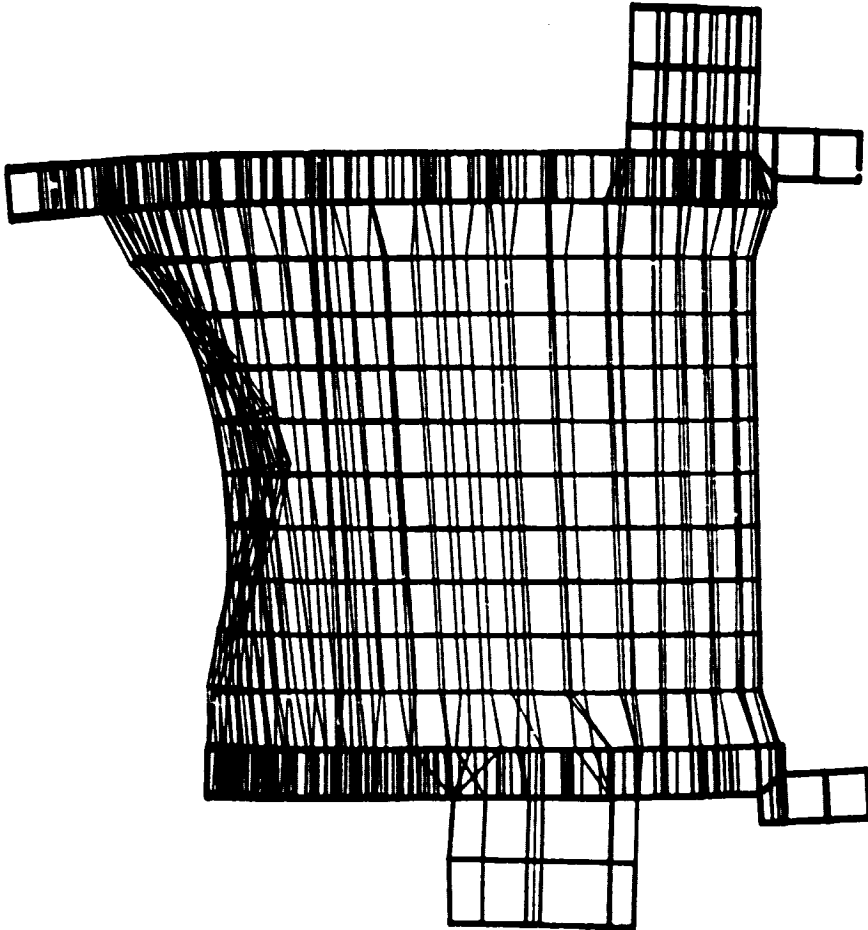

Fig. 3-18 Model F1, Mode 5, Freq 19017

C-2

ORIGINAL PAGE IS
OF POOR QUALITY

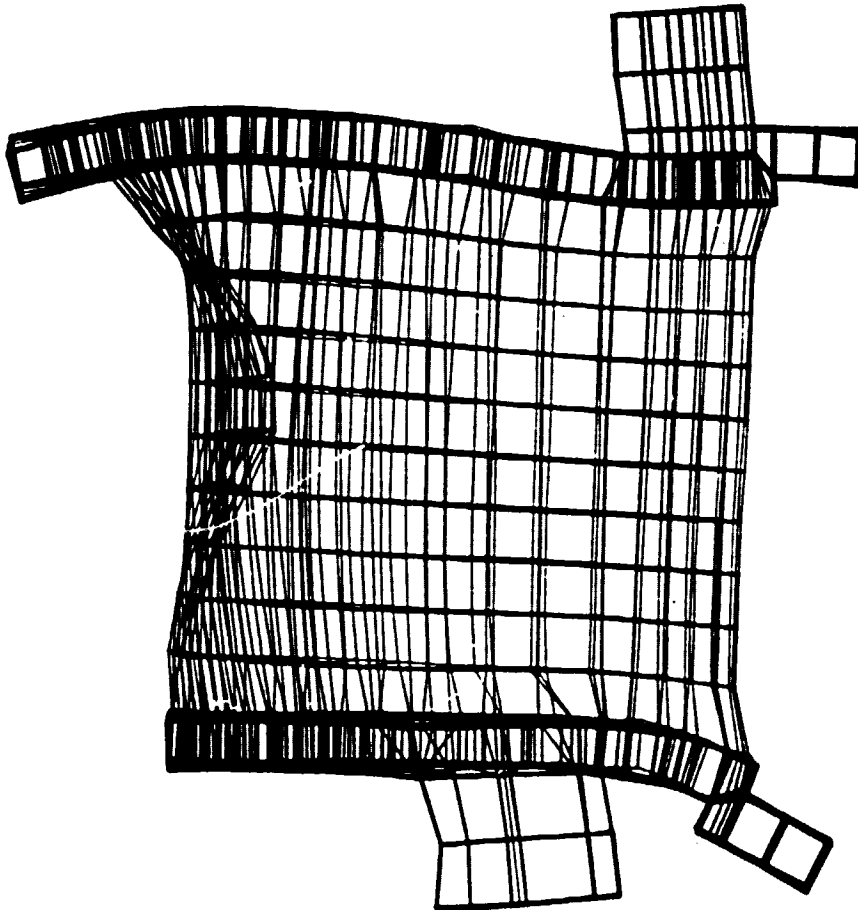

Fig. 3-19 Model F1, Mode 6, Freq 20148

ORIGINAL PAGE IS
OF POOR QUALITY

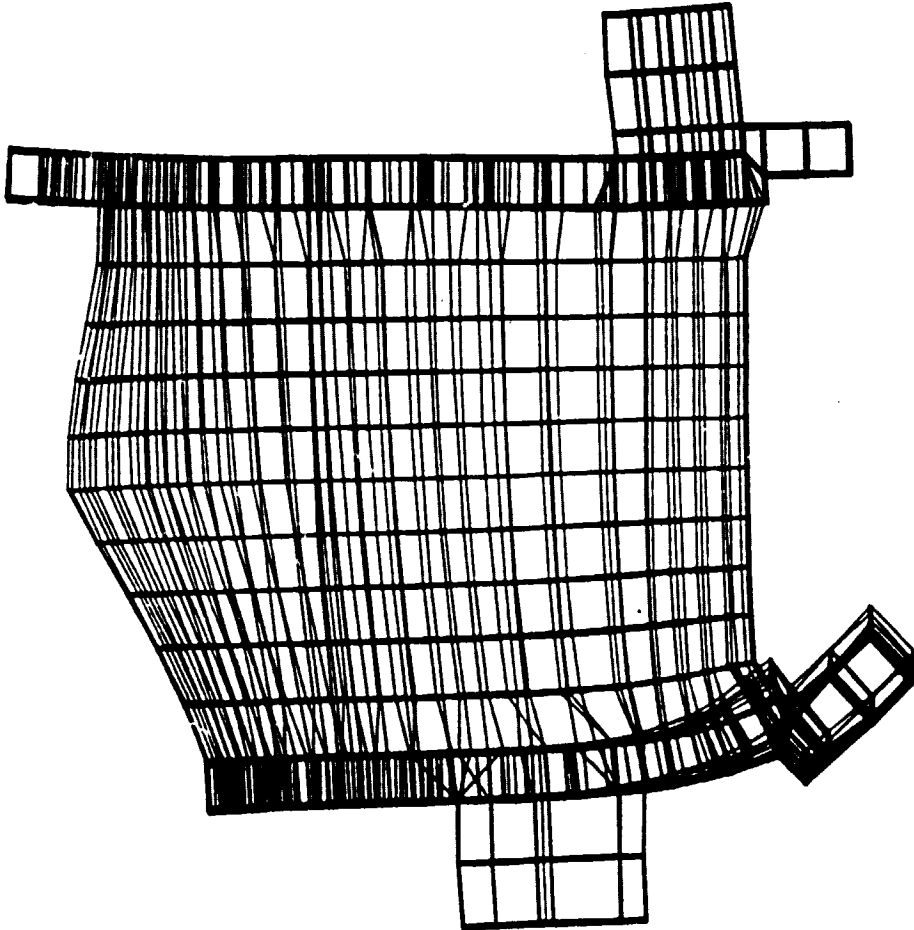

Fig. 3-20 Model F1, Mode 7, Freq 26149

ORIGINAL PAGE IS
OF POOR QUALITY

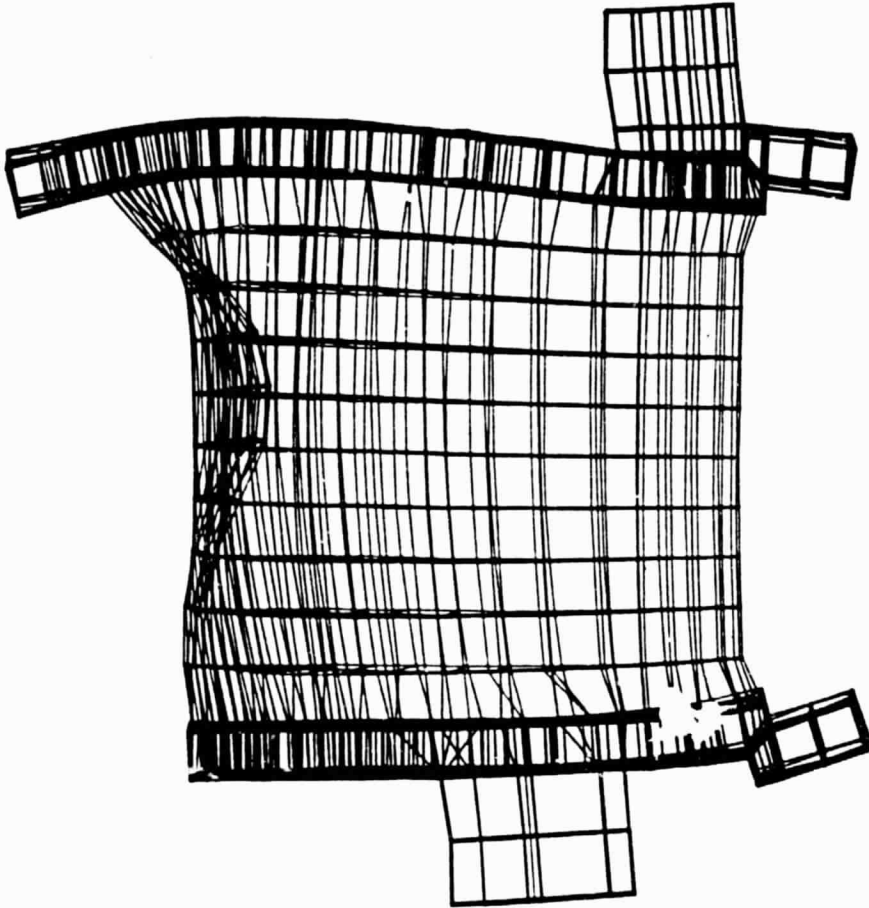

Fig. 3-21 Model F1, Mode 8, Freq 28266

**ORIGINAL PAGE IS
OF POOR QUALITY**

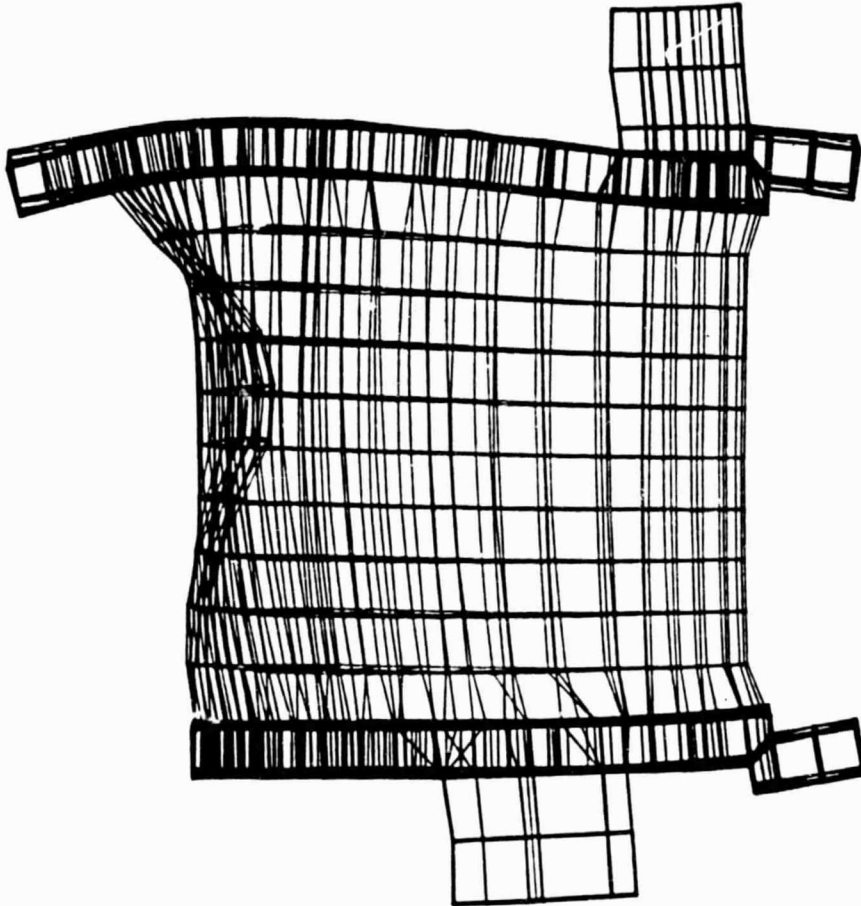

Fig. 3-22 Model F1, Mode 9, Freq 29037

ORIGINAL PAGE IS
OF POOR QUALITY

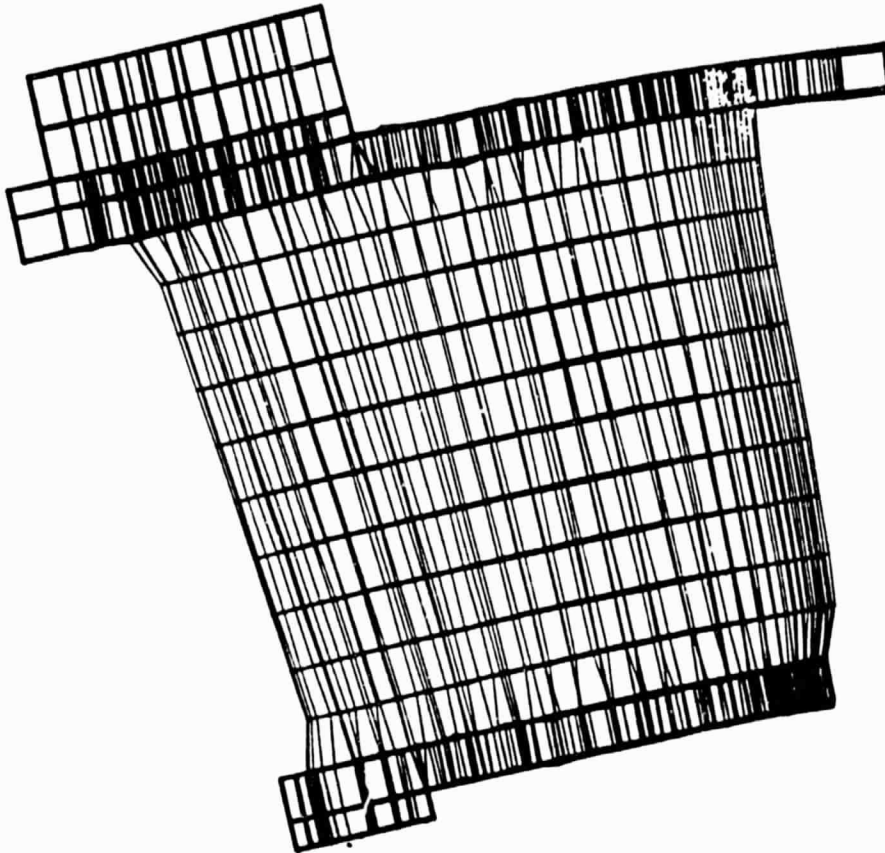

Fig. 3-23 Model F2, Mode 1, Freq 2726

ORIGINAL PAGE IS
OF POOR QUALITY

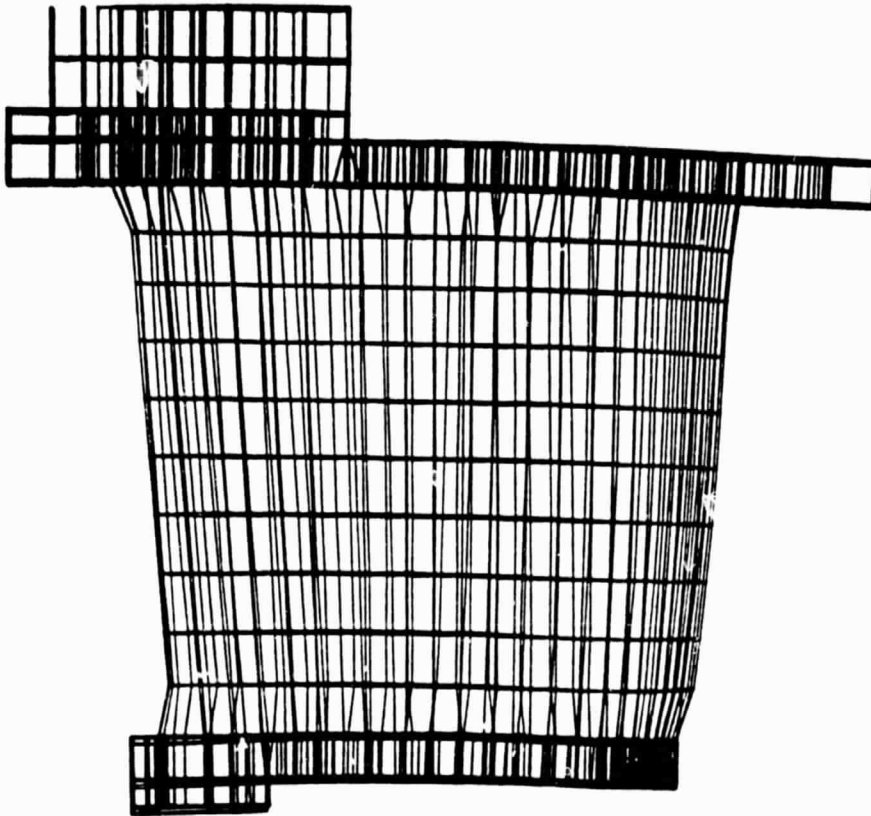

Fig. 3-24 Model F2, Mode 2, Freq 3371

ORIGINAL PAGE IS
OF POOR QUALITY

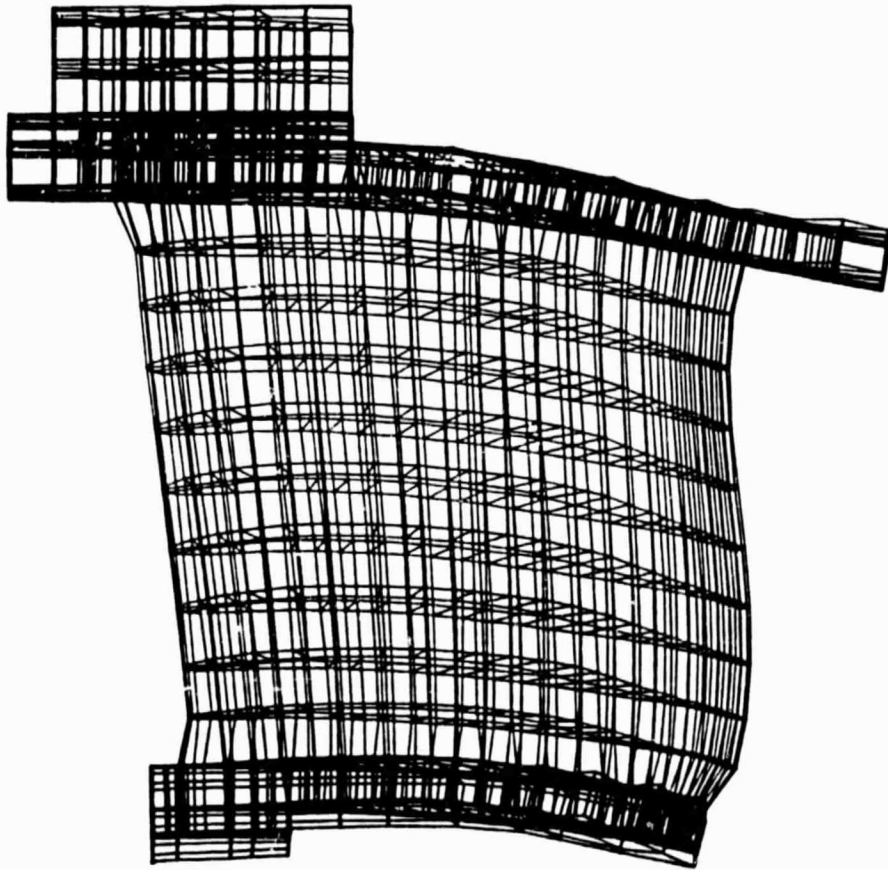

Fig. 3-25 Model F2, Mode 3, Freq 6104

ORIGINAL PAGE 19
OF POOR QUALITY

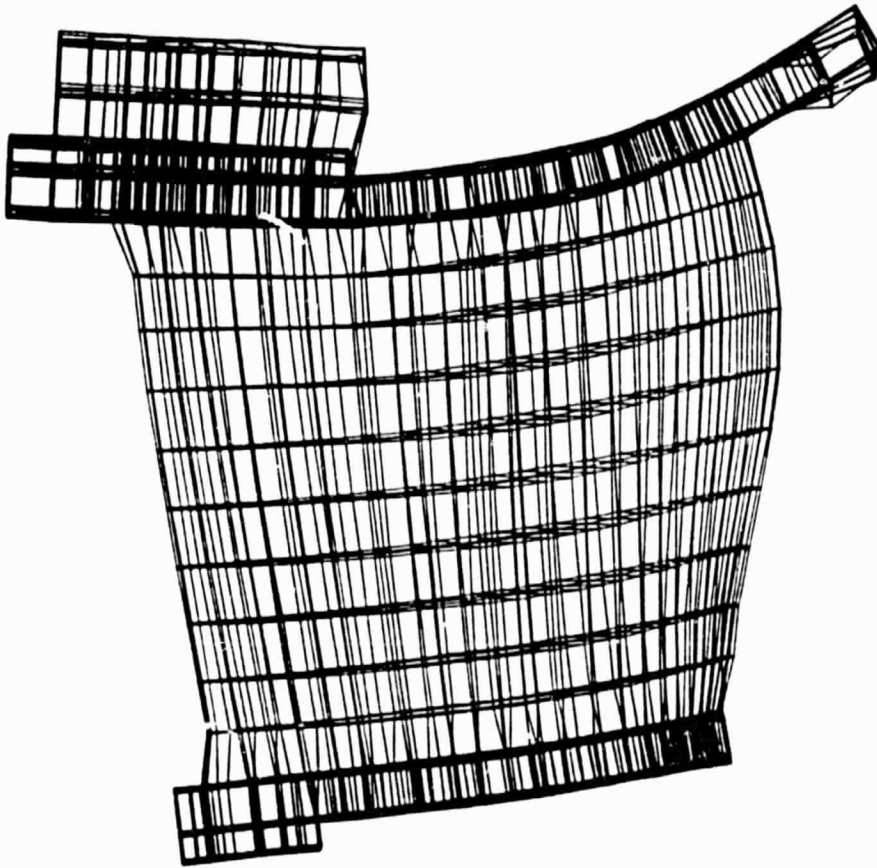

Fig. 3-26 Model F2, Mode 4, Freq 14698

ORIGINAL PAGE IS
OF POOR QUALITY

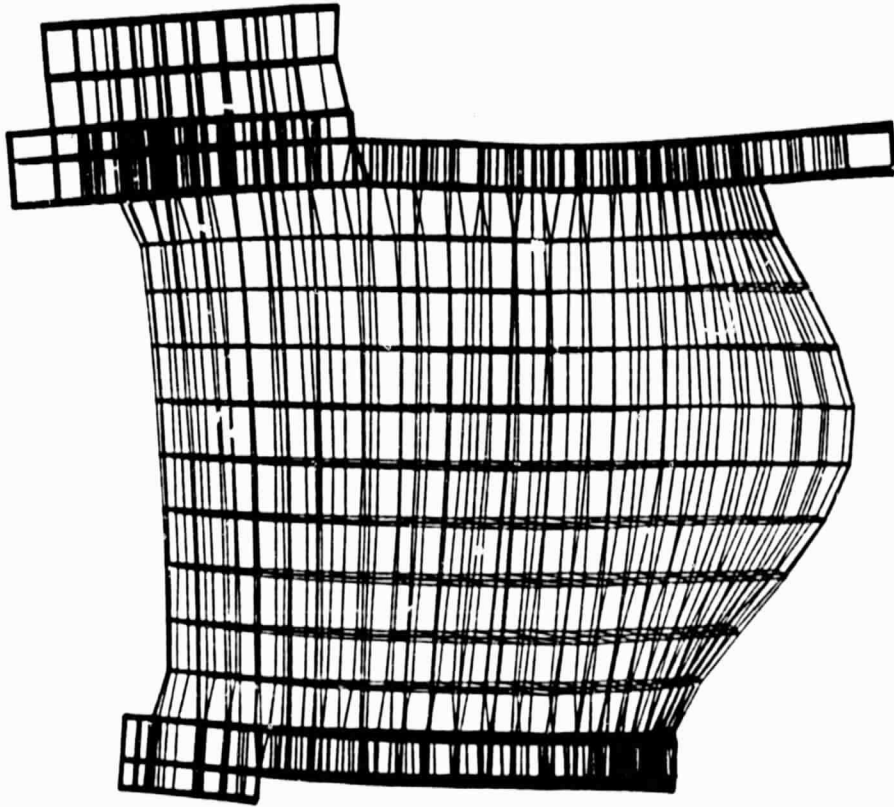

Fig. 3-27 Model F2, Mode 5, Freq 15955

ORIGINAL PAGE IS
OF POOR QUALITY

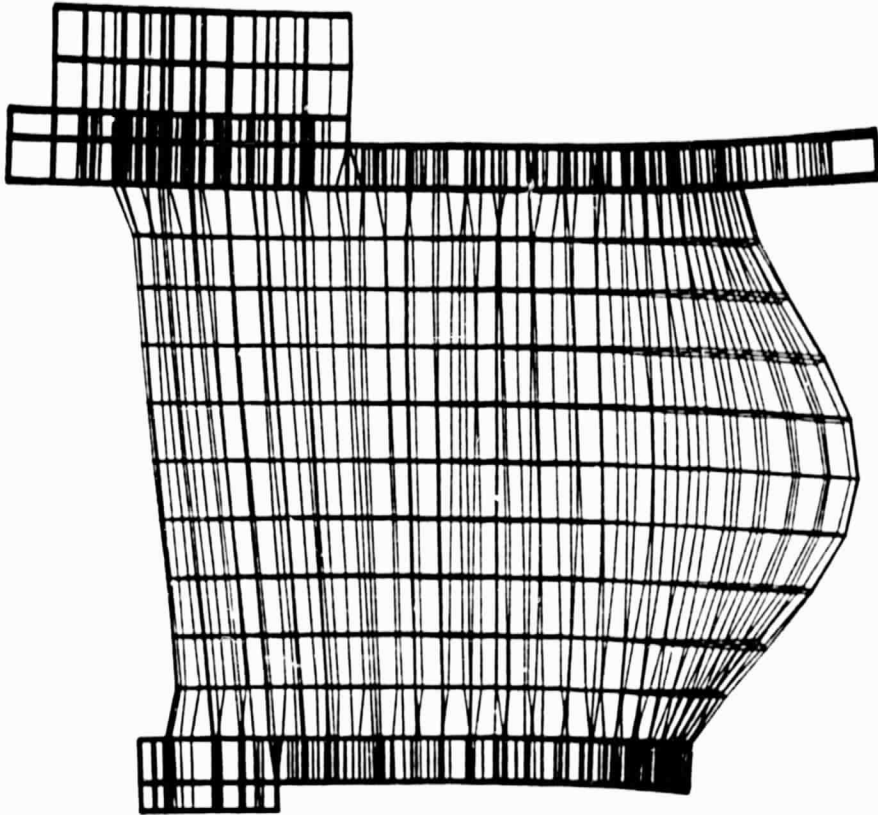

Fig. 3-28 Model F2, Mode 6, Freq 18375

ORIGINAL PAGE IS
OF POOR QUALITY

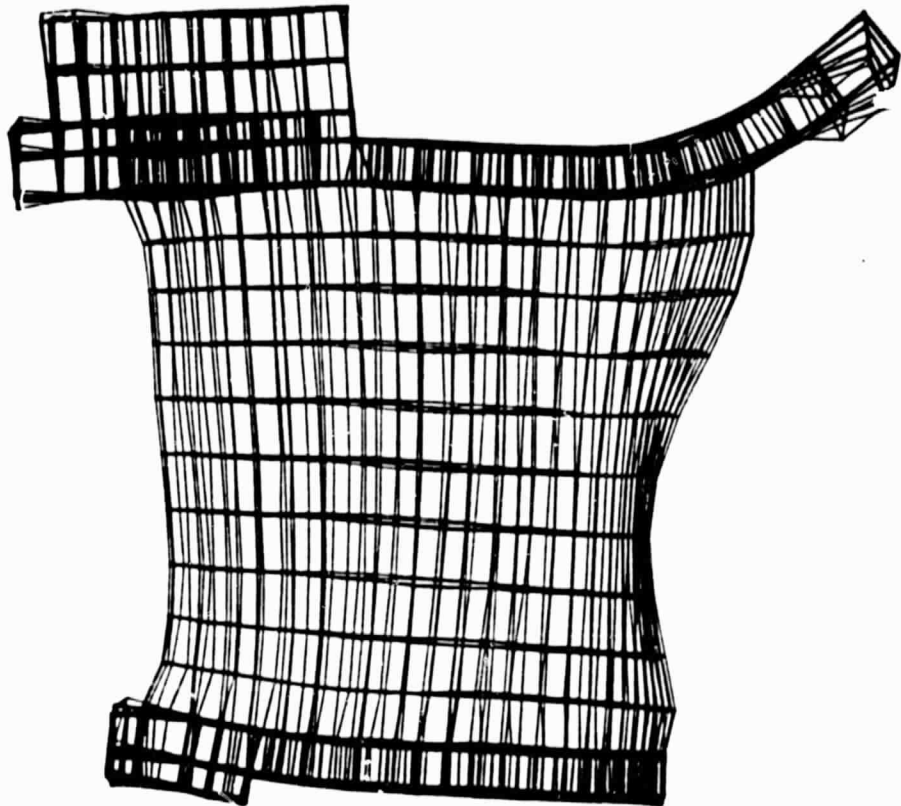

Fig. 3-29 Model F2, Mode 7, Freq 21334

ORIGINAL PAGE IS
OF POOR QUALITY

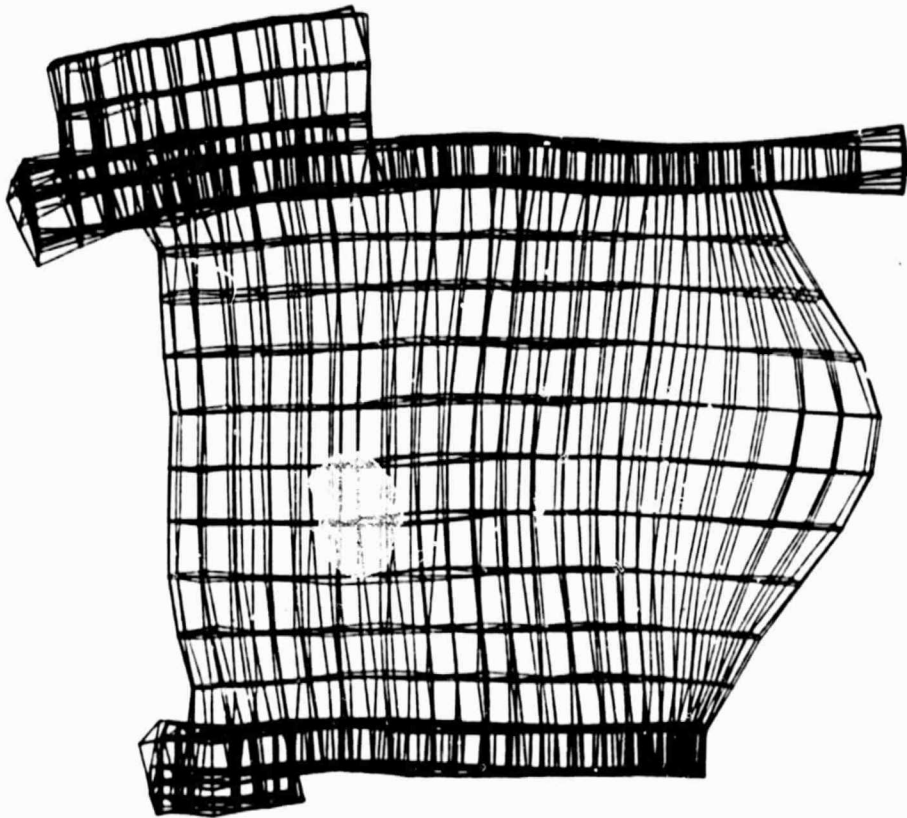

Fig. 3-30 Model F2, Mode 8, Freq 26211

ORIGINAL PAGE IS
OF POOR QUALITY

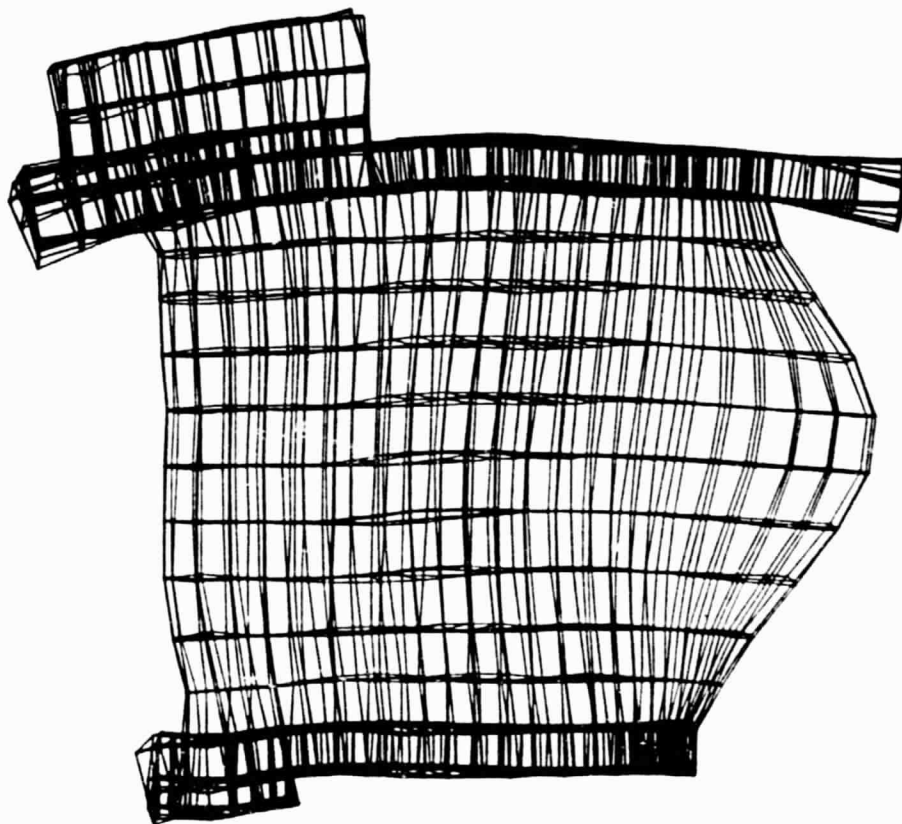

Fig. 3-31 Model F2, Mode 9, Freq 27225

ORIGINAL PAGE 19
OF POOR QUALITY

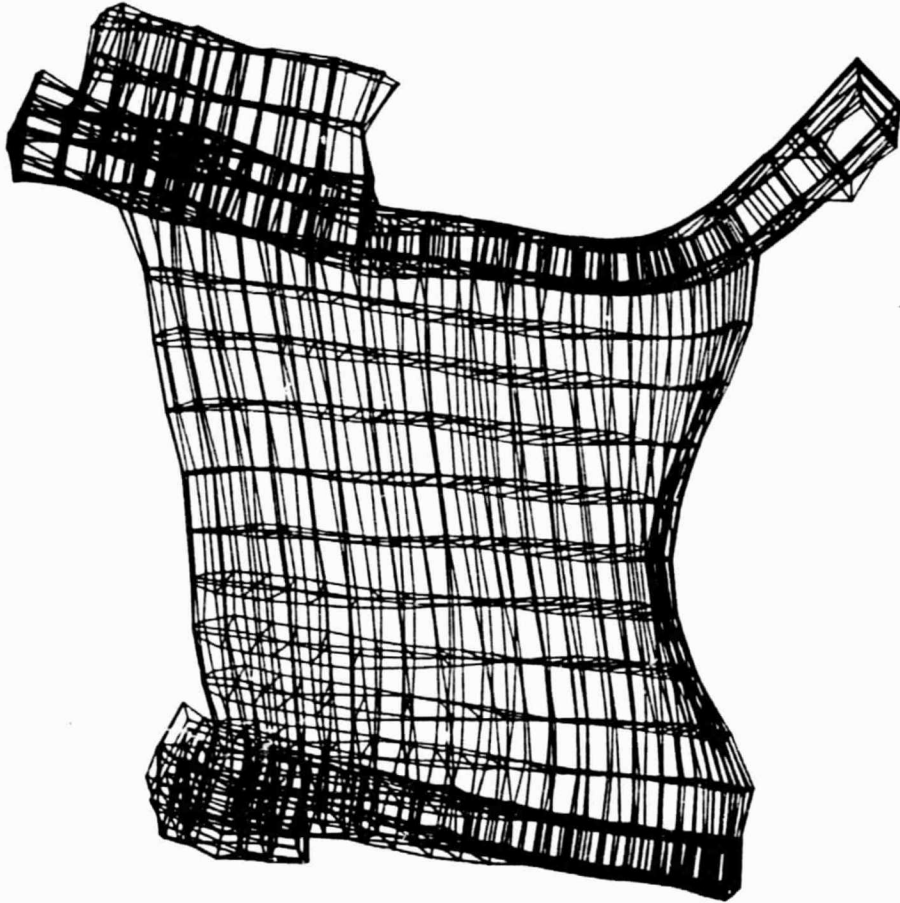

Fig. 3-32 Model F2, Mode 10, Freq 30403

ORIGINAL PAGE IS
OF POOR QUALITY

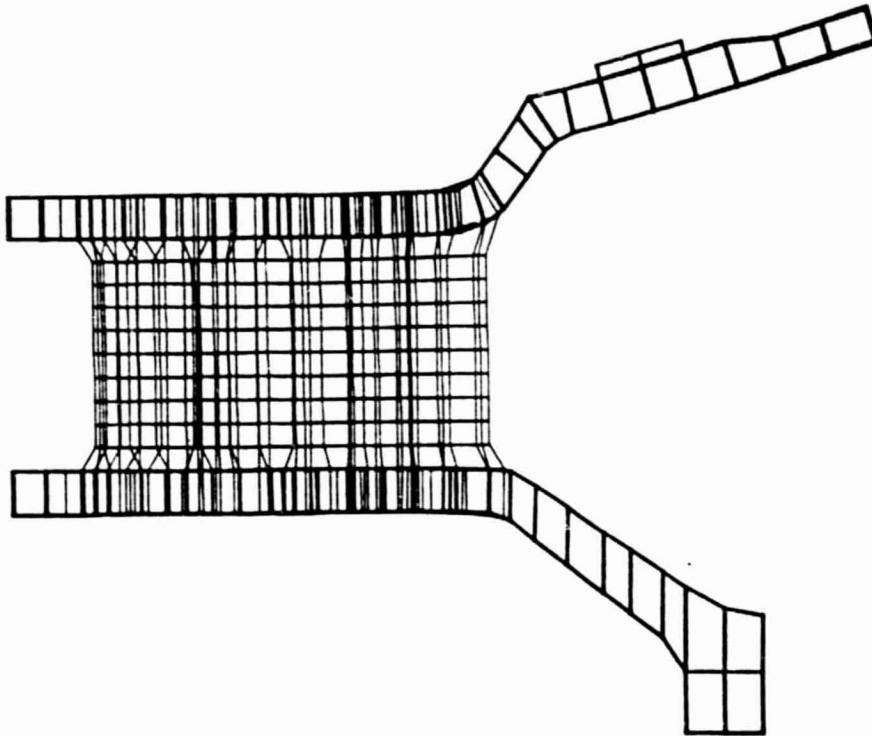

Fig. 3-33 Model 01, Mode 1, Freq 3262

ORIGINAL PAGE IS
OF POOR QUALITY

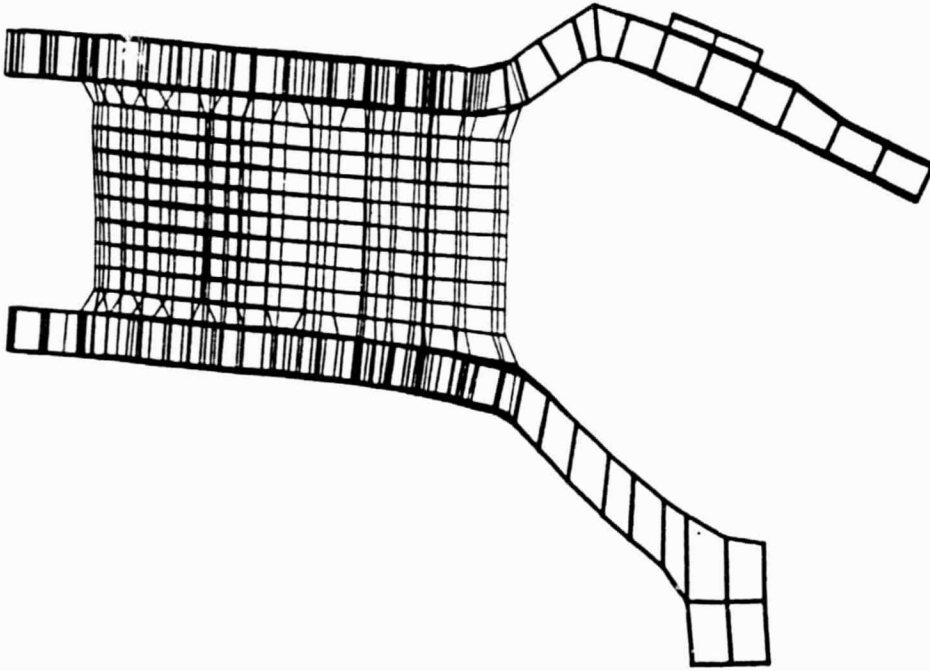

Fig. 3-34 Model 01, Mode 2, Freq 5445

ORIGINAL PAGE IS
OF POOR QUALITY

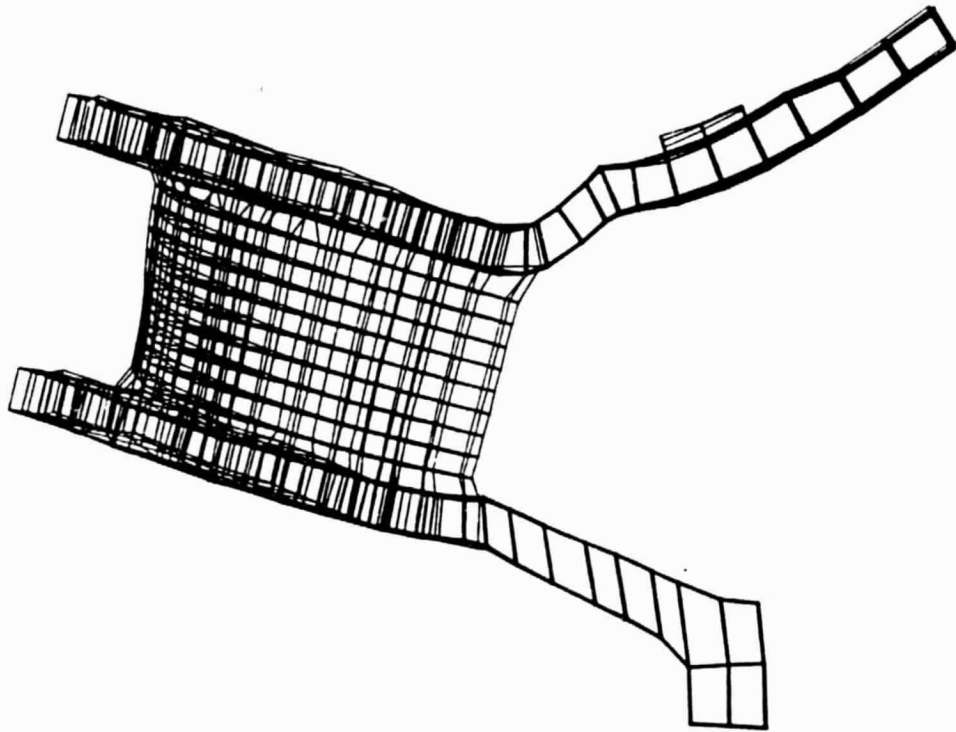

Fig. 3-35 Model 01, Mode 3, Freq 10777

ORIGINAL PAGE IS
OF POOR QUALITY

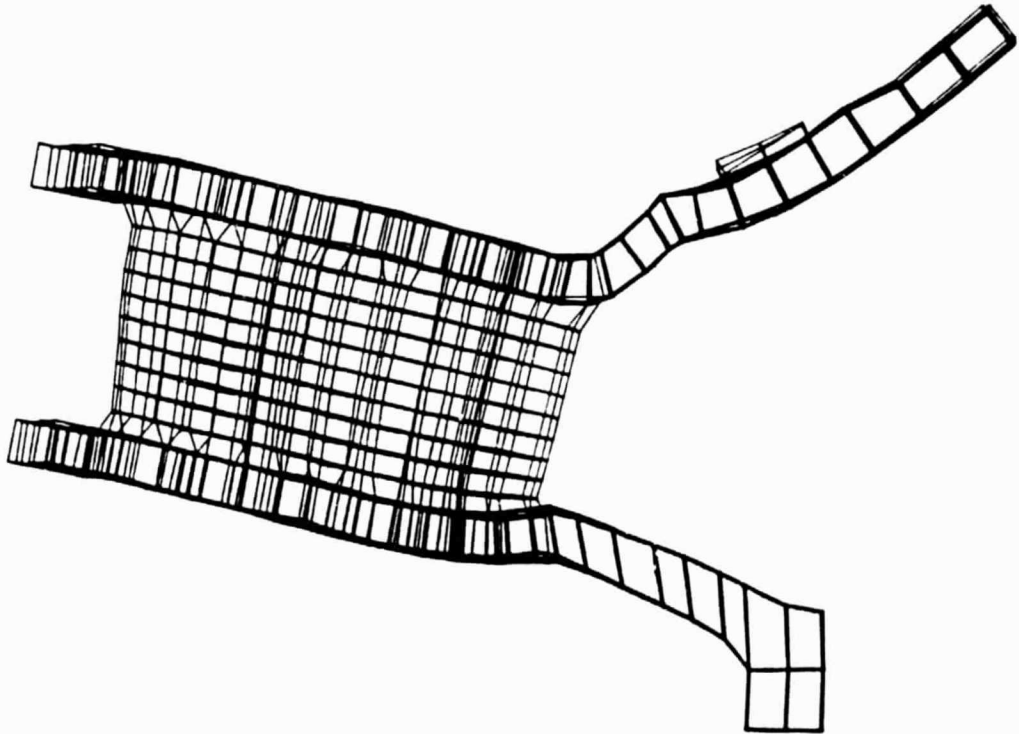

Fig. 3-36 Model 01, Mode 4, Freq 11049

ORIGINAL PAGE IS
OF POOR QUALITY

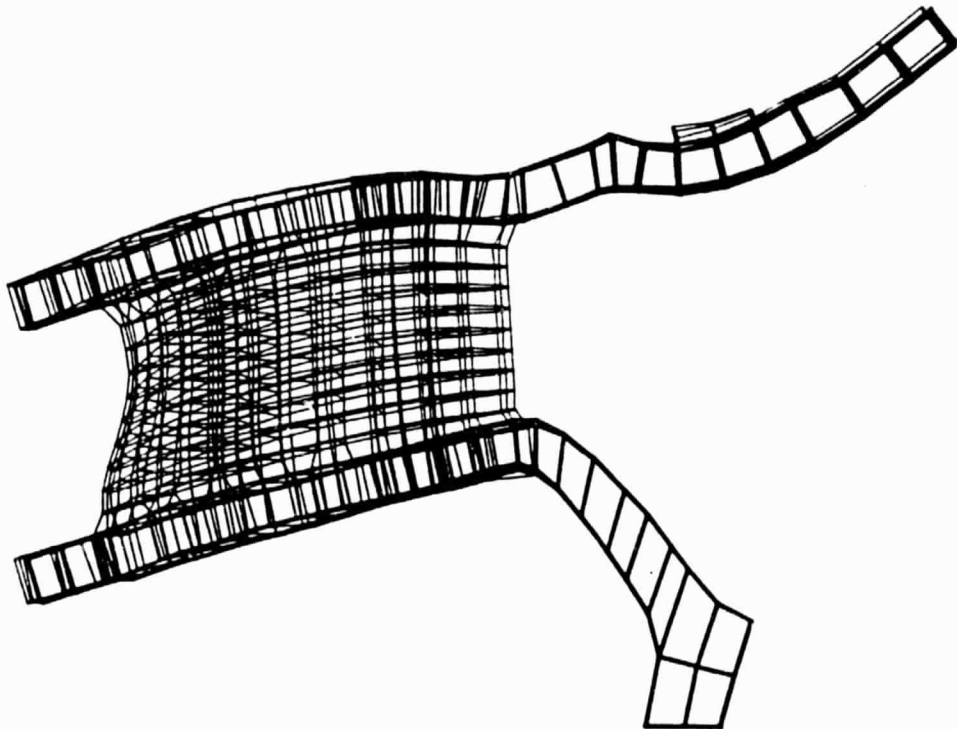

Fig. 3-37 Model 01, Mode 5, Freq 14505

ORIGINAL PAGE IS
OF POOR QUALITY

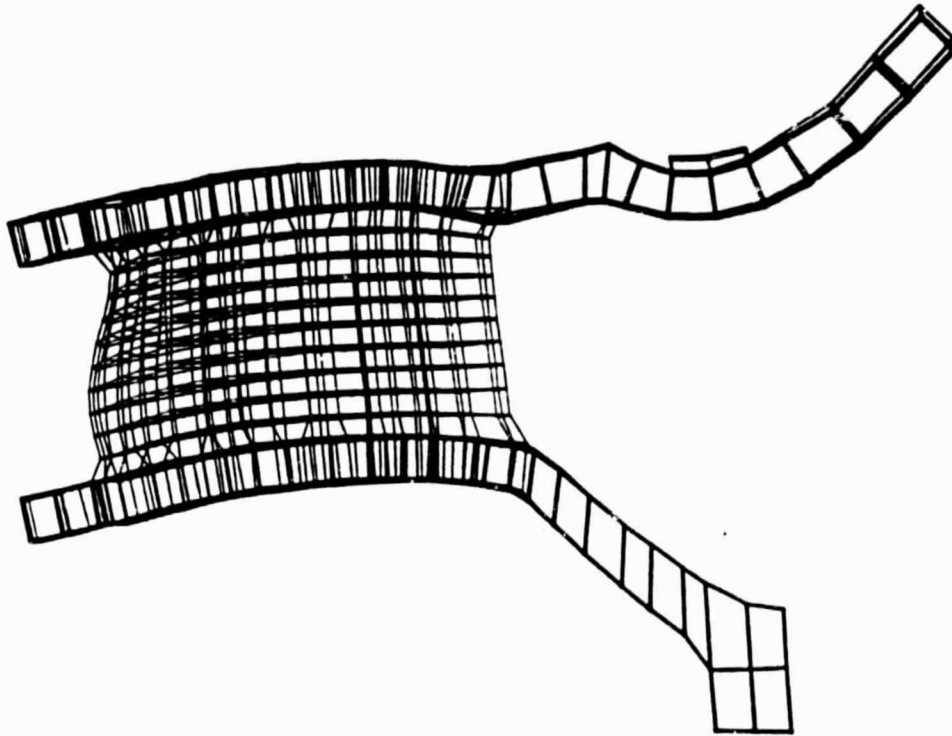

Fig. 3-38 Model 01, Mode 6, Freq 21374

ORIGINAL PAGE IS
OF POOR QUALITY

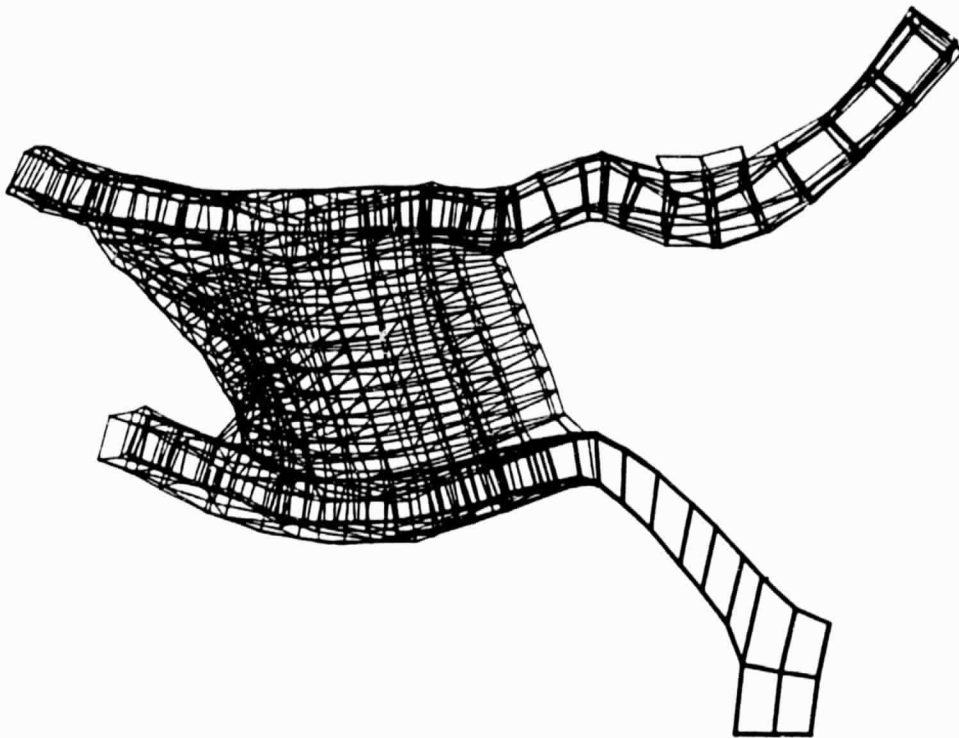

Fig. 3-39 Model 01, Mode 7, Freq 23895

ORIGINAL PAGE IS
OF POOR QUALITY

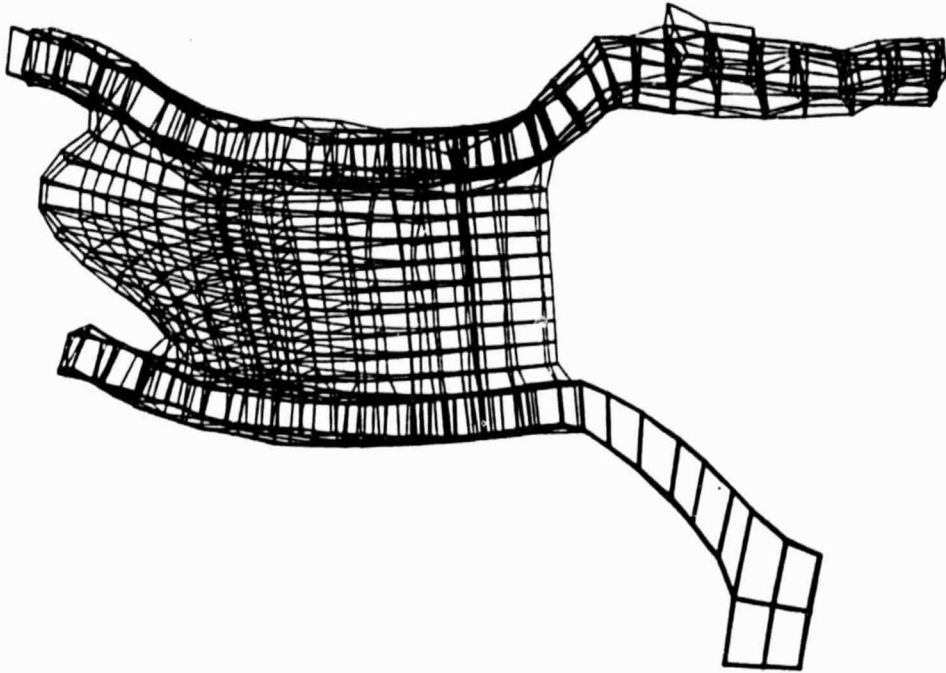

Fig. 3-40 Model 01, Mode 8, Freq 28514

ORIGINAL PAGE IS
OF POOR QUALITY

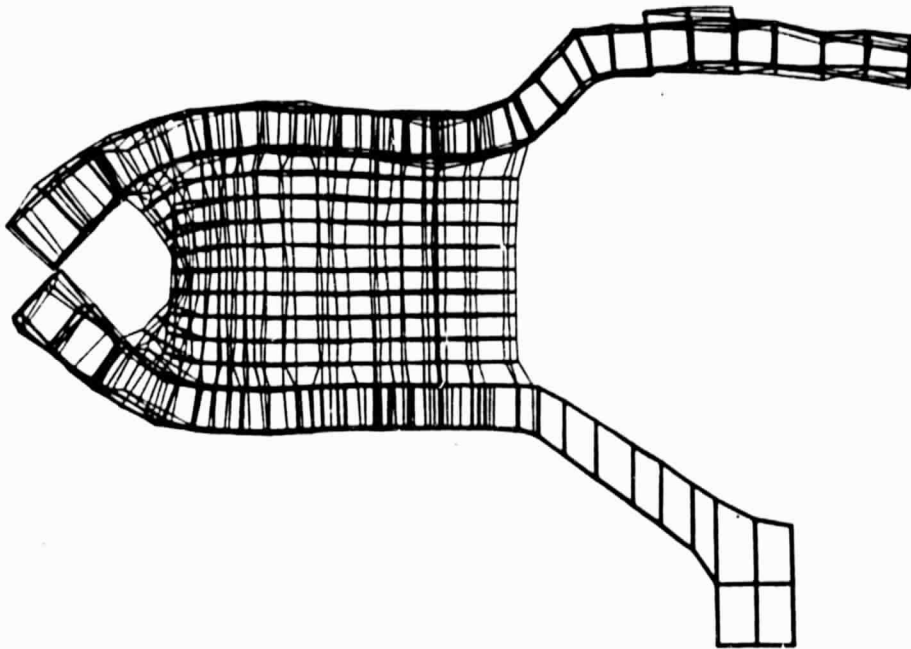

Fig. 3-41 Model 01, Mode 9, Freq 34686

ORIGINAL PAGE IS
OF POOR QUALITY

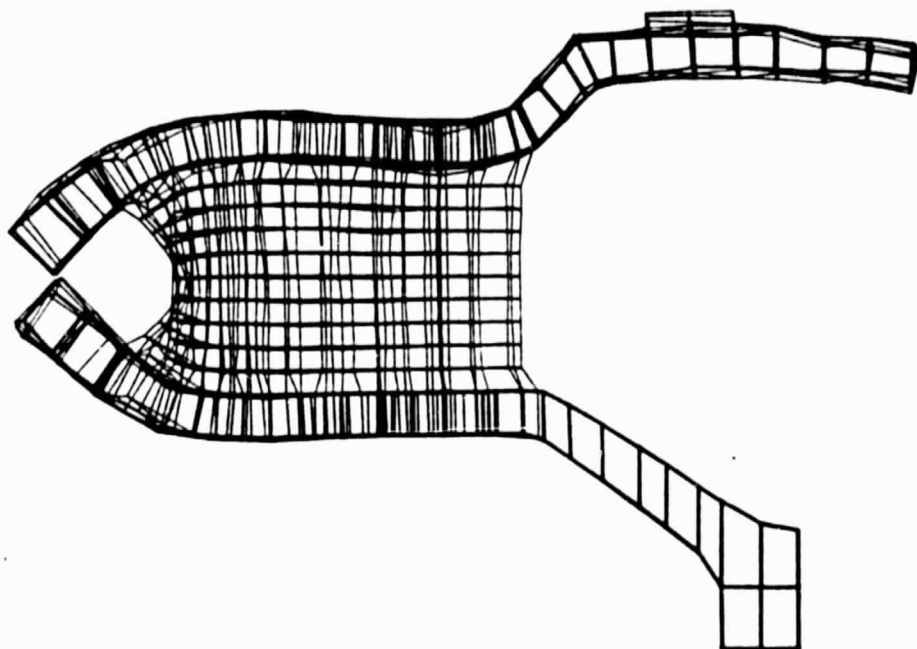

Fig. 3-42 Model 01, Mode 10, Freq 35871

ORIGINAL PAGE IS
OF POOR QUALITY

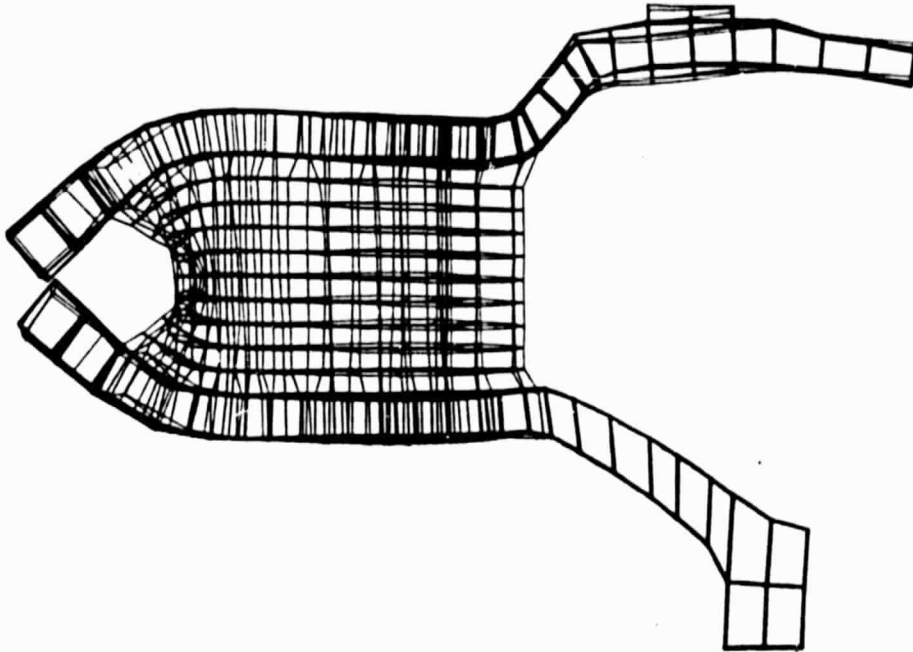

Fig. 3-43 Model 01, Mode 11, Freq 39171

ORIGINAL PAGE 19
OF POOR QUALITY

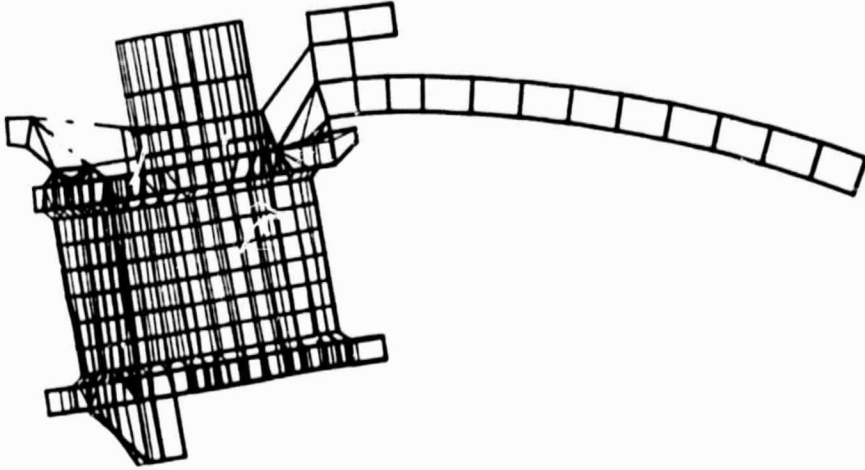

Fig. 3-44 Model O2, Mode 1, Freq 3634

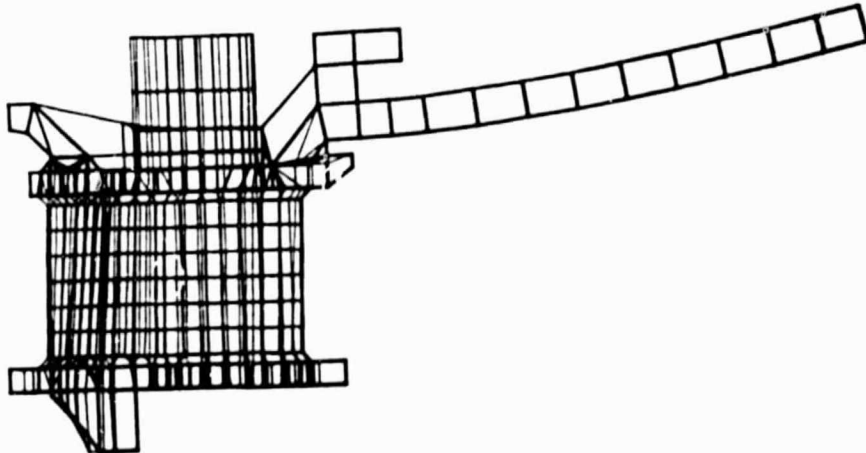

Fig. 3-45 Model O2, Mode 2, Freq 5006

ORIGINAL PAGE IS
OF POOR QUALITY

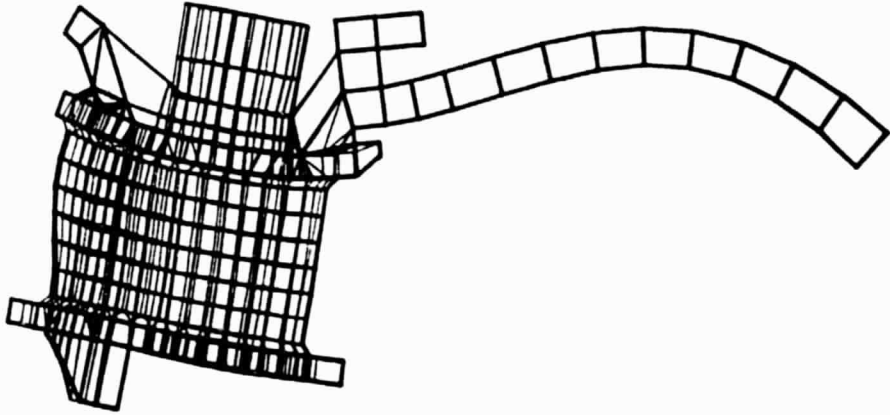

Fig. 3-46 Model O2, Mode 3, Freq 6204

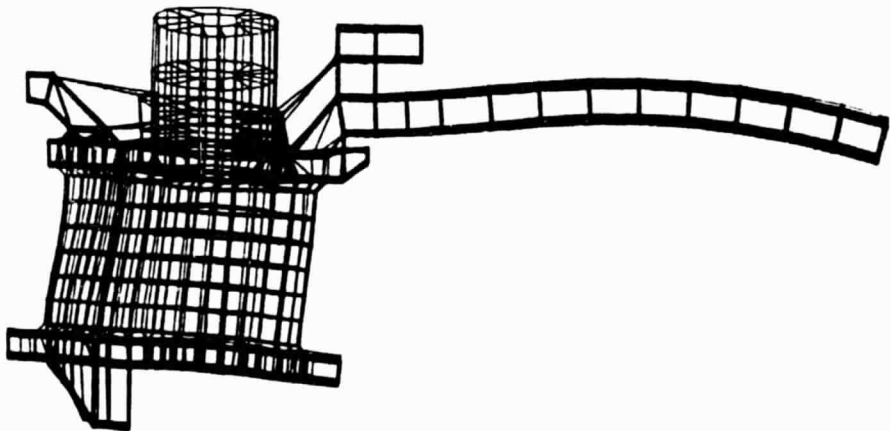

Fig. 3-47 Model O2, Mode 4, Freq 7562

ORIGINAL PAGE IS
OF POOR QUALITY

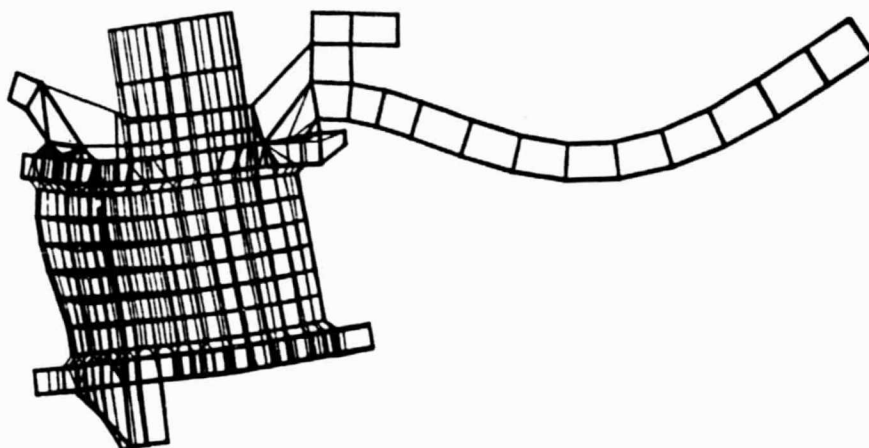

Fig. 3-48 Model 02, Mode 5, Freq 9176

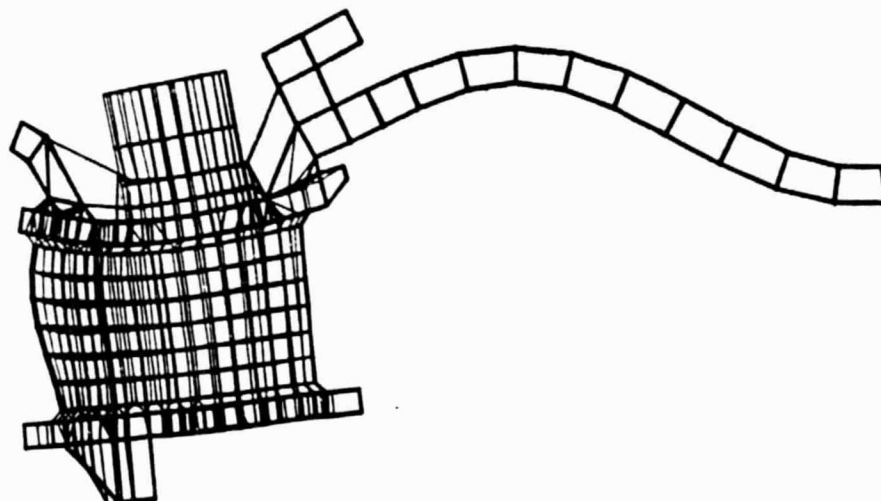

Fig. 3-49 Model 02, Mode 6, Freq 10146

ORIGINAL PAGE IS
OF POOR QUALITY

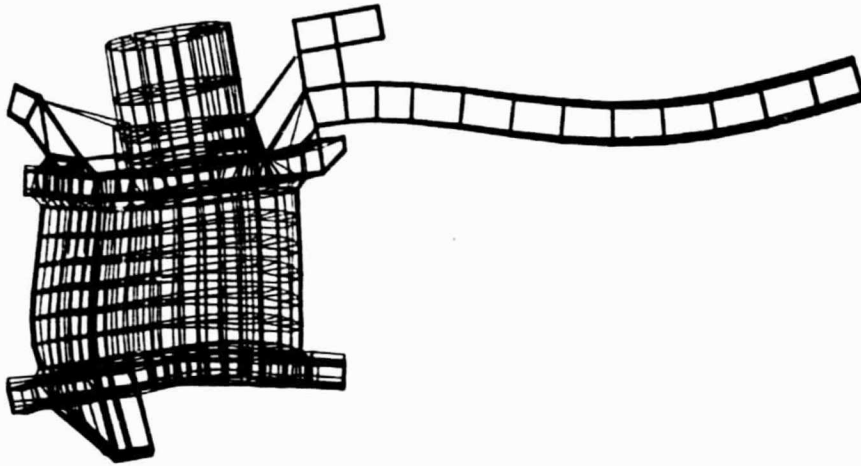

Fig. 3-50 Model 02, Mode 7, Freq 11748

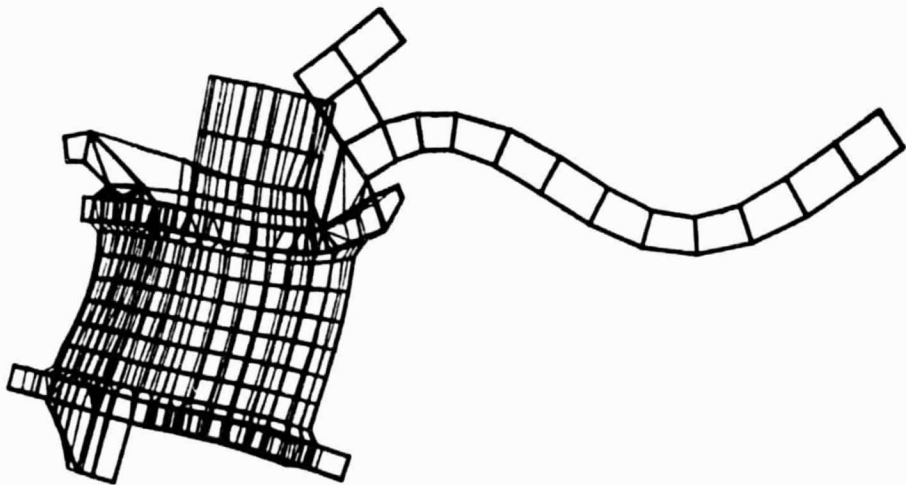

Fig. 3-51 Model 02, Mode 8, Freq 15554

ORIGINAL PAGE IS
OF POOR QUALITY

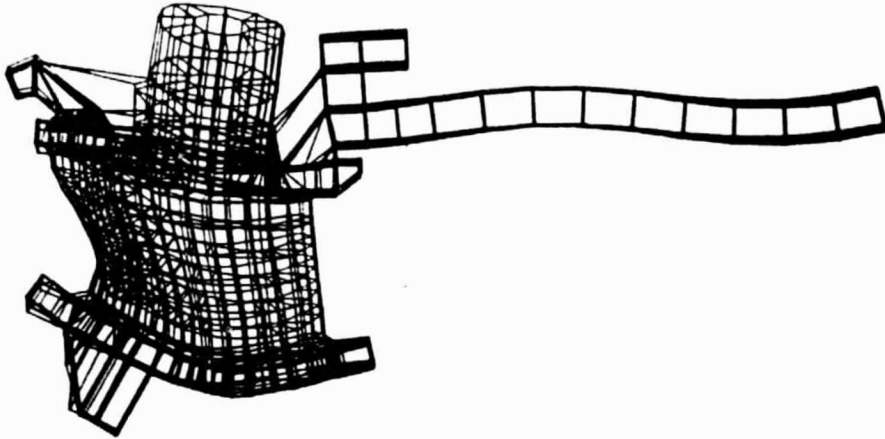

Fig. 3-52 Model 02, Mode 9, Freq 20837

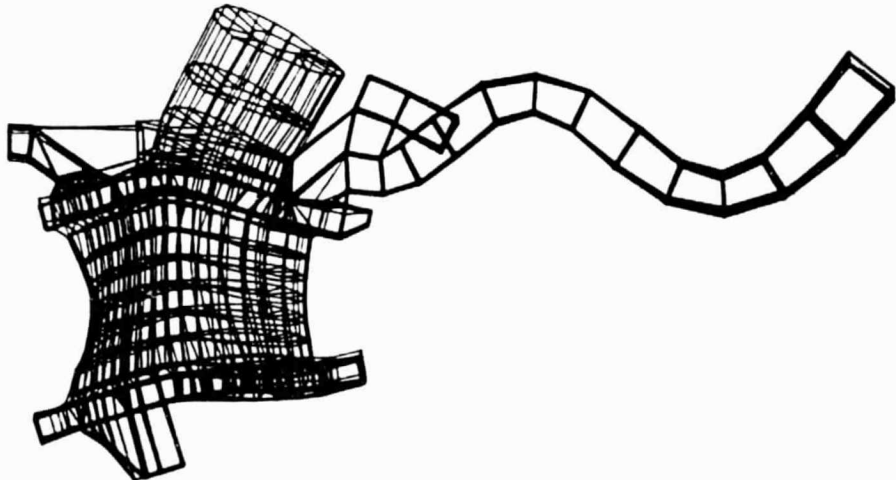

Fig. 3-53 Model 02, Mode 10, Freq 24911

ORIGINAL PAGE 19
OF POOR QUALITY



Fig. 3-54 Model 02, Mode 11, Freq 25737

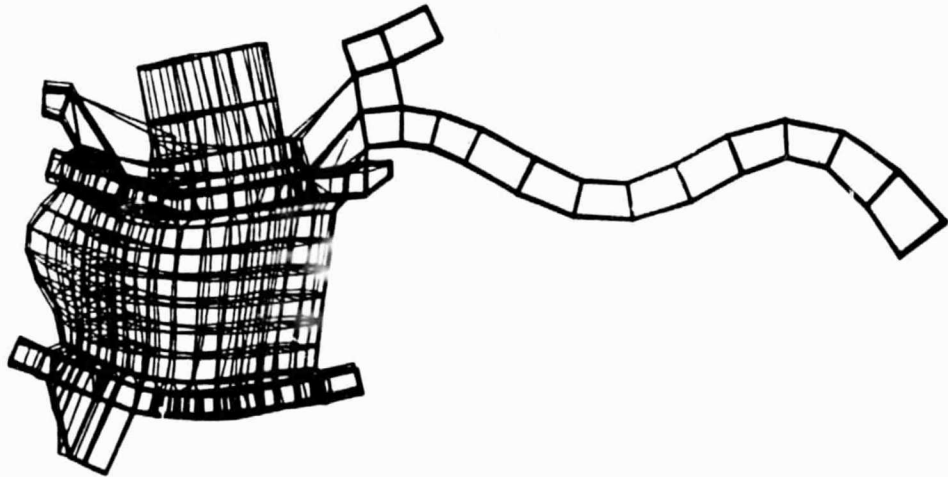

Fig. 3-55 Model 02, Mode 12, Freq 26562

ORIGINAL PAGE IS
OF POOR QUALITY



Fig. 3-56 Model 02, Mode 13, Freq 30007